

REP.	REFERENCE	PDS	NB	MZ
1	2085.7001	2,4	1	140
2	2085.7002	2,4	1	140
3	2085.7003	2,1	2	
4	2085.7004	0,4	2	
5	2085.7005	4,8	1	601
6	2085.7006	4,8	1	602
7	2085.7007	3,9	1	
8	2085.7008	3,9	1	
9	2085.7009	0,6	2	
10	2085.7010	2,8	1	260
11	2085.7011	2,8	1	260
12	2085.7012	1,8	1	140/080
13	2085.7013	1,8	1	140/080
14	2085.7014	1,3	1	142
15	2085.7015	1,3	1	141
16	2085.7016	1,2	1	140
17	2085.7017	1,2	1	140
18	2085.7018	2,8	1	200
19	2085.7019	2,8	1	200
20	2085.7020	3,1	1	602
21	2085.7021	3,1	1	601
22	2085.7022	3,0	1	200
23	2085.7023	3,0	1	200
24	2085.7024	2,5	1	260
25	2085.7025	2,5	1	260
26	2085.7026	2,7	1	260
27	2085.7027	2,7	1	260

	M 12-25	6
	M 14-25	2
	M 10x1,25-25	4
	M 14x1,50-80	2
	M 14x1,50-120	2
	M 14x1,50-150	2
M 14x1,50-160	2	
M 14x1,50-180	2	

	LU 10	4
--	-------	---

○ Avec ou sans mécanique  
 With or without mechanical elements  
 Con o senza parti meccaniche  
 Mit oder ohne Aggregate  
 Con ó sin mecanica desmontada

**HYUNDAI**

**2085.300**

73 Kg 08.03.2006 447-D-18A

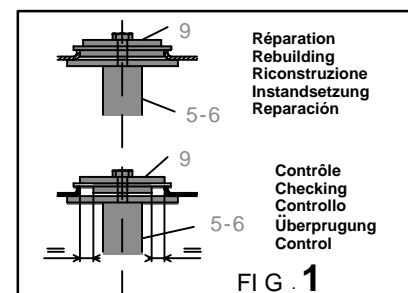
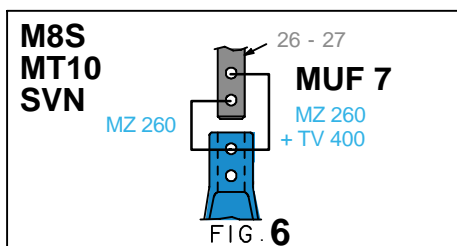
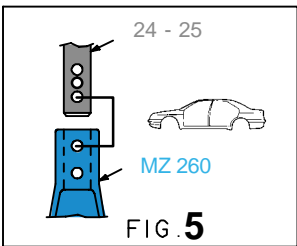
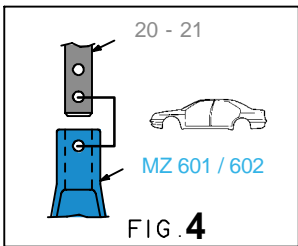
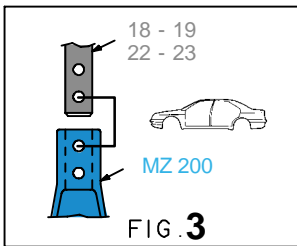
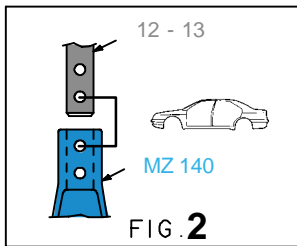
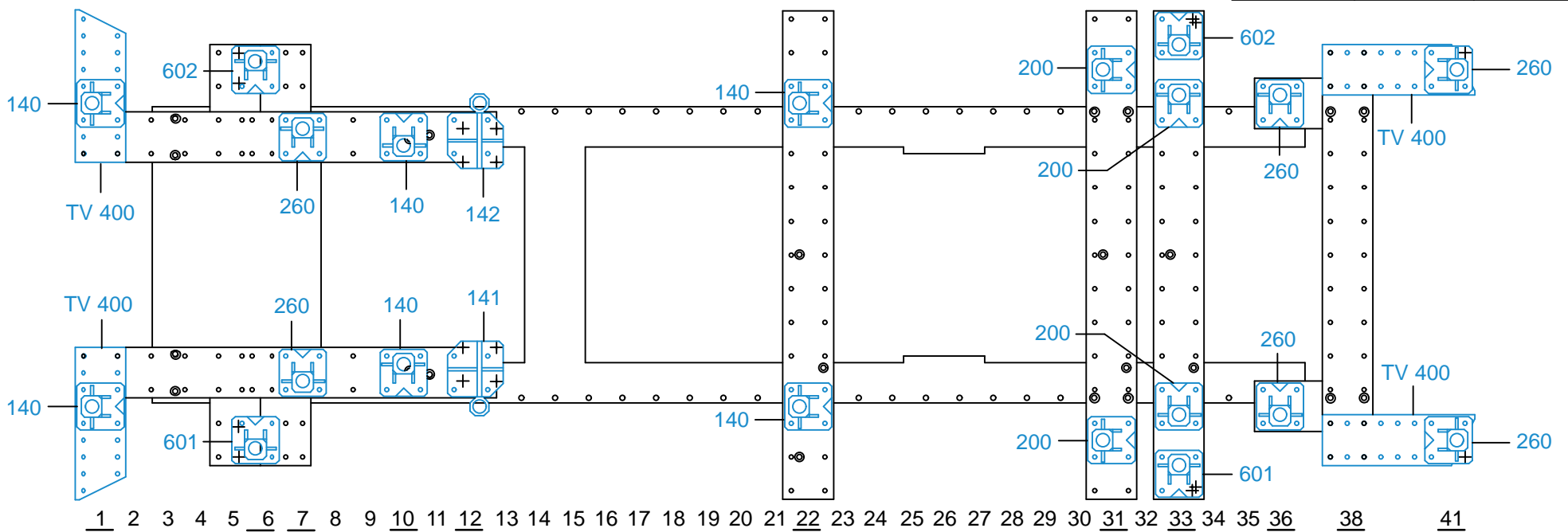

2085.300-RVA3-1 00

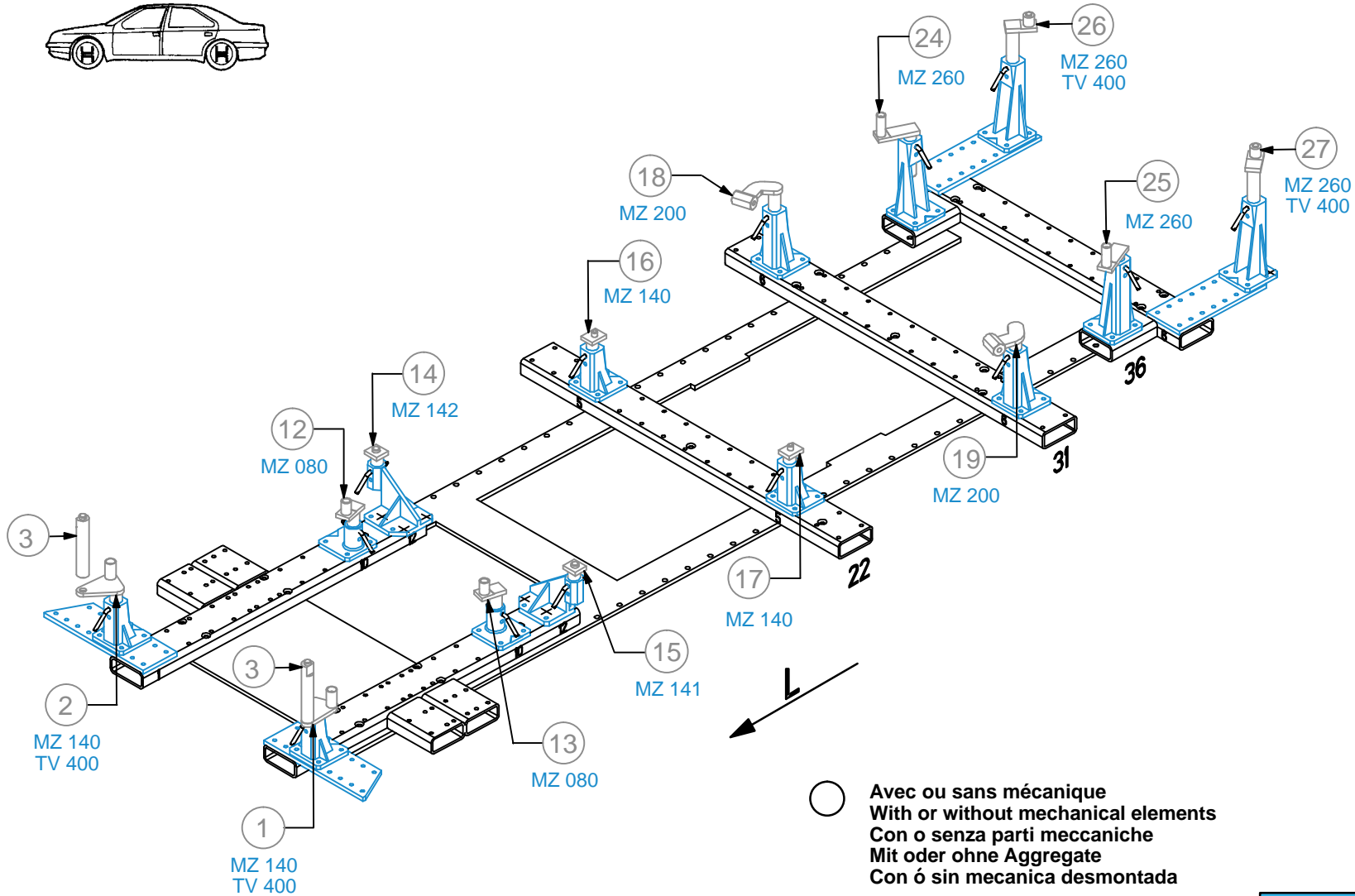
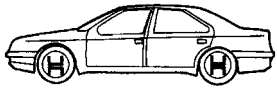

○ Avec ou sans mécanique  
 With or without mechanical elements  
 Con o senza parti meccaniche  
 Mit oder ohne Aggregate  
 Con ó sin mecánica desmontada

**HYUNDAI**

<b>2085.300</b>		
73 Kg	08.03.2006	447-D-18B

