

2WD

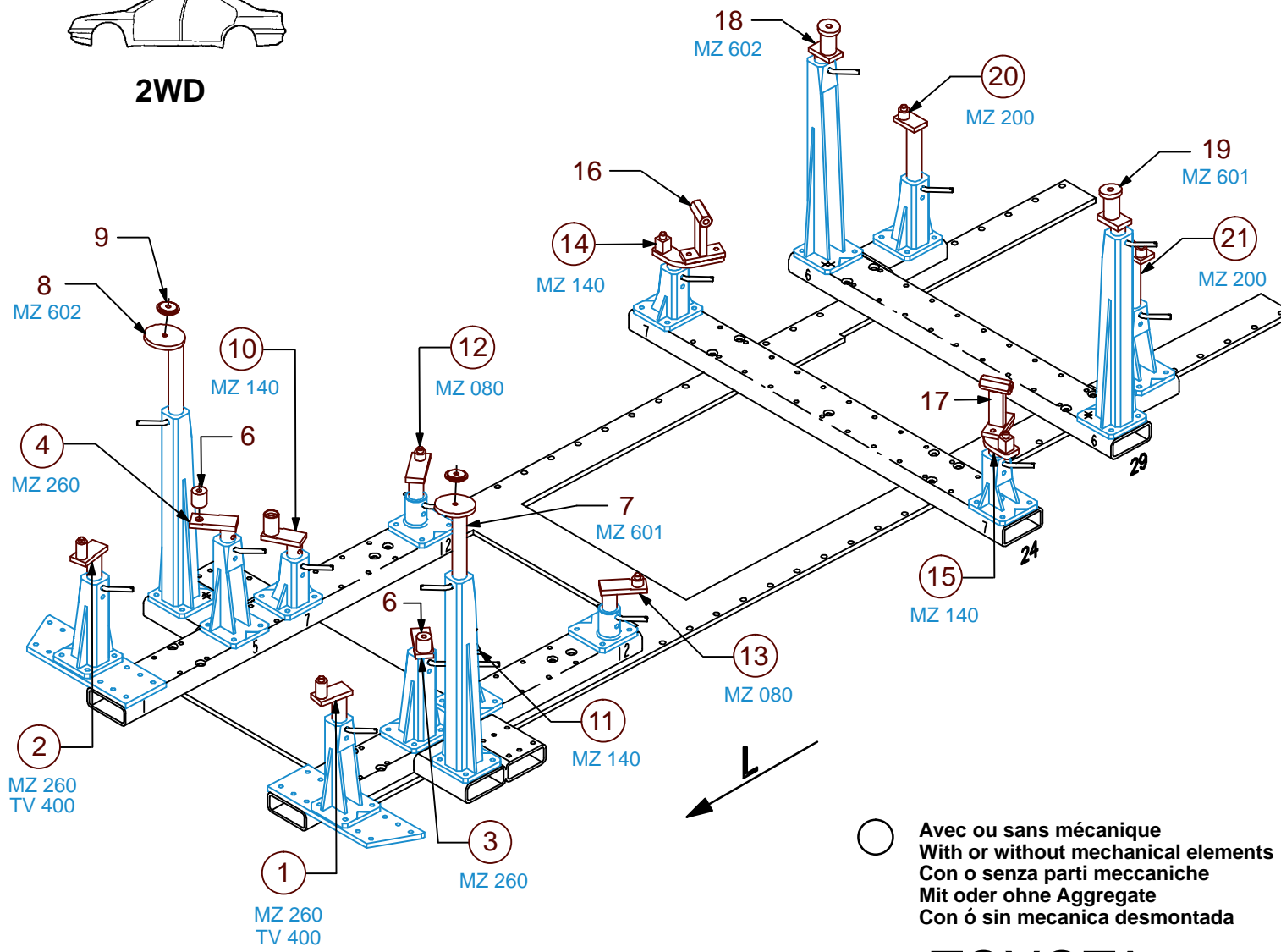

REP.	REFERENCE	PDS	NB	MZ
1	2077.7001	2,2	1	260
2	2077.7002	2,2	1	260
3	2077.7003	1,6	1	260/080
4	2077.7004	1,6	1	260/080
5	2077.7005	1,0	2	
6	2077.7006	0,4	2	
7	2077.7007	2,2	1	601
8	2077.7008	2,2	1	602
9	2077.7009	0,2	2	
10	2077.7010	1,9	1	140/080
11	2077.7011	1,9	1	140/080
12	2077.7012	1,9	1	080
13	2077.7013	1,9	1	080
14	2077.7014	2,2	1	140
15	2077.7015	2,2	1	140
16	2077.7016	1,7	1	
17	2077.7017	1,7	1	
18	2077.7018	1,8	1	602
19	2077.7019	1,8	1	601
20	2077.7020	2,8	1	200
21	2077.7021	2,8	1	200
22	2077.7022	2,1	1	200
23	2077.7023	2,2	1	200

M 12-20	2
M 12-40	6
M 12-80	2
M 16-20	2
M 12x1,25-90	2
M 14x1,50-100	2
M 14x1,50-110	2
M 14x1,50-160	2
M 14x1,50-200	2

M 12	6
MU 12	2

**TOYOTA**

**2077.300**

46 Kg 22.09.2008 434-D-84A

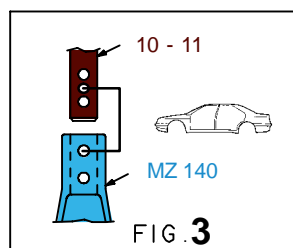
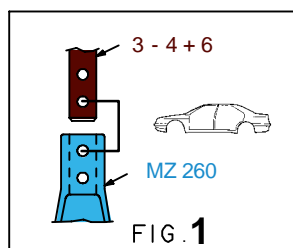
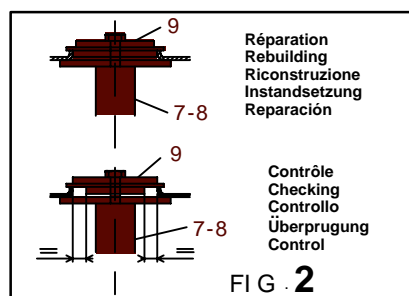
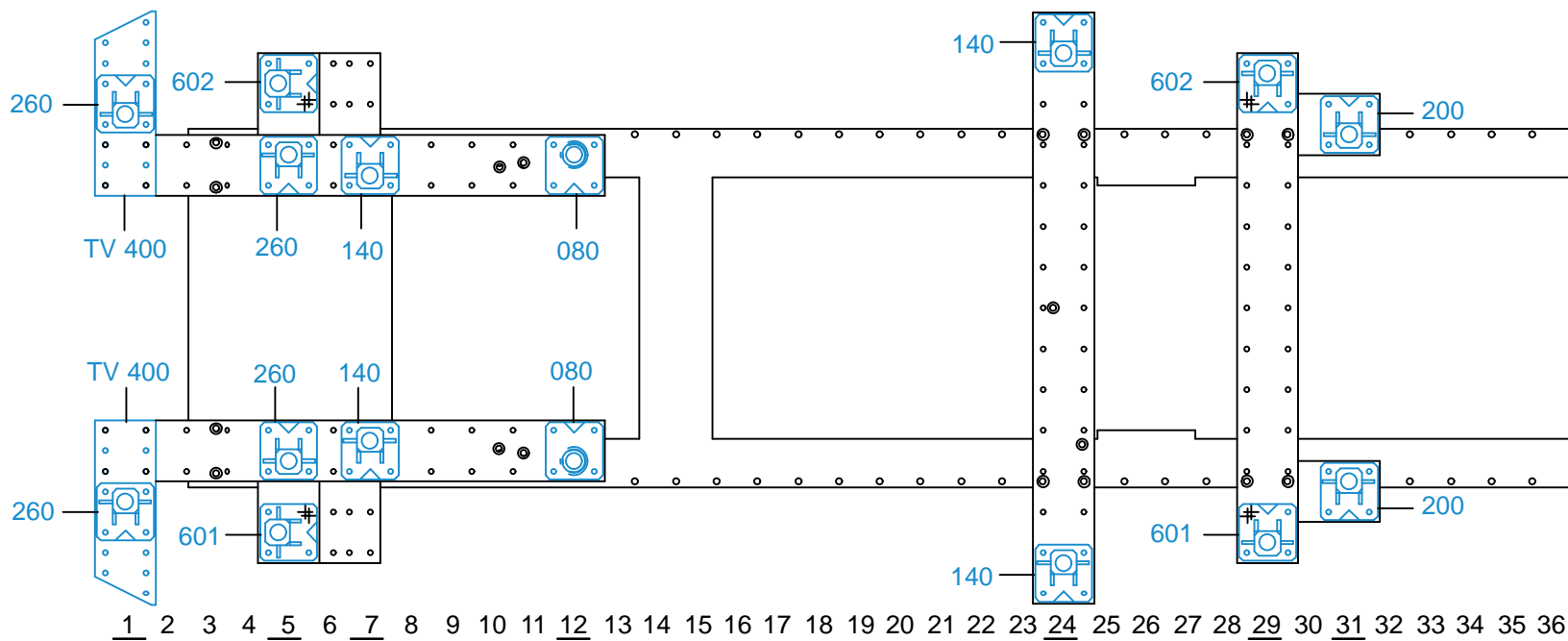

2077.300-RVA3-1 01

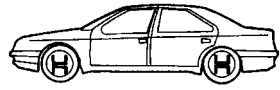

2WD  
4WD

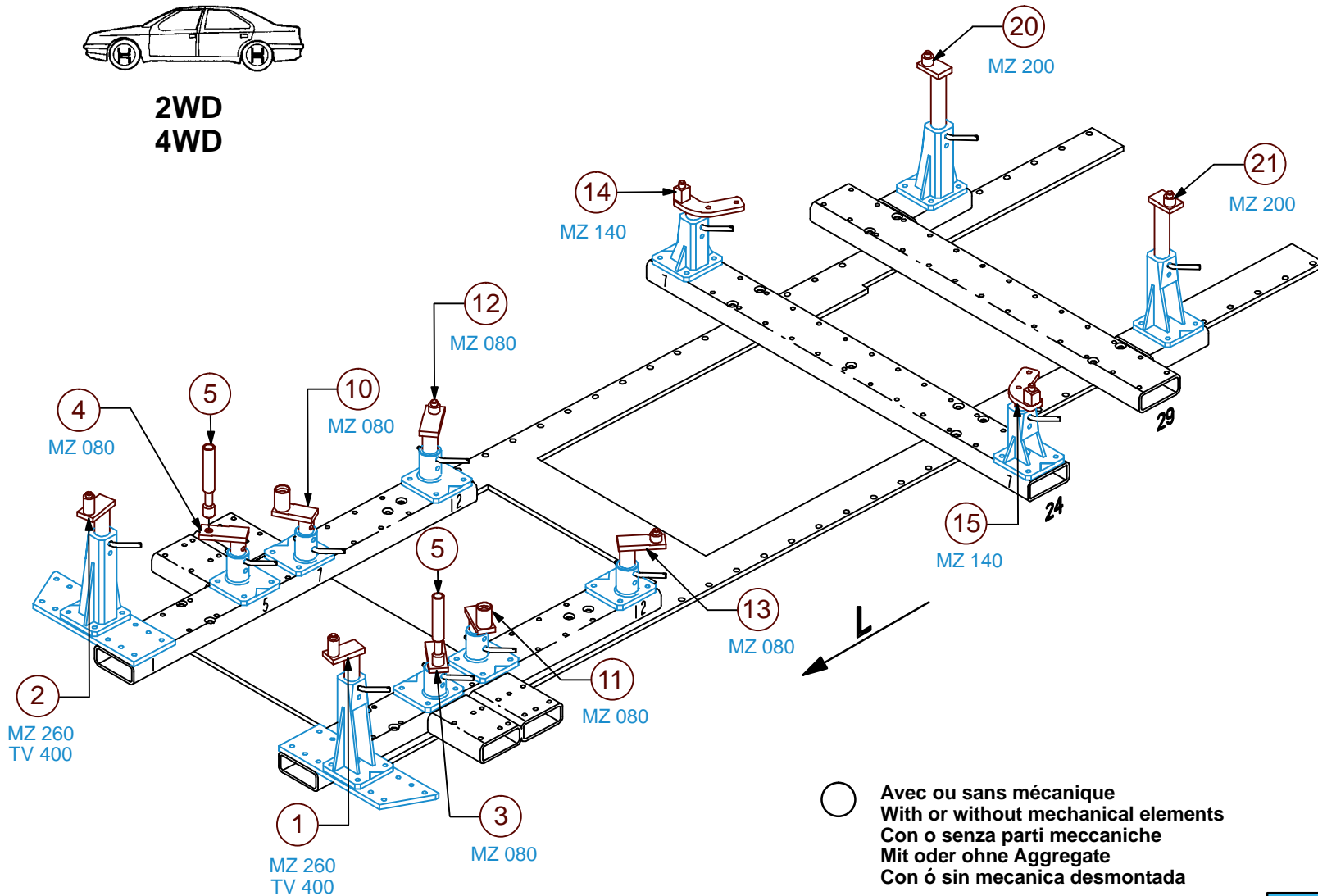

○ Avec ou sans mécanique  
With or without mechanical elements  
Con o senza parti meccaniche  
Mit oder ohne Aggregate  
Con ó sin mecanica desmontada

**TOYOTA**

**2077.300**

46 Kg 22.09.2008 434-D-84B

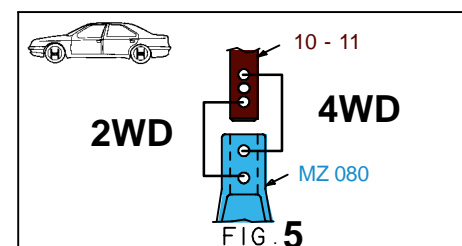
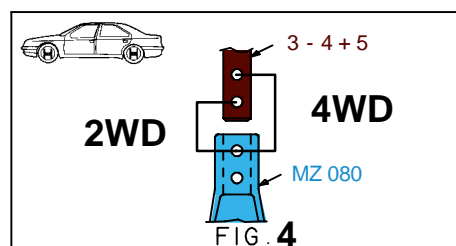
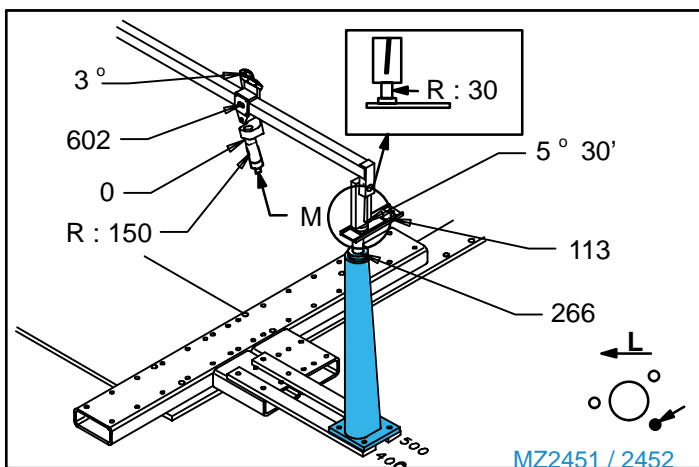
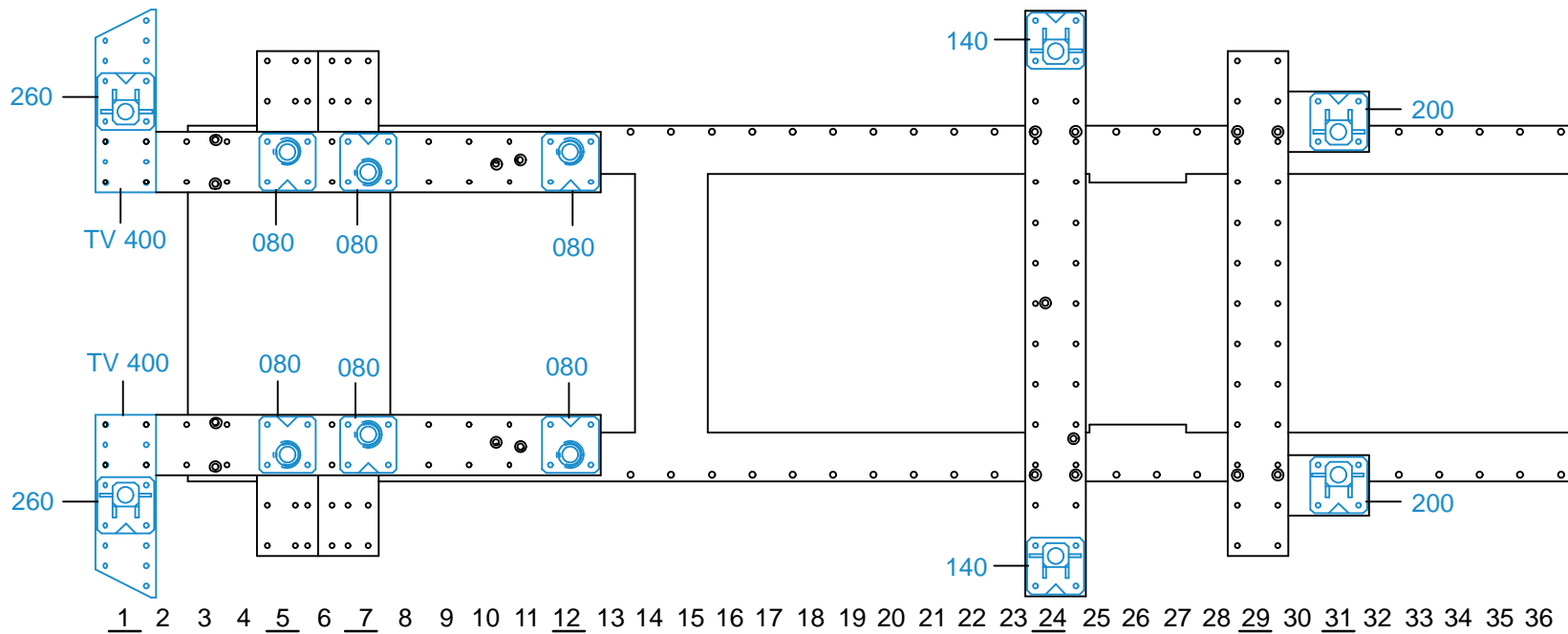

2077.300-RVA3-1 | 01

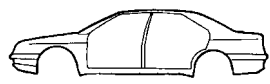

4WD

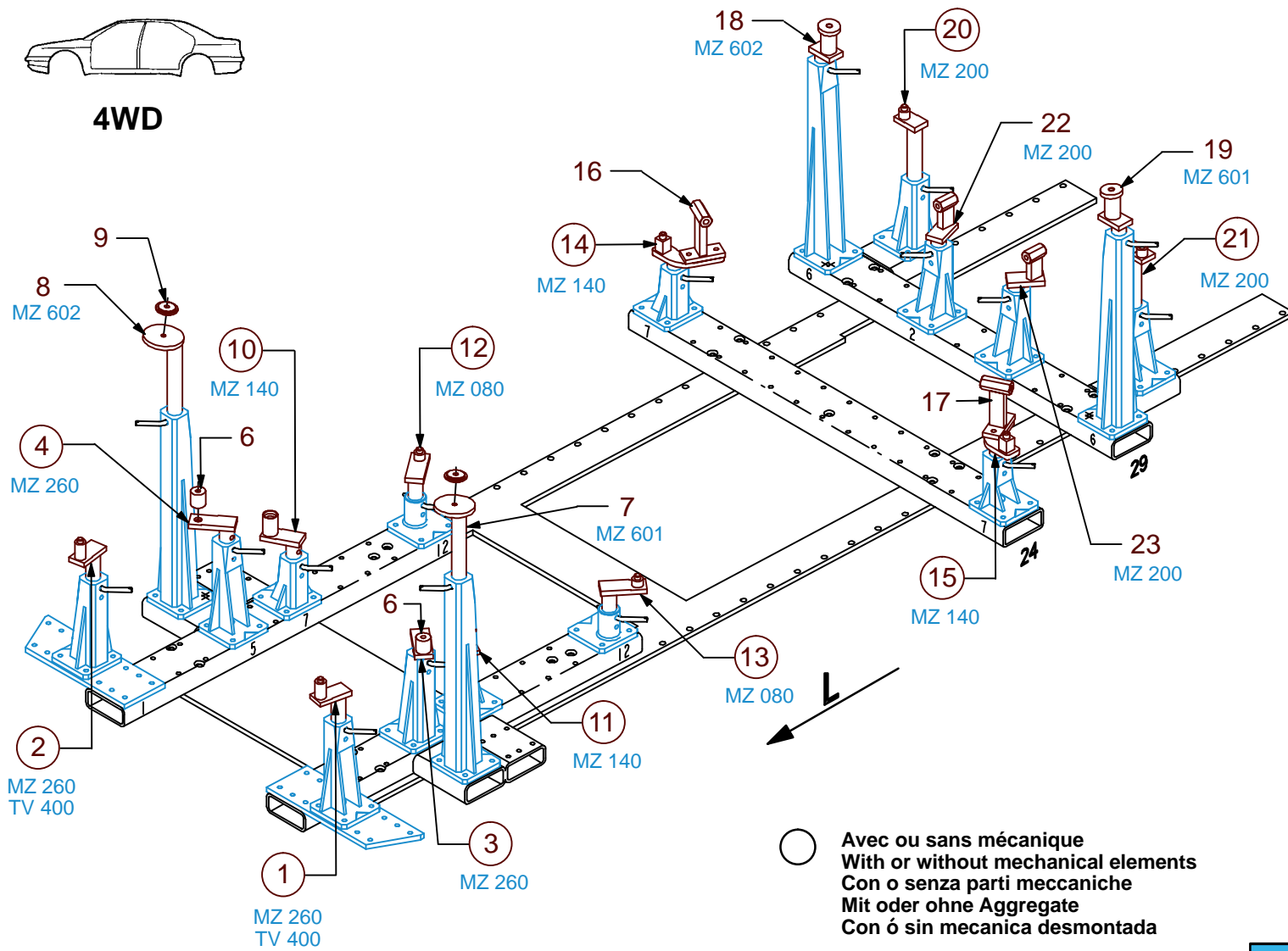

○ Avec ou sans mécanique  
With or without mechanical elements  
Con o senza parti meccaniche  
Mit oder ohne Aggregate  
Con ó sin mecanica desmontada

TOYOTA

**2077.300**

46 Kg    22.09.2008    434-D-84C

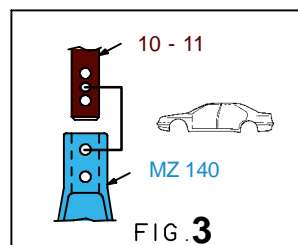
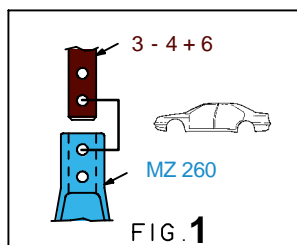
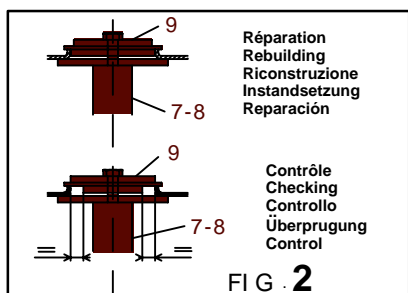
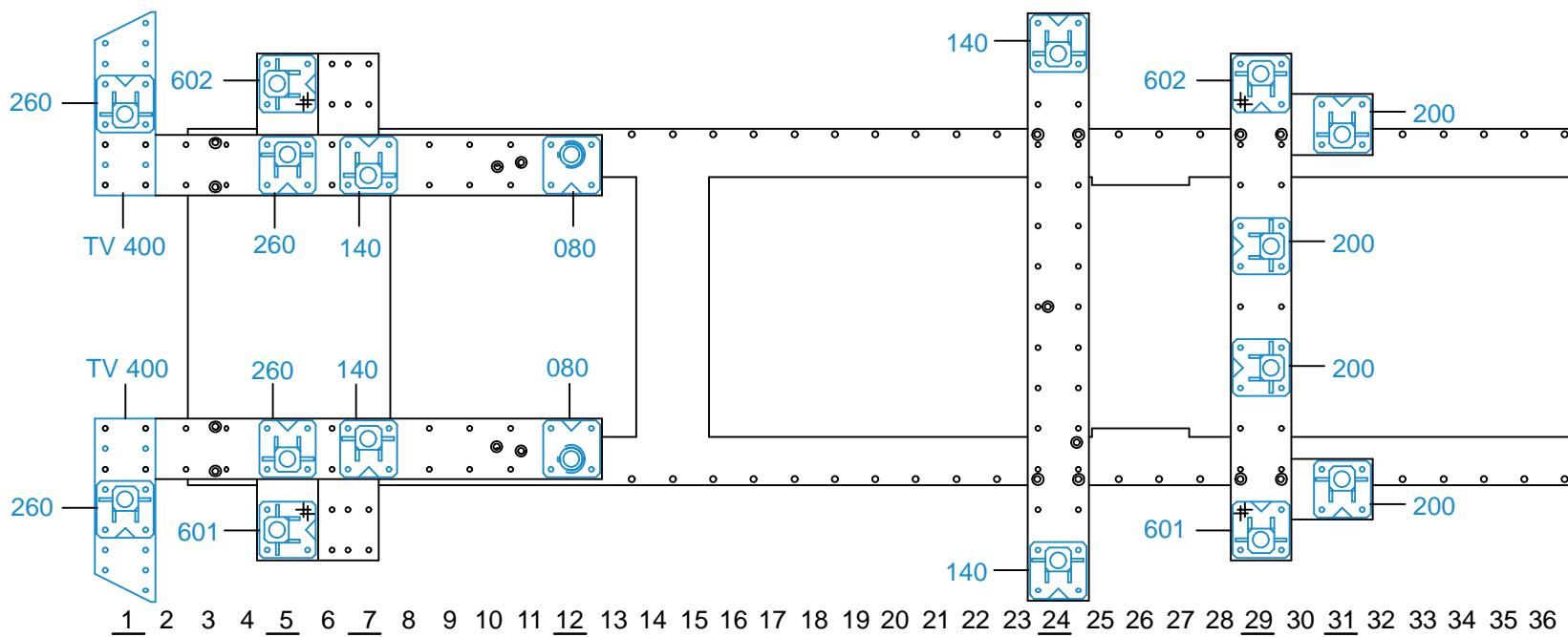

2077.300-RA3-2 | 01