

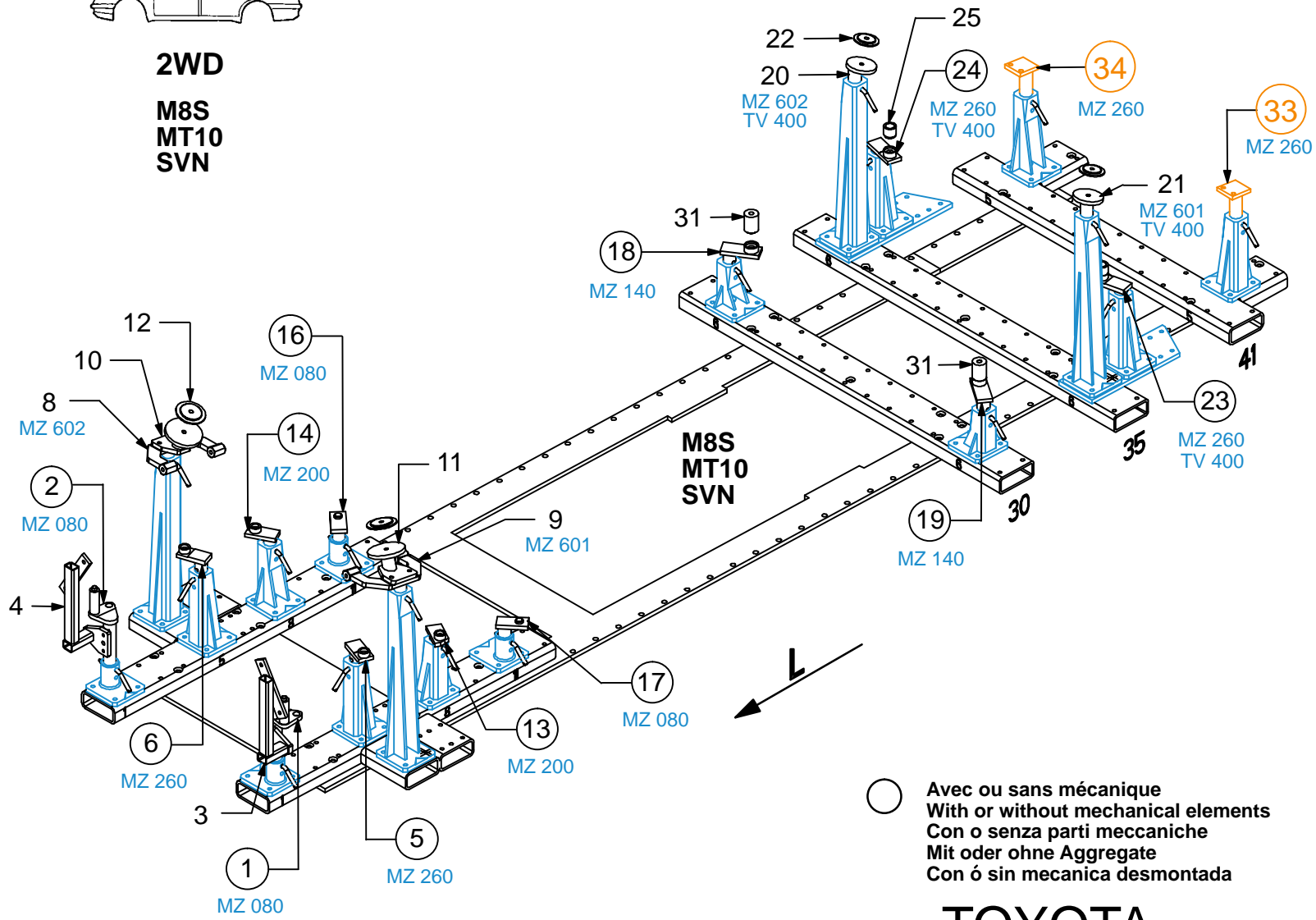

**2WD**  
**M8S**  
**MT10**  
**SVN**



○ Avec ou sans mécanique  
With or without mechanical elements  
Con o senza parti meccaniche  
Mit oder ohne Aggregate  
Con ó sin mecanica desmontada

**TOYOTA**

REP.	REFERENCE	PDS	NB	MZ
32	2076.7032	0,8	2	
33	2076.7033	2,1	1	260
34	2076.7034	2,1	1	260

M 14x1,50-220 2

complément au  
complementary set to  
complemento al  
zusatz zu **2076.300**

**2076.309**

7 Kg 20.03.2006 434-D-83E

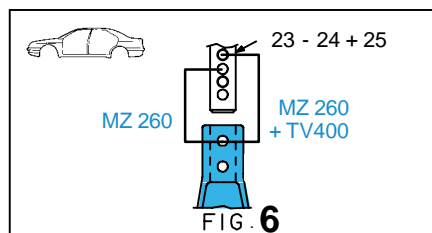
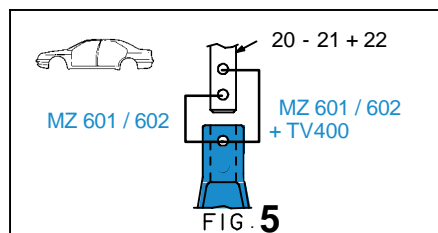
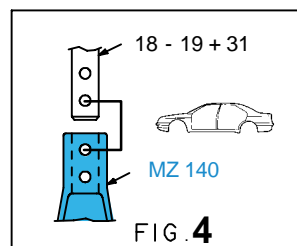
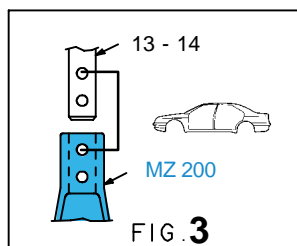
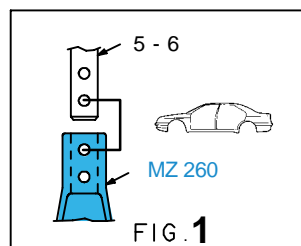
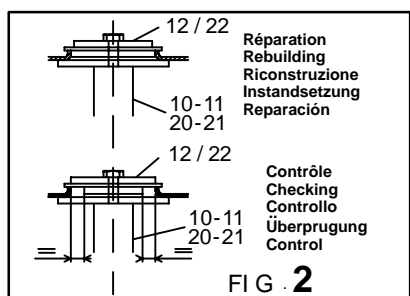
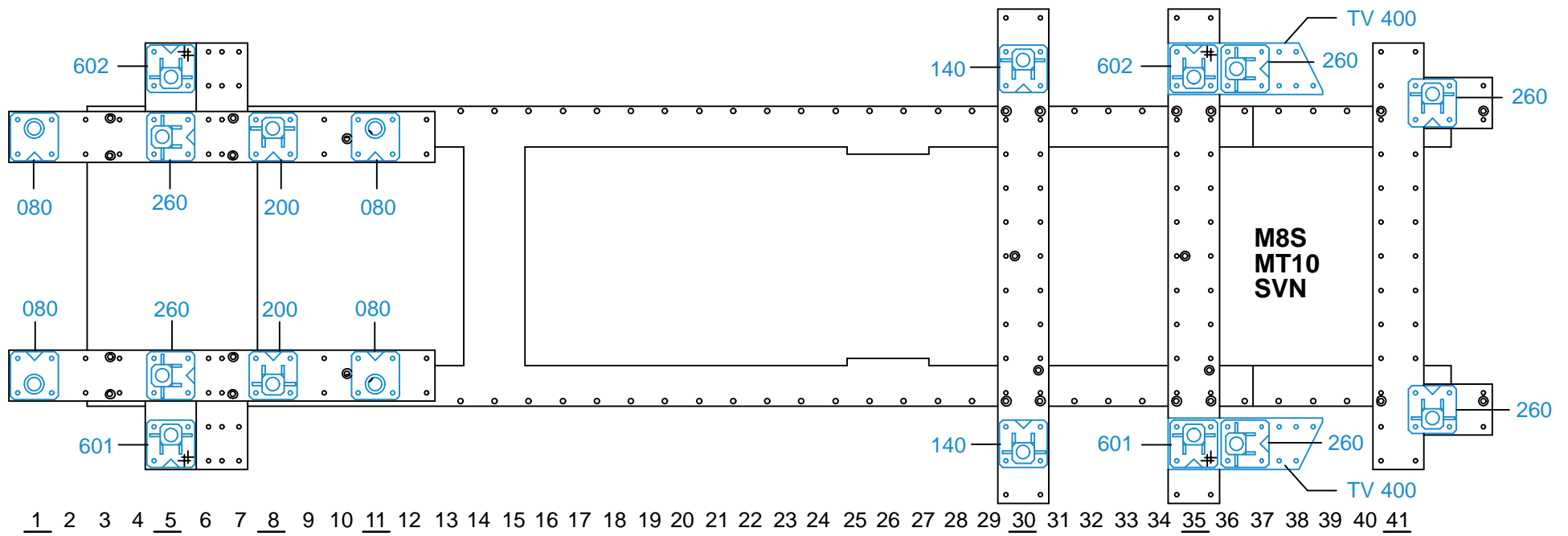

2076.309-RVA3-1 00

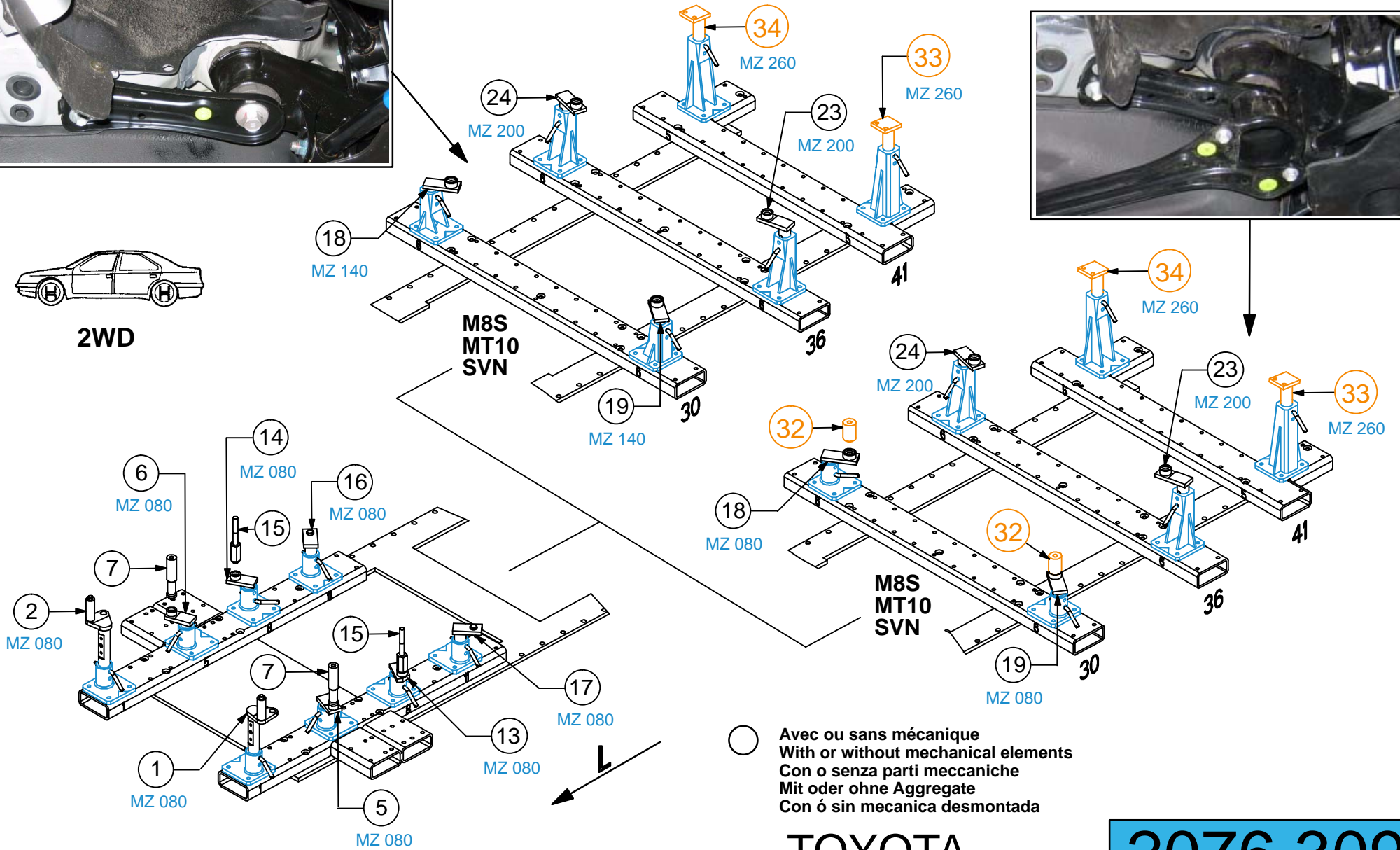
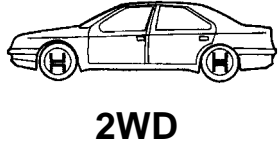

○ Avec ou sans mécanique  
With or without mechanical elements  
Con o senza parti meccaniche  
Mit oder ohne Aggregate  
Con ó sin mecanica desmontada

**TOYOTA**

**2076.309**  
7 Kg | 20.03.2006 | 434-D-83F

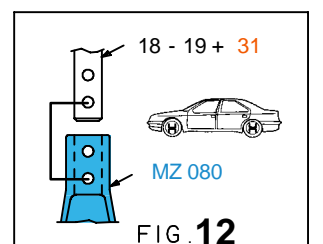
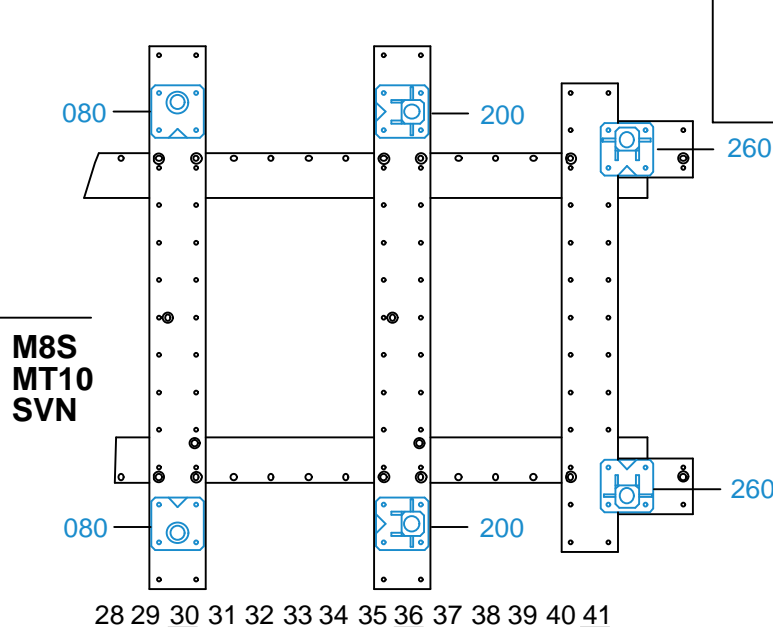
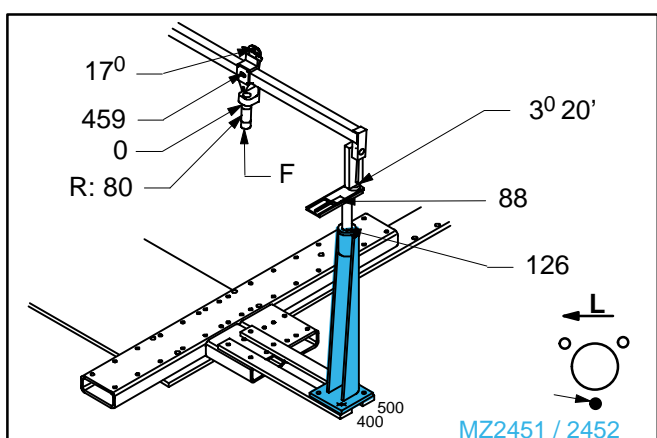
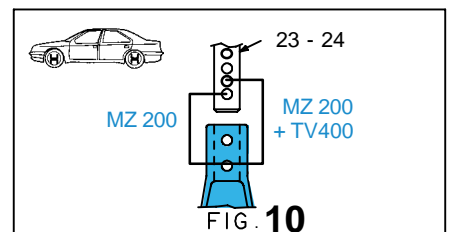
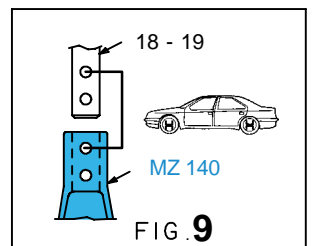
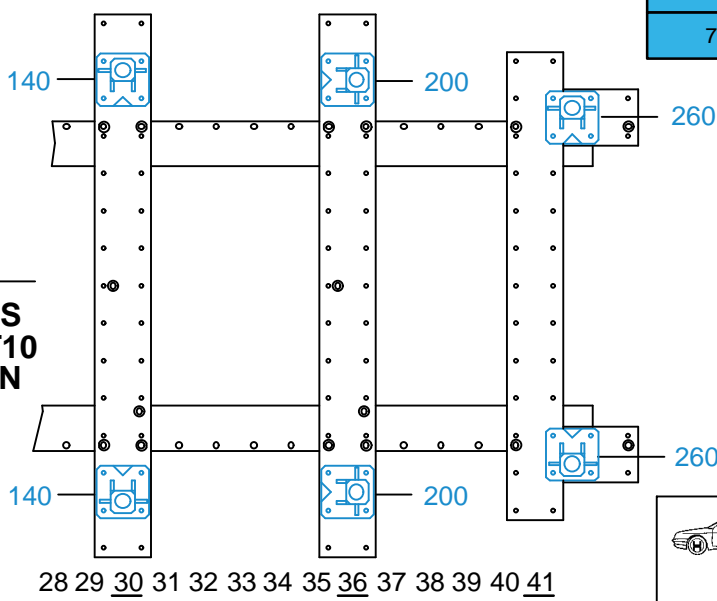
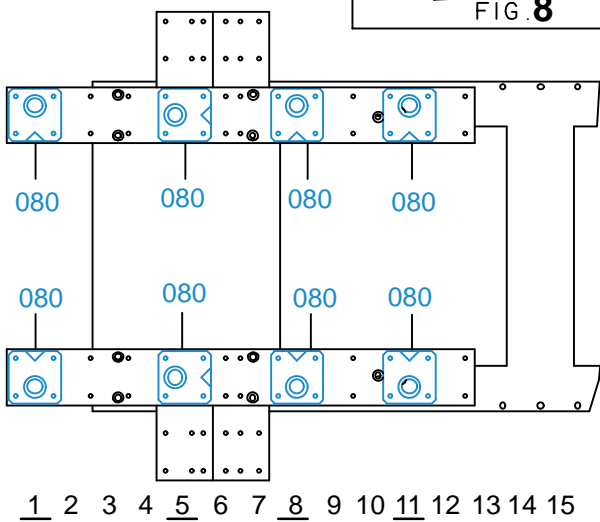
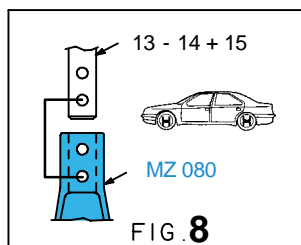
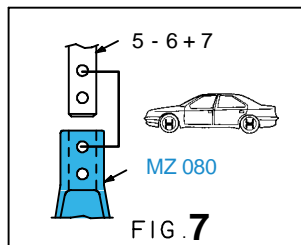

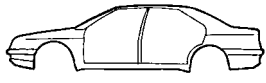

**4WD**  
**M8S**  
**MT10**  
**SVN**

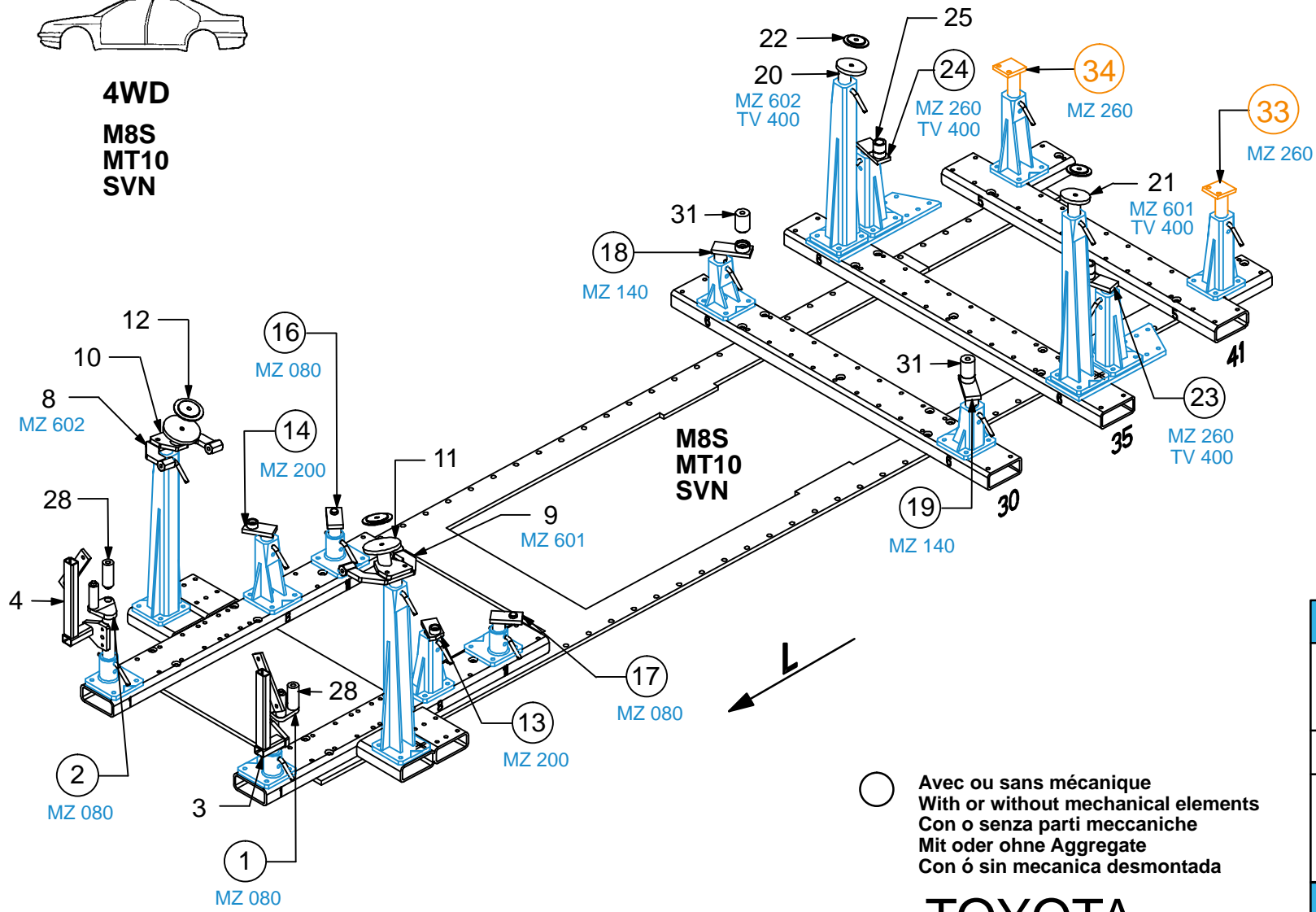

○ Avec ou sans mécanique  
With or without mechanical elements  
Con o senza parti meccaniche  
Mit oder ohne Aggregate  
Con ó sin mecanica desmontada

REP.	REFERENCE	PDS	NB	MZ
32	2076.7032	0,8	2	
33	2076.7033	2,1	1	260
34	2076.7034	2,1	1	260

M 14x1,50-220 2

complément au  
complementary set to  
complemento al  
zusatz zu **2076.300**

**2076.309**

7 Kg 20.03.2006 434-D-83G

**TOYOTA**

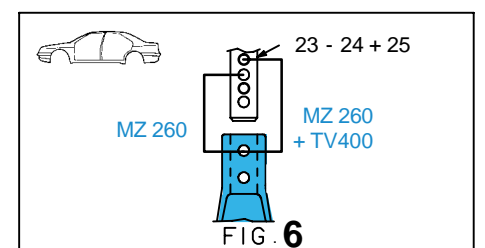
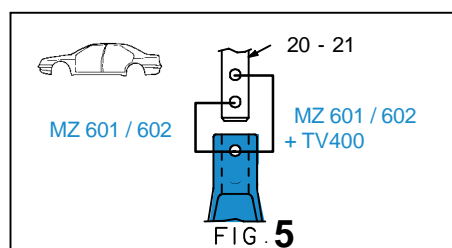
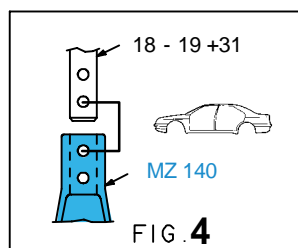
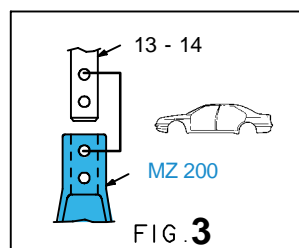
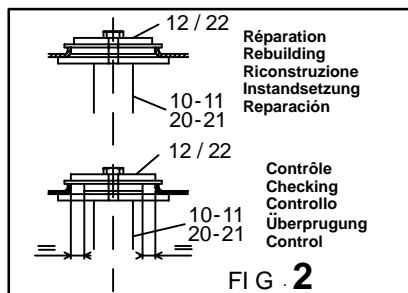
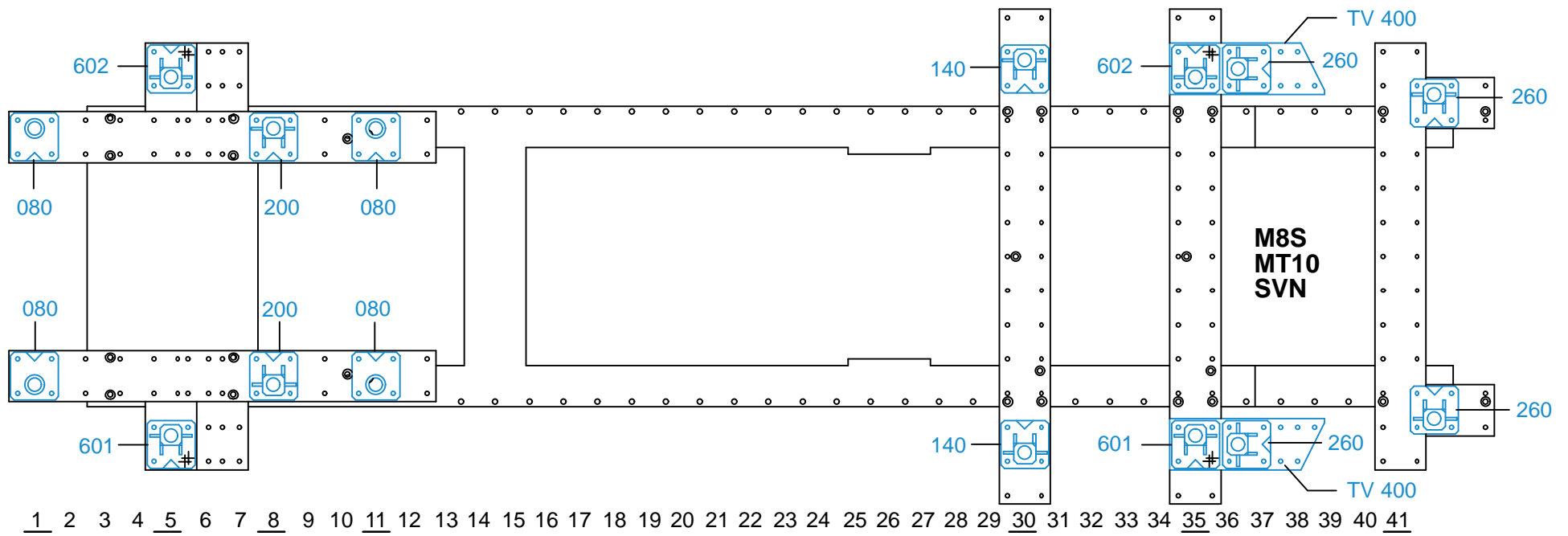

2076.309-RVA3-2 00

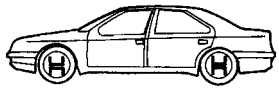

**4WD**  
**M8S**  
**MT10**  
**SVN**

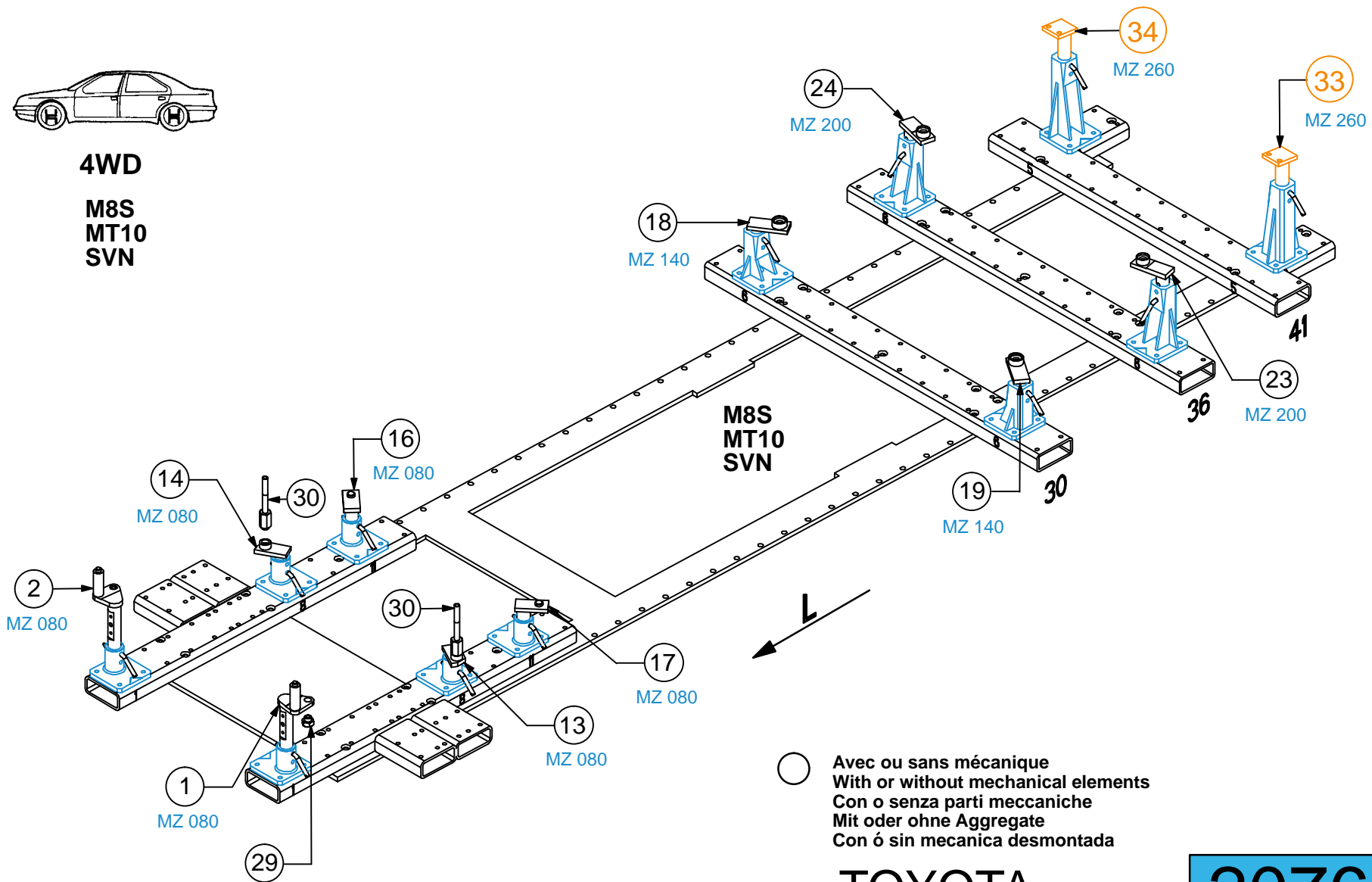

**TOYOTA**

**2076.309**

7 Kg    20.03.2006    434-D-83H

