

2WD

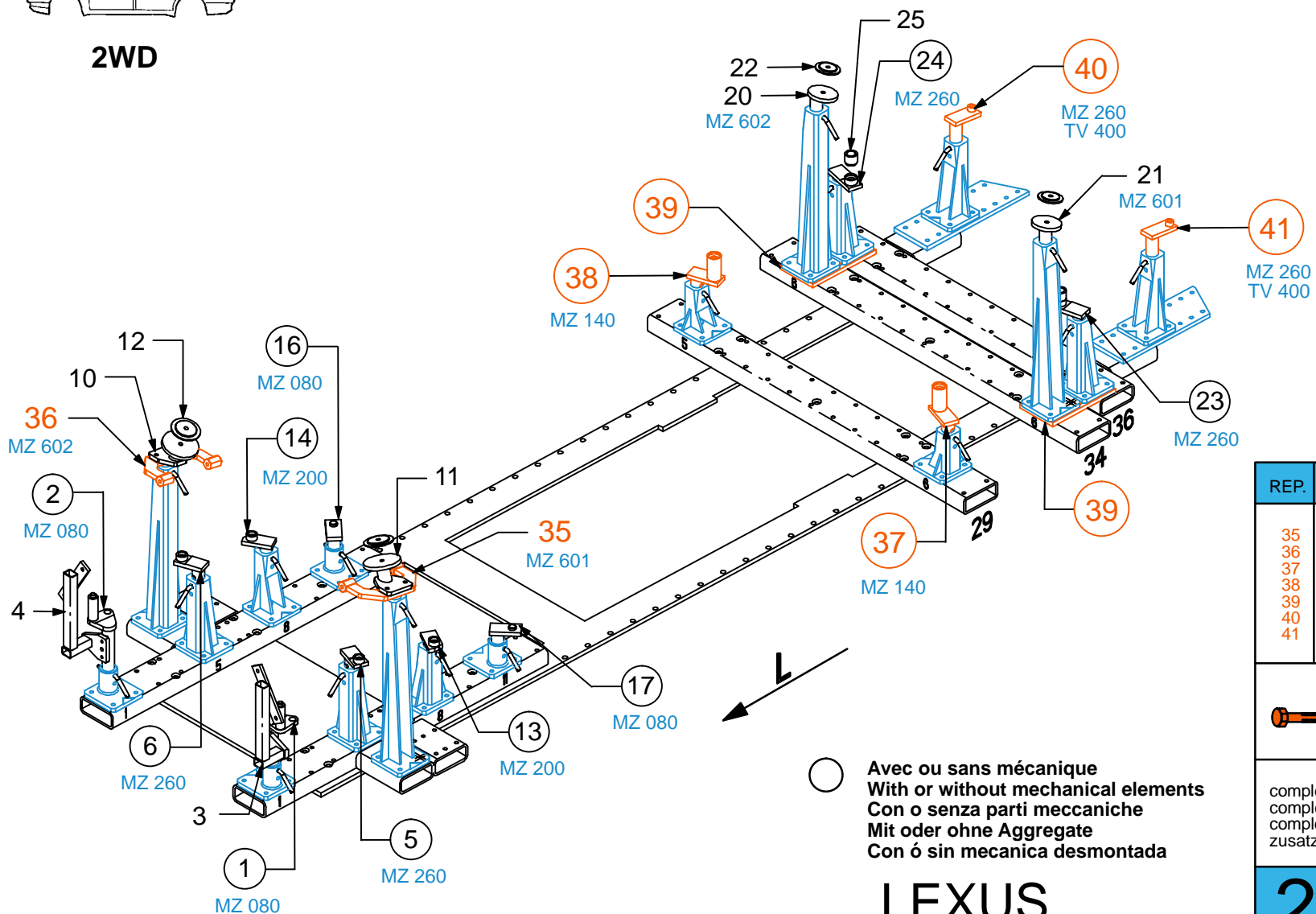

○ Avec ou sans mécanique
 With or without mechanical elements
 Con o senza parti meccaniche
 Mit oder ohne Aggregate
 Con ó sin mecanica desmontada

LEXUS

REP.	REFERENCE	PDS	NB	MZ
35	2076.7035	3,1	1	601
36	2076.7036	3,1	1	602
37	2076.7037	2,4	1	140/080
38	2076.7038	2,4	1	140/080
39	2076.7039	4,7	2	
40	2076.7040	2,0	1	260
41	2076.7041	2,0	1	260

- CHc TB 12-25
- M 12-25
- M 12x1,25-60
- M 14x1,50-120
- M 14x1,50-220

complément au
 complementary set to
 complemento al
 zusatz zu

2076.300

2076.308

26 Kg 08.01.2007 434-D-83K

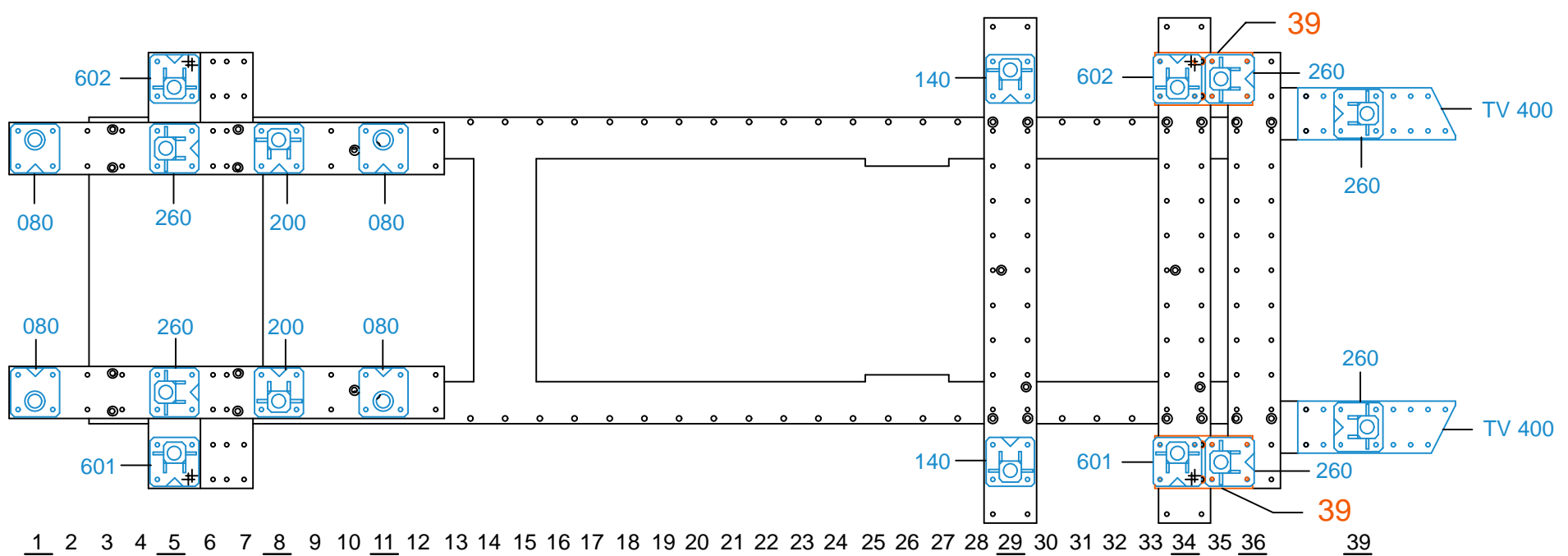

1 2 3 4 5 6 7 8 9 10 11 12 13 14 15 16 17 18 19 20 21 22 23 24 25 26 27 28 29 30 31 32 33 34 35 36 39

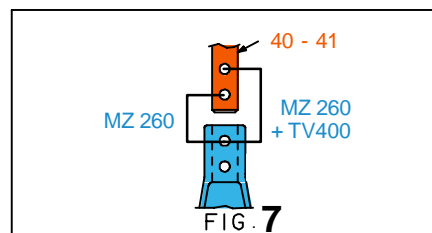
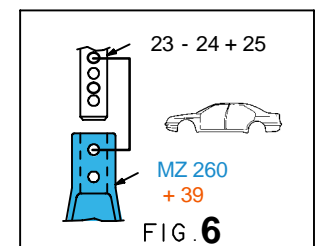
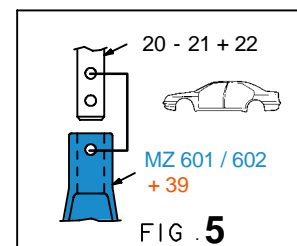
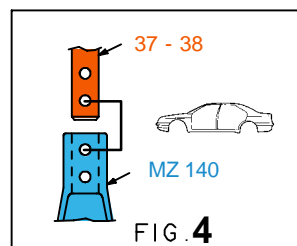
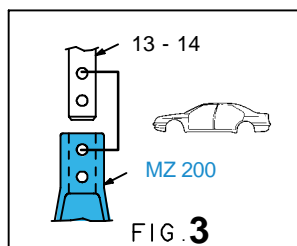
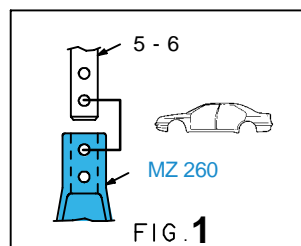
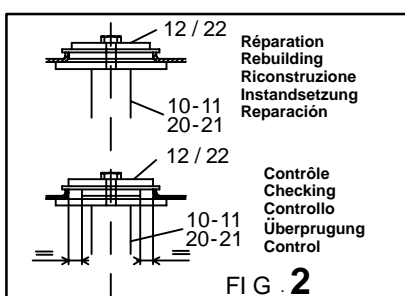

2076.308-RVA3-1 00

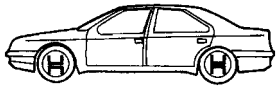

2WD

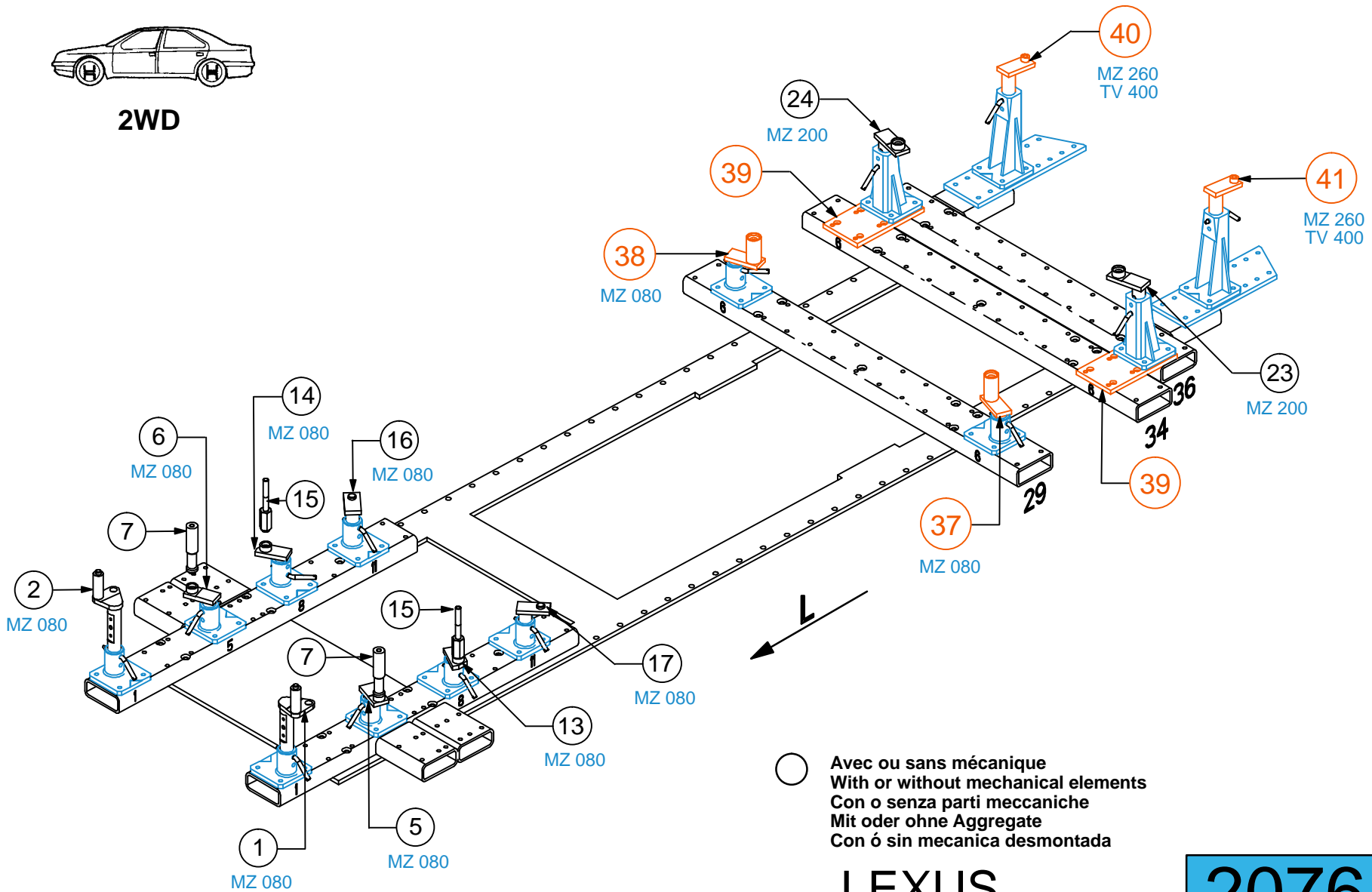

LEXUS

2076.308

26 Kg | 08.01.2007 | 434-D-83L

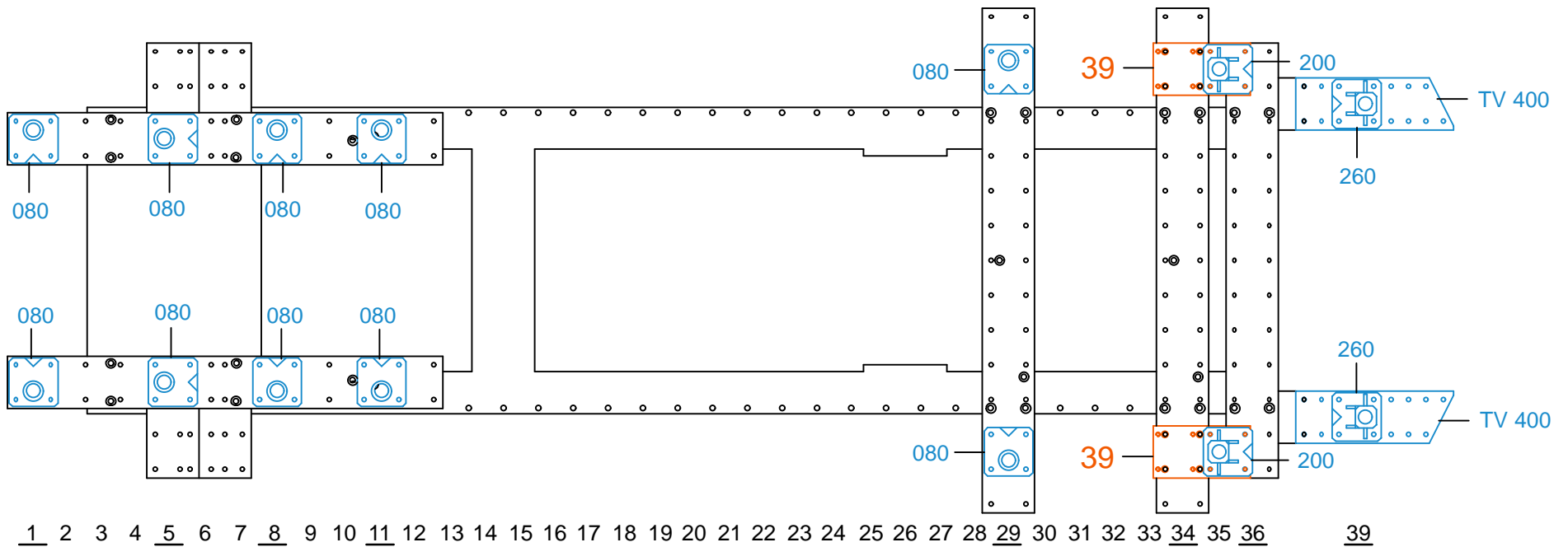

1 2 3 4 5 6 7 8 9 10 11 12 13 14 15 16 17 18 19 20 21 22 23 24 25 26 27 28 29 30 31 32 33 34 35 36 39

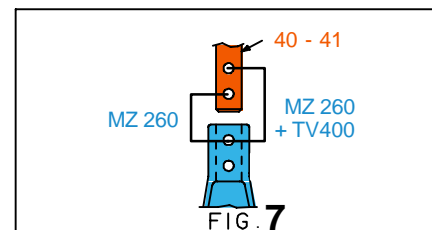
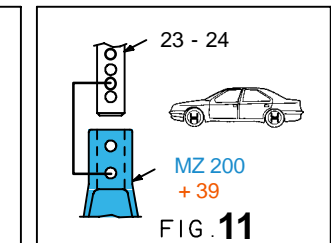
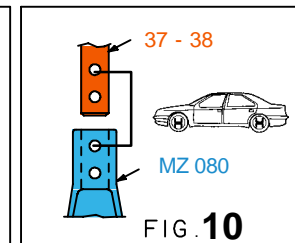
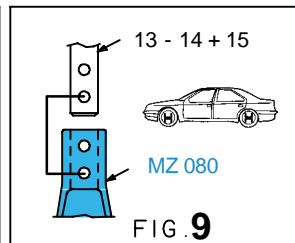
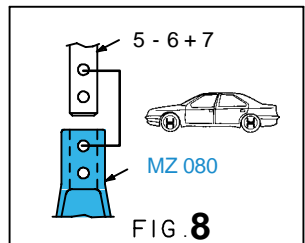
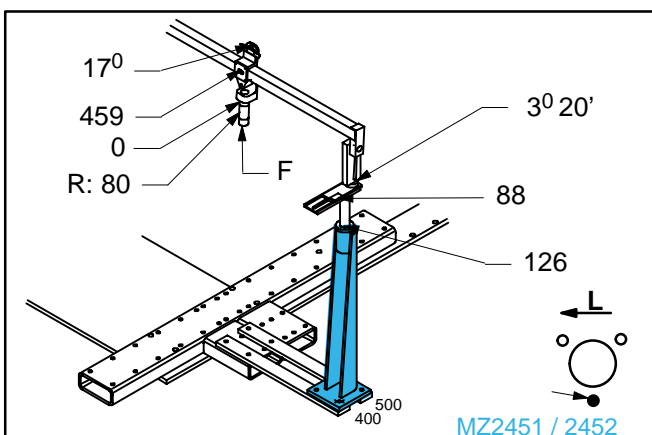

2076.308-RVA3-1 | 00



4WD

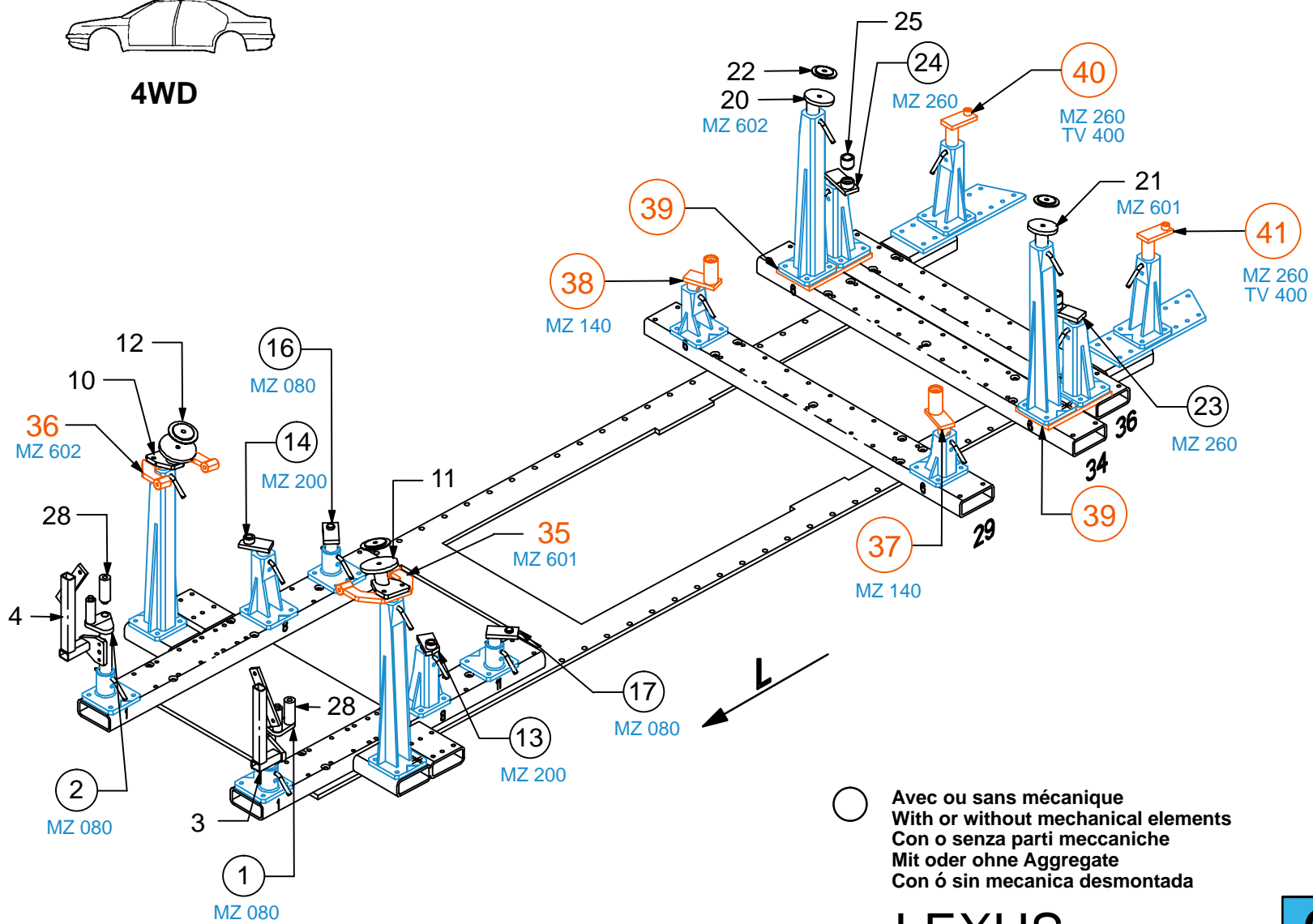

LEXUS

2076.308

26 Kg 08.01.2007 434-D-83M

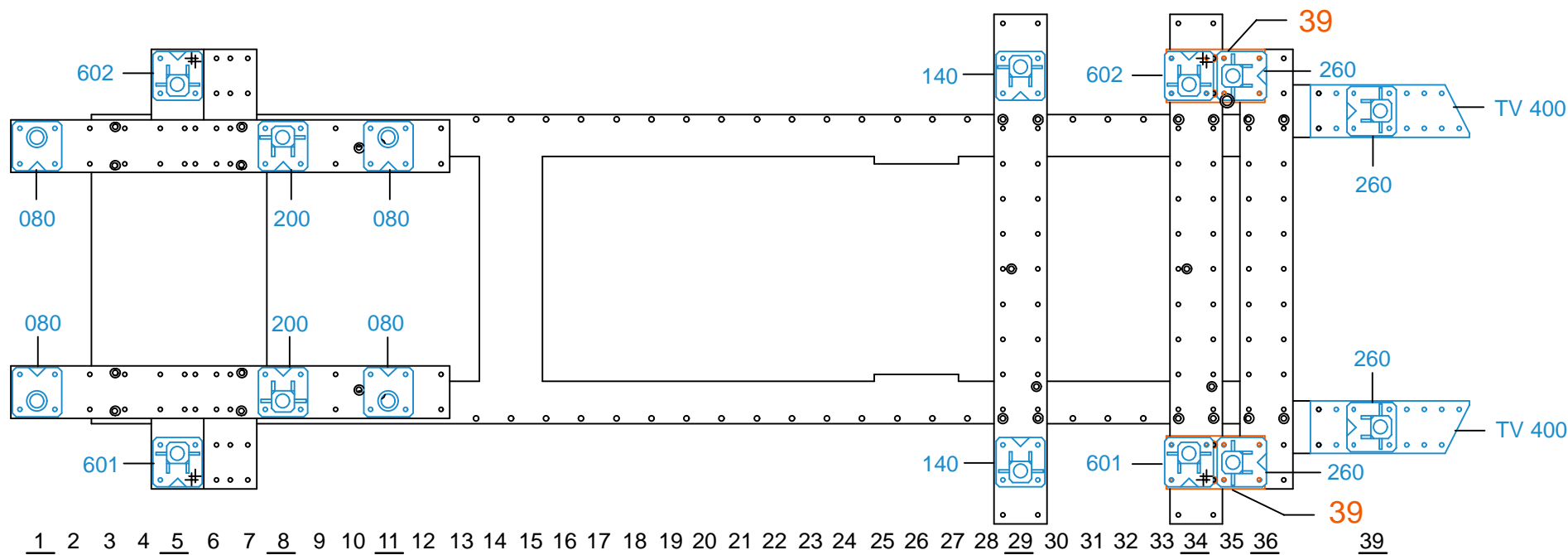

1 2 3 4 5 6 7 8 9 10 11 12 13 14 15 16 17 18 19 20 21 22 23 24 25 26 27 28 29 30 31 32 33 34 35 36 39

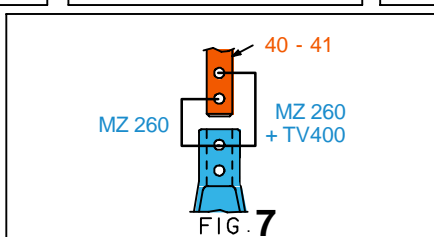
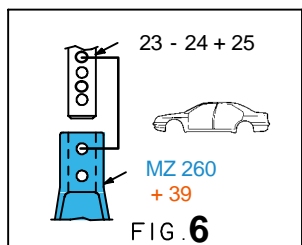
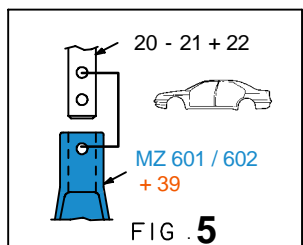
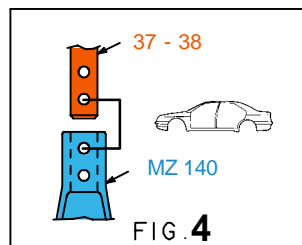
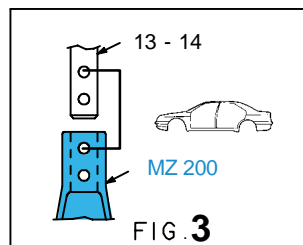
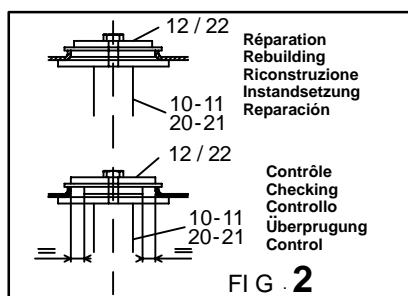

2076.308-RVA3-2 00



4WD

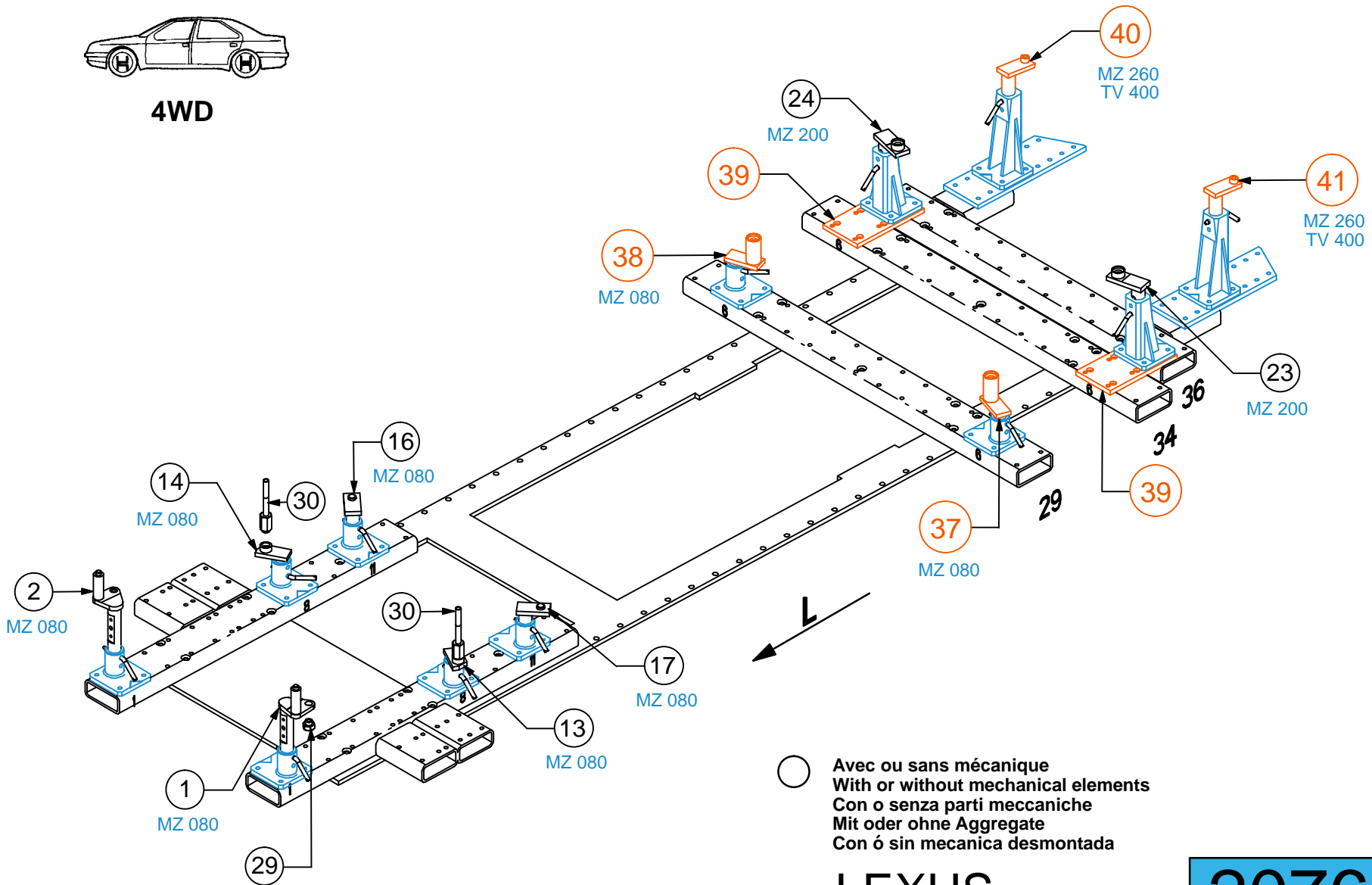

LEXUS

2076.308

26 Kg | 08.01.2007 | 434-D-83N

