

2WD

M8S
MT10
SVN

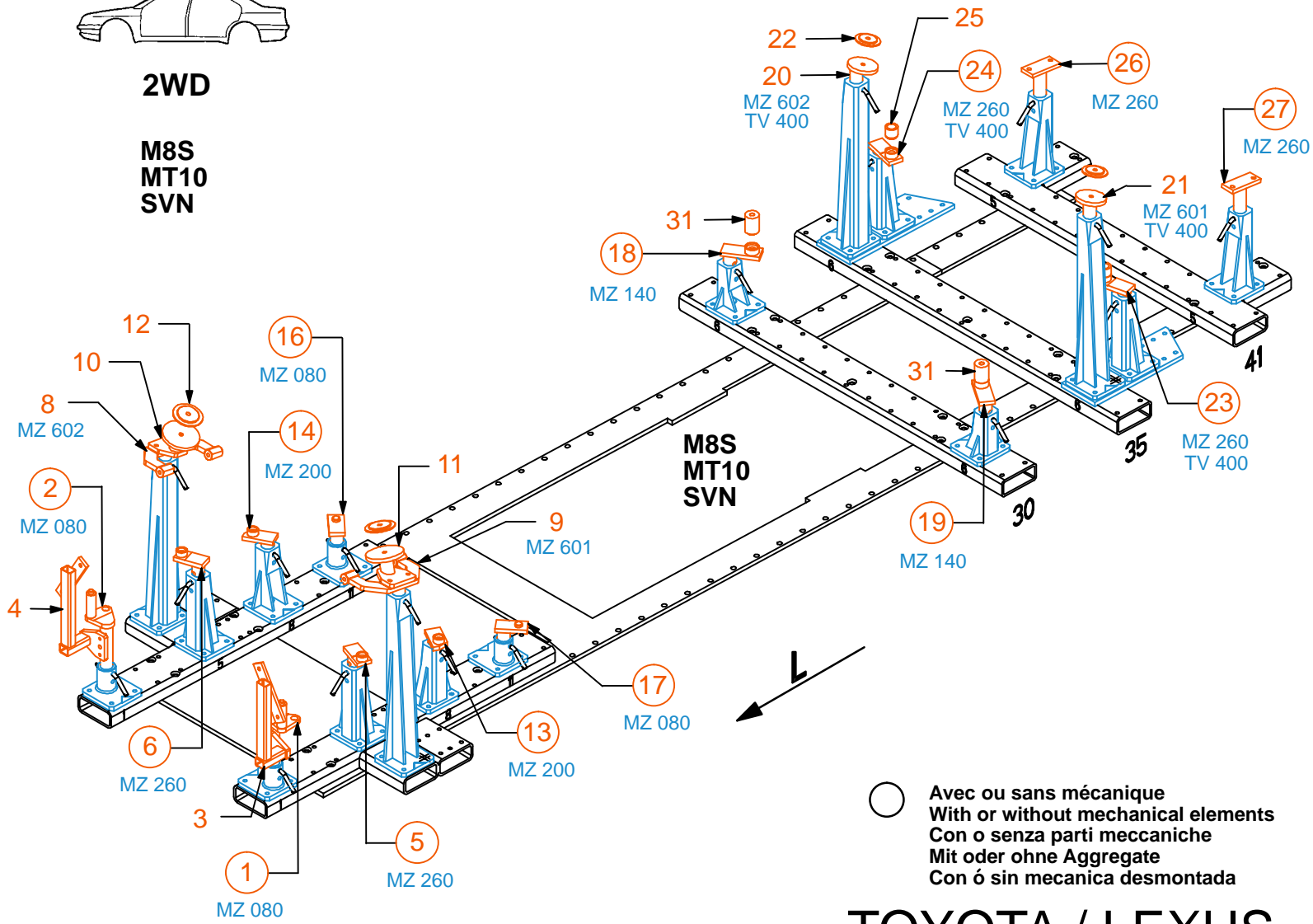

○ Avec ou sans mécanique
 With or without mechanical elements
 Con o senza parti meccaniche
 Mit oder ohne Aggregate
 Con ó sin mecanica desmontada

TOYOTA / LEXUS

REP.	REFERENCE	PDS	NB	MZ
1	2076.7001	3,2	1	080
2	2076.7002	3,2	1	080
3	2076.7003	2,5	1	
4	2076.7004	2,5	1	
5	2076.7005	1,6	1	260/080
6	2076.7006	1,6	1	260/080
7	2076.7007	1,0	2	
8	2076.7008	3,2	1	602
9	2076.7009	3,2	1	601
10	2076.7010	2,2	1	
11	2076.7011	2,2	1	
12	2076.7012	0,5	2	
13	2076.7013	1,3	1	200/080
14	2076.7014	1,3	1	200/080
15	2076.7015	0,6	2	
16	2076.7016	1,5	1	080
17	2076.7017	1,5	1	080
18	2076.7018	1,8	1	140
19	2076.7019	1,8	1	140
20	2076.7020	1,8	1	602
21	2076.7021	1,8	1	601
22	2076.7022	0,3	2	
23	2076.7023	1,6	1	260/200
24	2076.7024	1,6	1	260/200
25	2076.7025	0,2	2	
26	2076.7026	2,1	1	260
27	2076.7027	2,1	1	260
28	2076.7028	0,5	2	
29	2076.7029	0,1	2	
30	2076.7030	0,5	2	
31	2076.7031	0,7	2	

M 12-25	10
M 16-40	2
M 10x1,25-30	4
M 12x1,25-40	4
M 14x1,50-40	2
M 14x1,50-50	4
M 14x1,50-110	2
M 14x1,50-120	2
M 14x1,50-130	2
M 14x1,50-150	2
M 16x1,50-70	2
LU 14	2

2076.300

56 Kg	20.03.2006	434-D-83A
-------	------------	-----------

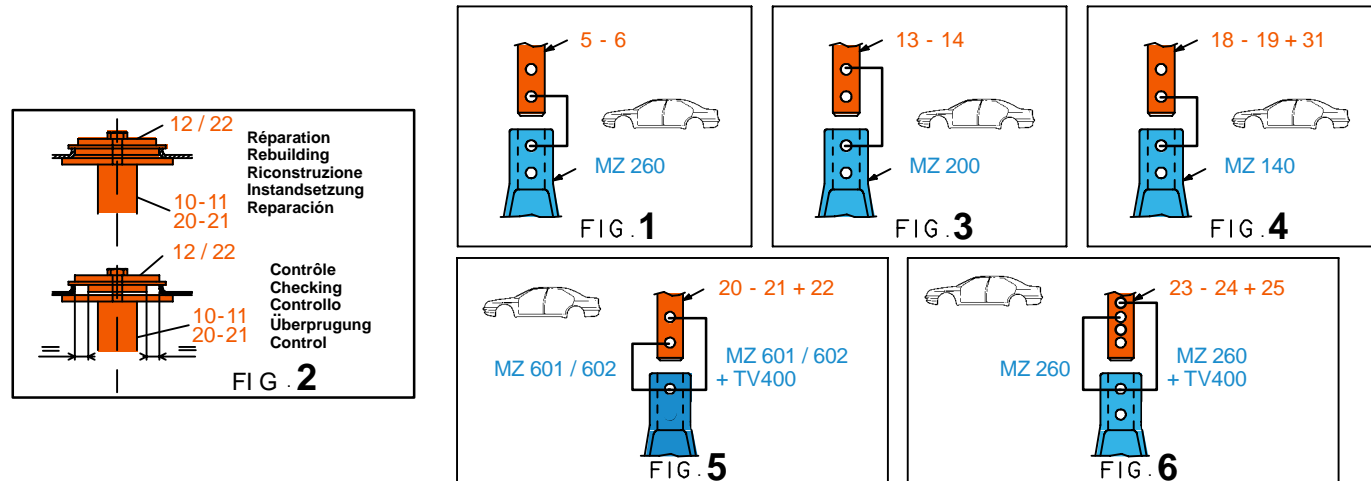
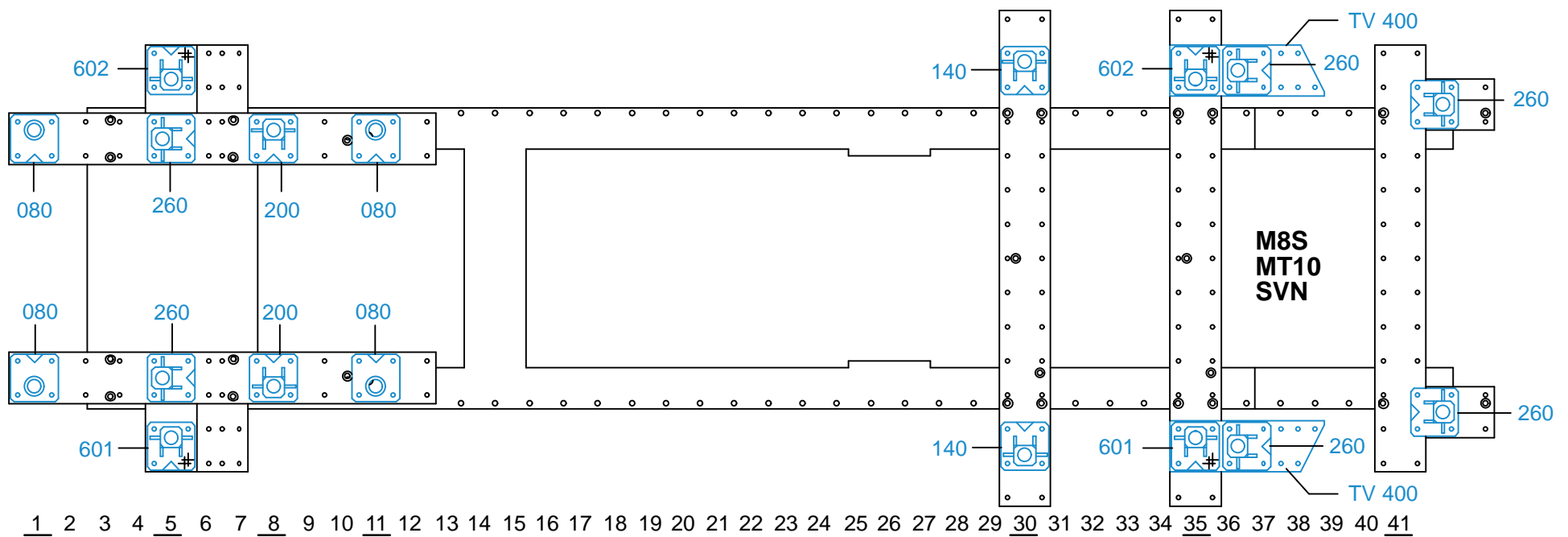

2076.300-RVA3-1 00

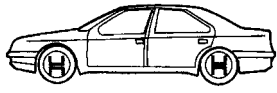

2WD

M8S
MT10
SVN

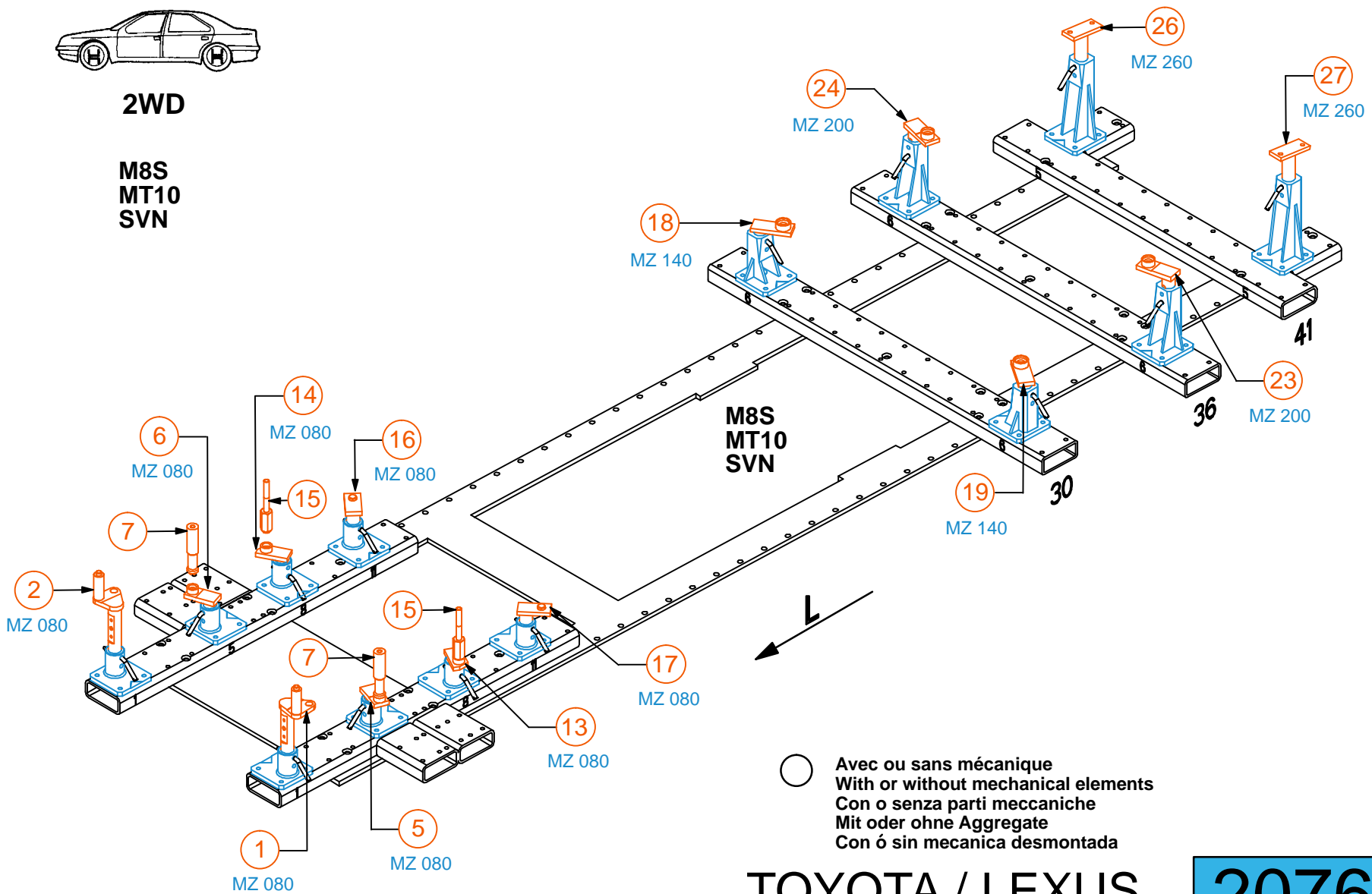

○ Avec ou sans mécanique
With or without mechanical elements
Con o senza parti meccaniche
Mit oder ohne Aggregate
Con ó sin mecanica desmontada

TOYOTA / LEXUS

2076.300

56 Kg | 20.03.2006 | 434-D-83B

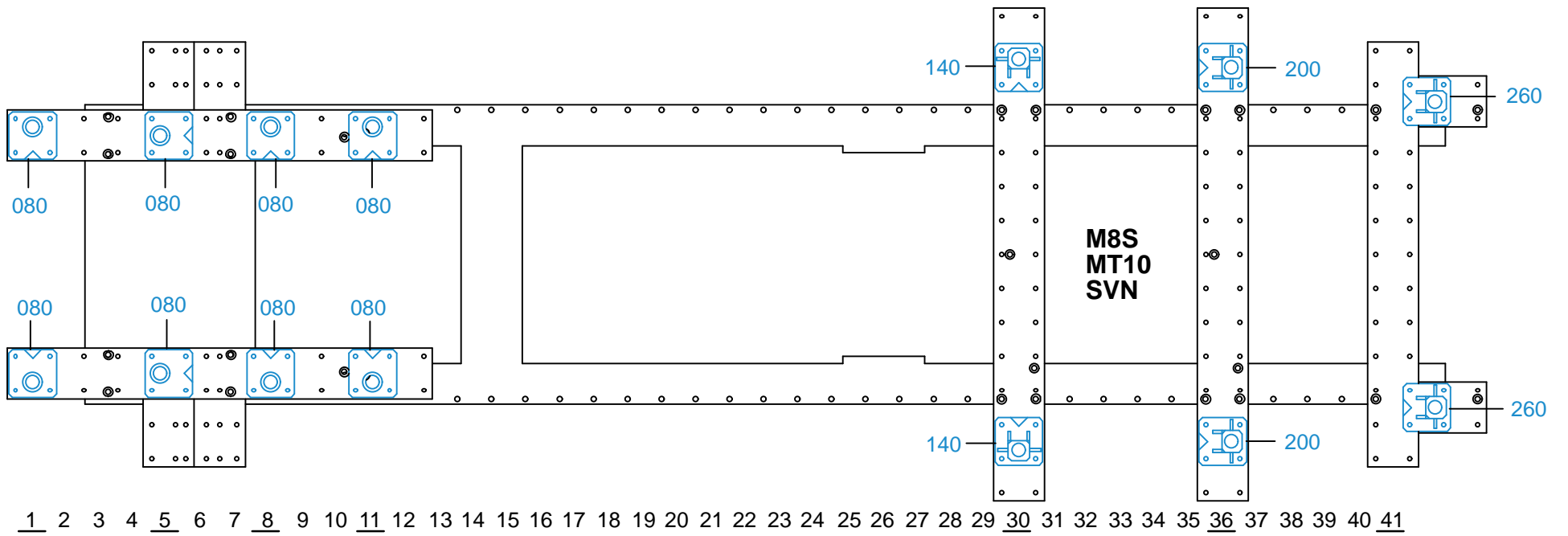

1 2 3 4 5 6 7 8 9 10 11 12 13 14 15 16 17 18 19 20 21 22 23 24 25 26 27 28 29 30 31 32 33 34 35 36 37 38 39 40 41

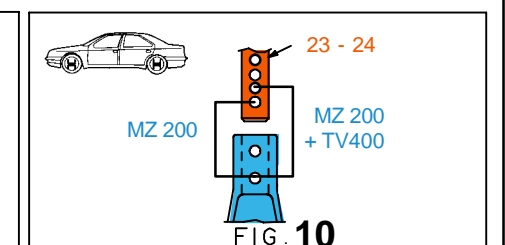
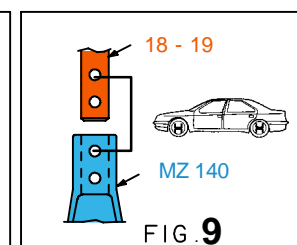
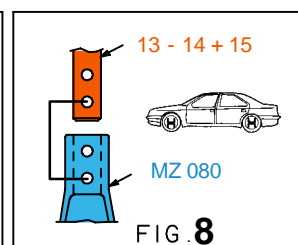
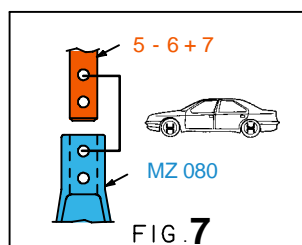
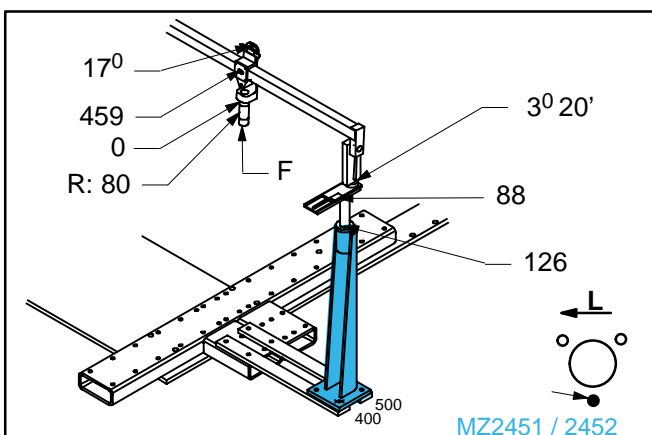

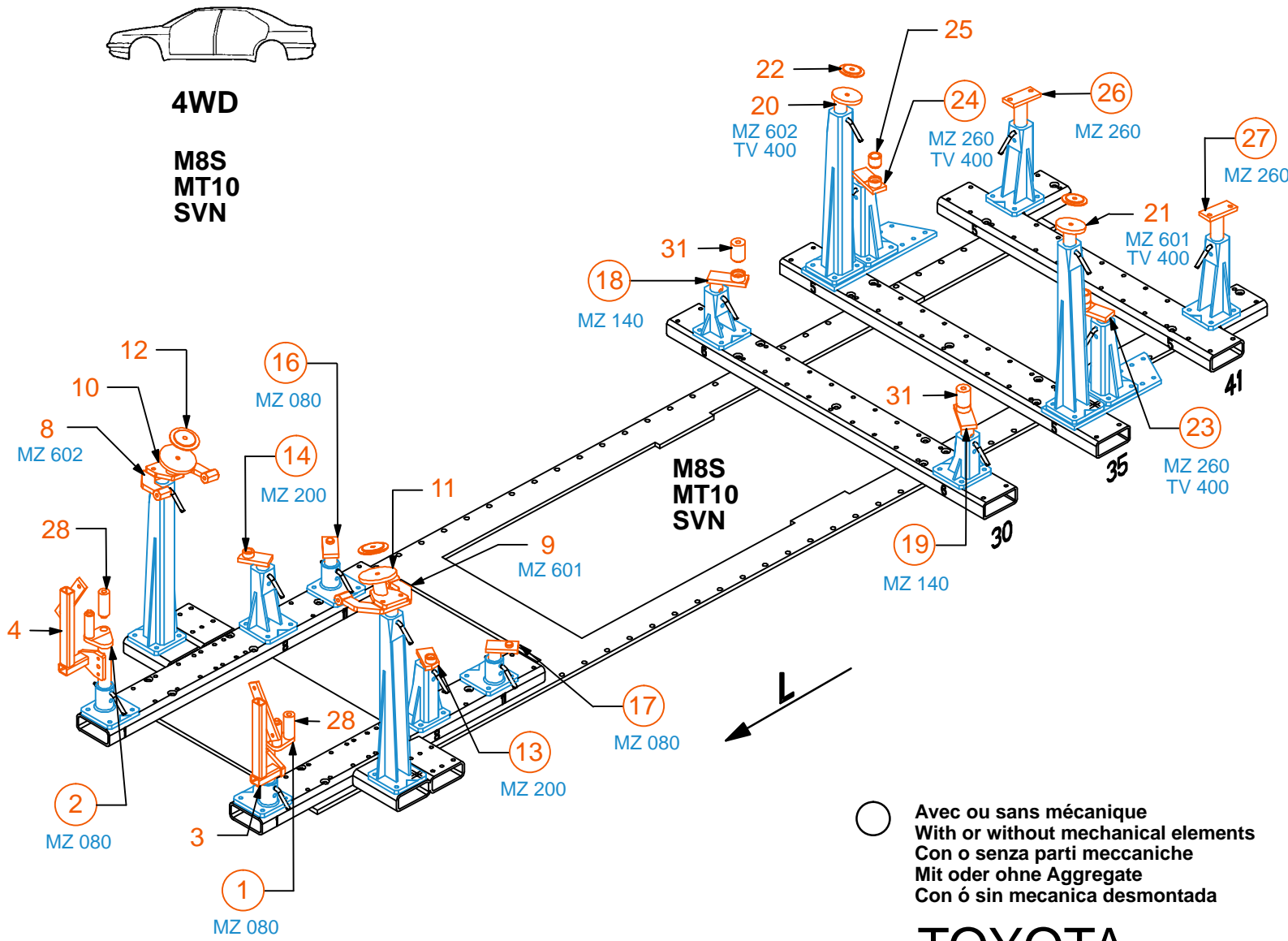

REP.	REFERENCE	PDS	NB	MZ
1	2076.7001	3,2	1	080
2	2076.7002	3,2	1	080
3	2076.7003	2,5	1	
4	2076.7004	2,5	1	
5	2076.7005	1,6	1	260/080
6	2076.7006	1,6	1	260/080
7	2076.7007	1,0	2	
8	2076.7008	3,2	1	602
9	2076.7009	3,2	1	601
10	2076.7010	2,2	1	
11	2076.7011	2,2	1	
12	2076.7012	0,5	2	
13	2076.7013	1,3	1	200/080
14	2076.7014	1,3	1	200/080
15	2076.7015	0,6	2	
16	2076.7016	1,5	1	080
17	2076.7017	1,5	1	080
18	2076.7018	1,8	1	140
19	2076.7019	1,8	1	140
20	2076.7020	1,8	1	602
21	2076.7021	1,8	1	601
22	2076.7022	0,3	2	
23	2076.7023	1,6	1	260/200
24	2076.7024	1,6	1	260/200
25	2076.7025	0,2	2	
26	2076.7026	2,1	1	260
27	2076.7027	2,1	1	260
28	2076.7028	0,5	2	
29	2076.7029	0,1	2	
30	2076.7030	0,5	2	
31	2076.7031	0,7	2	

M 12-25	10
M 16-40	2
M 10x1,25-30	4
M 12x1,25-40	4
M 14x1,50-40	2
M 14x1,50-50	4
M 14x1,50-110	2
M 14x1,50-120	2
M 14x1,50-130	2
M 14x1,50-150	2
M 16x1,50-70	2

LU 14	2
-------	---

○ Avec ou sans mécanique
With or without mechanical elements
Con o senza parti meccaniche
Mit oder ohne Aggregate
Con ó sin mecanica desmontada

TOYOTA

2076.300

56 Kg 16.09.2005 434-D-83C

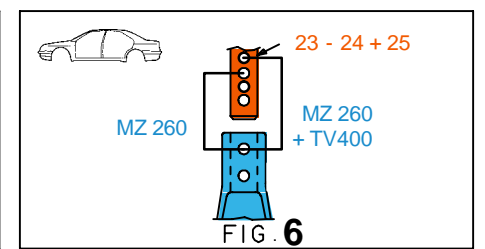
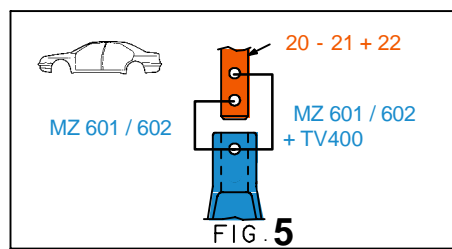
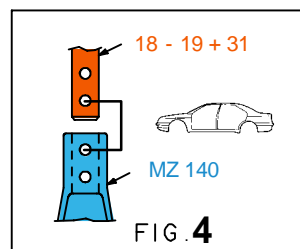
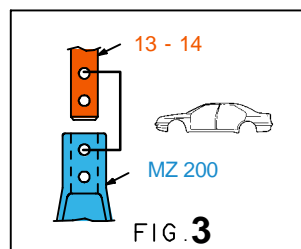
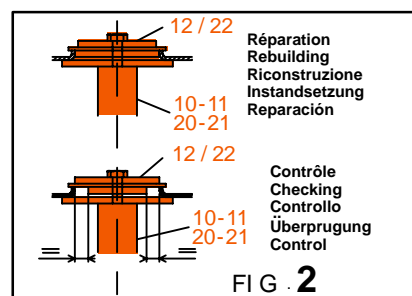
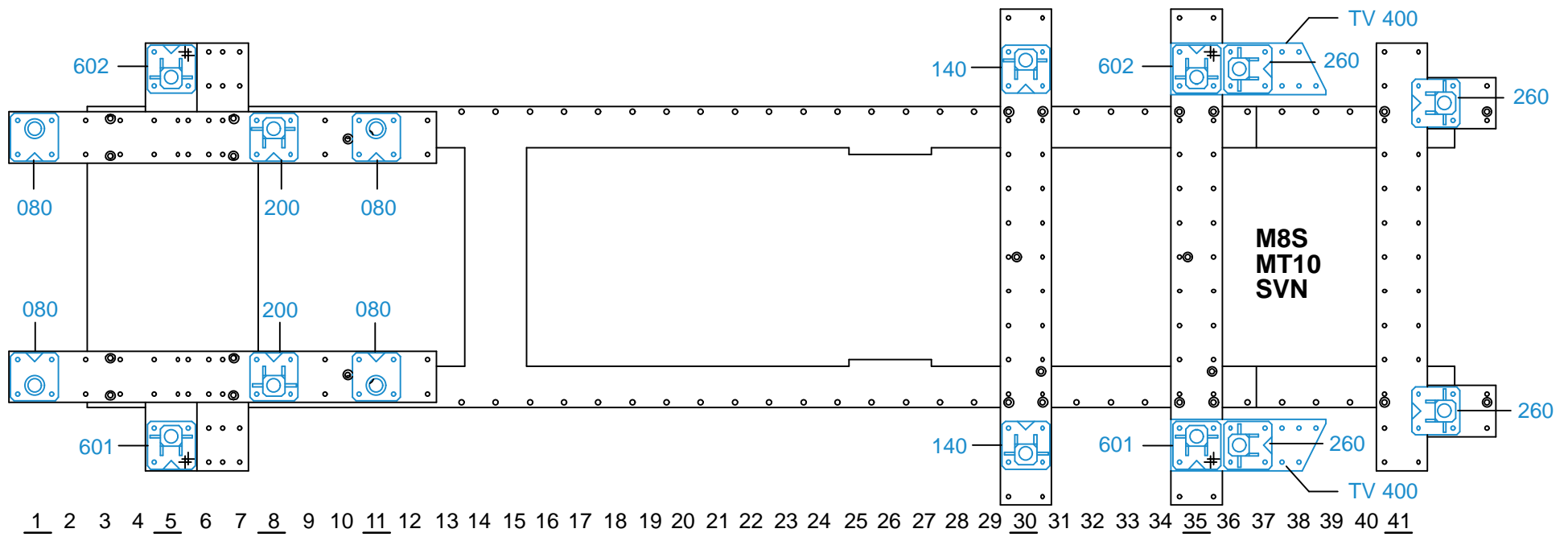

2076.300-RVA3-2 00

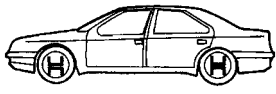

4WD

**M8S
MT10
SVN**

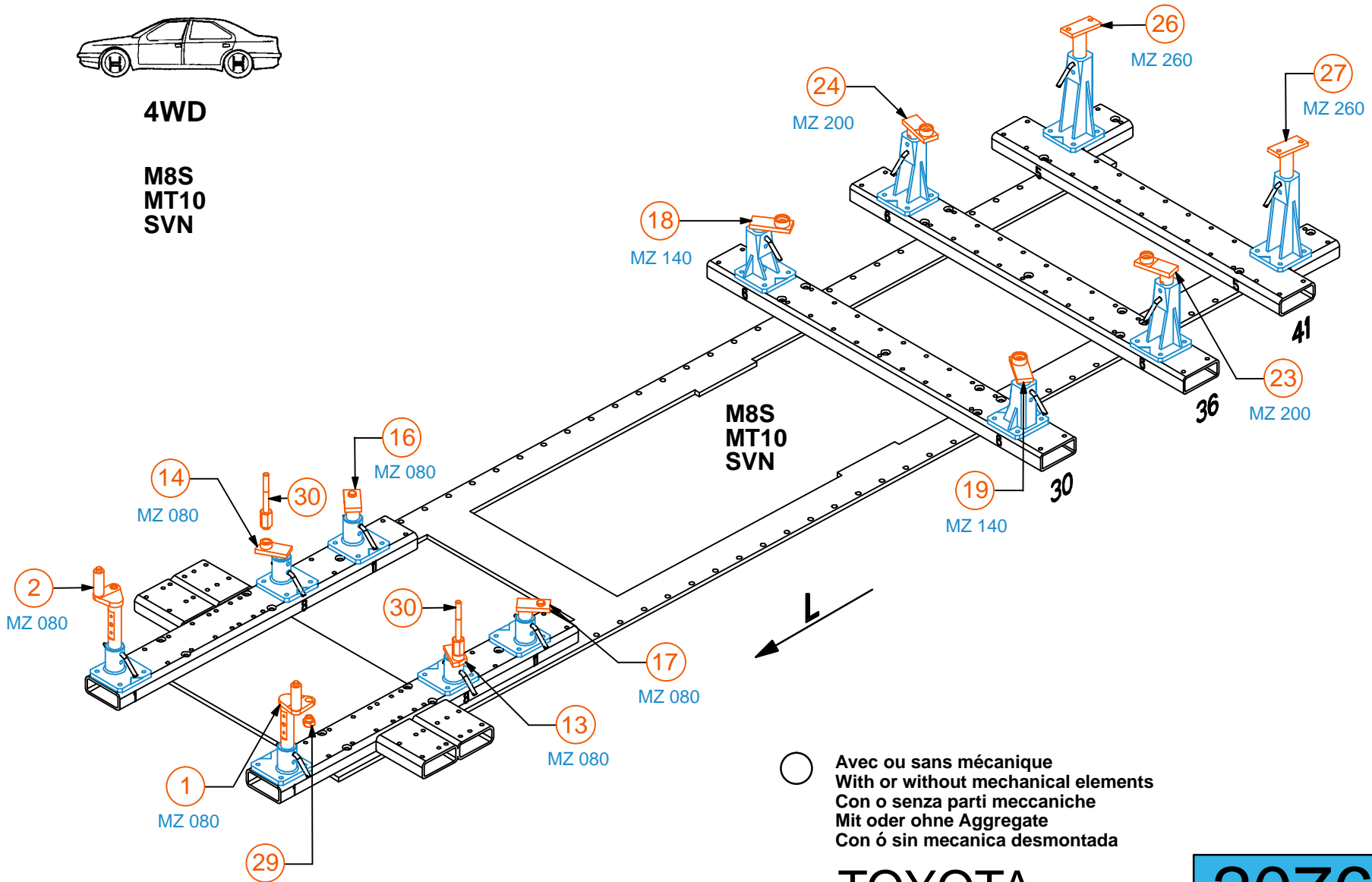

TOYOTA

2076.300		
56 Kg	16.09.2005	434-D-83D

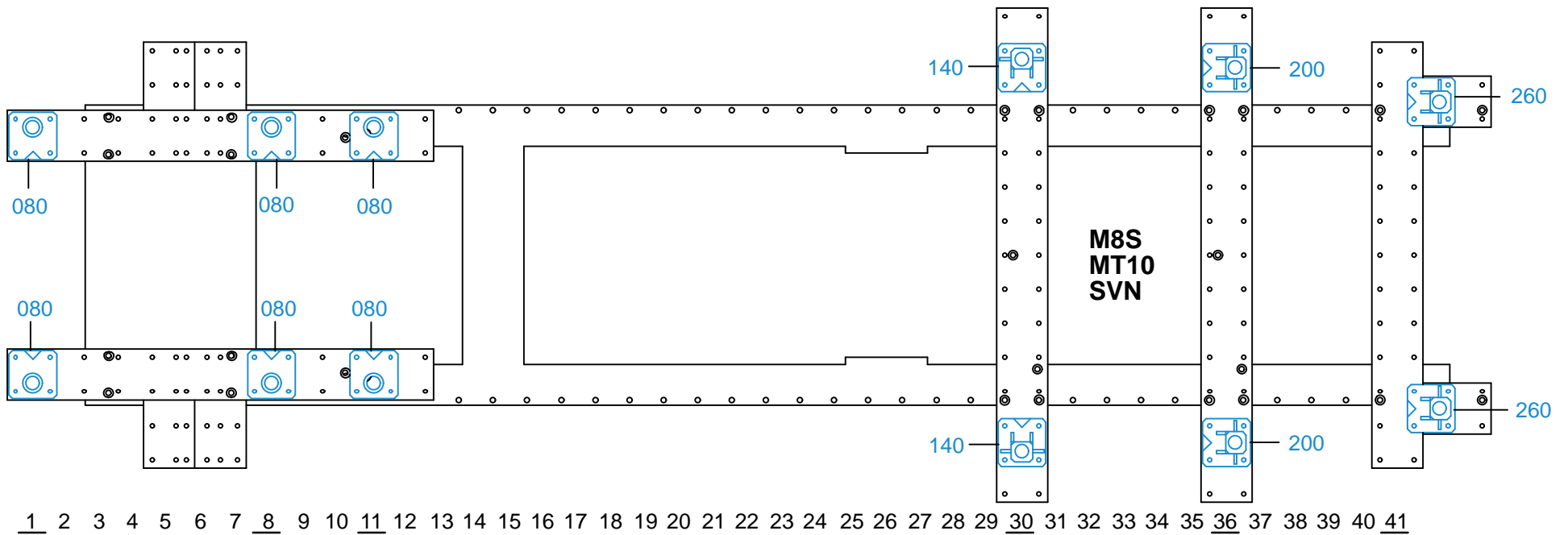

1 2 3 4 5 6 7 8 9 10 11 12 13 14 15 16 17 18 19 20 21 22 23 24 25 26 27 28 29 30 31 32 33 34 35 36 37 38 39 40 41

