

○ Avec ou sans mécanique  
 With or without mechanical elements  
 Con o senza parti meccaniche  
 Mit oder ohne Aggregate  
 Con ó sin mecanica desmontada

REP.	REFERENCE	PDS	NB	MZ
1	2042.7001	3,2	1	141
2	2042.7002	3,2	1	142
3	2042.7003	2,3	1	
4	2042.7004	2,3	1	
5	2042.7005	3,8	1	200
6	2042.7006	3,4	1	200
7	2042.7007	2,2	1	601
8	2042.7008	2,2	1	602
9	2042.7009	2,4	1	
10	2042.7010	2,6	1	260/080
11	2042.7011	2,6	1	260/080
12	2042.7012	0,9	2	
13	2042.7013	2,2	2	140
14	2042.7014	2,6	1	080
15	2042.7015	2,6	1	080
16	2042.7016	2,0	1	080
17	2042.7017	2,0	1	080
20	2042.7020	0,3	2	
28	2042.7028	1,0	1	
29	2042.7029	2,4	1	
31	2042.7031	3,0	1	260/200
32	2042.7032	3,0	1	260/200
33	2042.7033	3,1	1	260
34	2042.7034	3,6	1	260
35	2042.7035	3,4	2	200
36	2042.7036	2,4	1	
37	2042.7037	2,4	1	
	V32	0,1	2	

M 8-25	8
M 8-30	2
M 10-35	2
M 12-25	4
M 12-30	6
M 12-90	2
M 12-100	2
M 12-110	2
M 12-150	2
M 12-170	2
M 14-60	2
M 14-90	2
M 14-110	2
M 12	6
MU 12	2

**CITROEN**

**2069.300**

76 Kg 07.02.2005 408-D-19A

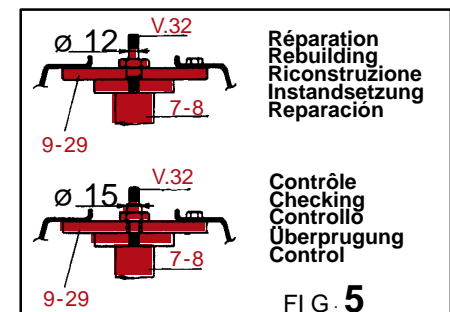
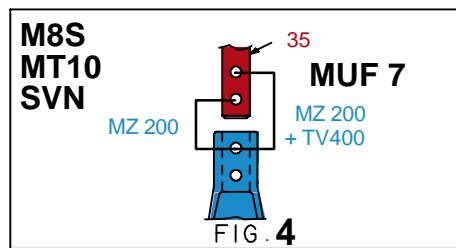
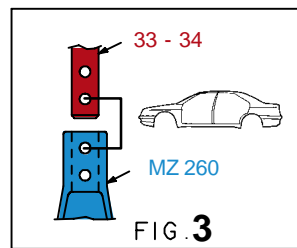
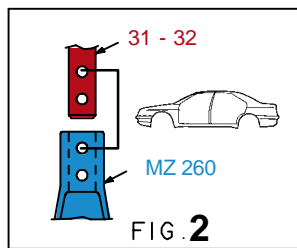
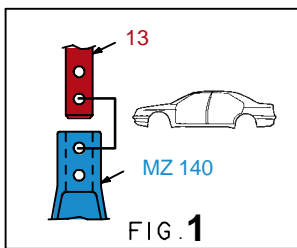
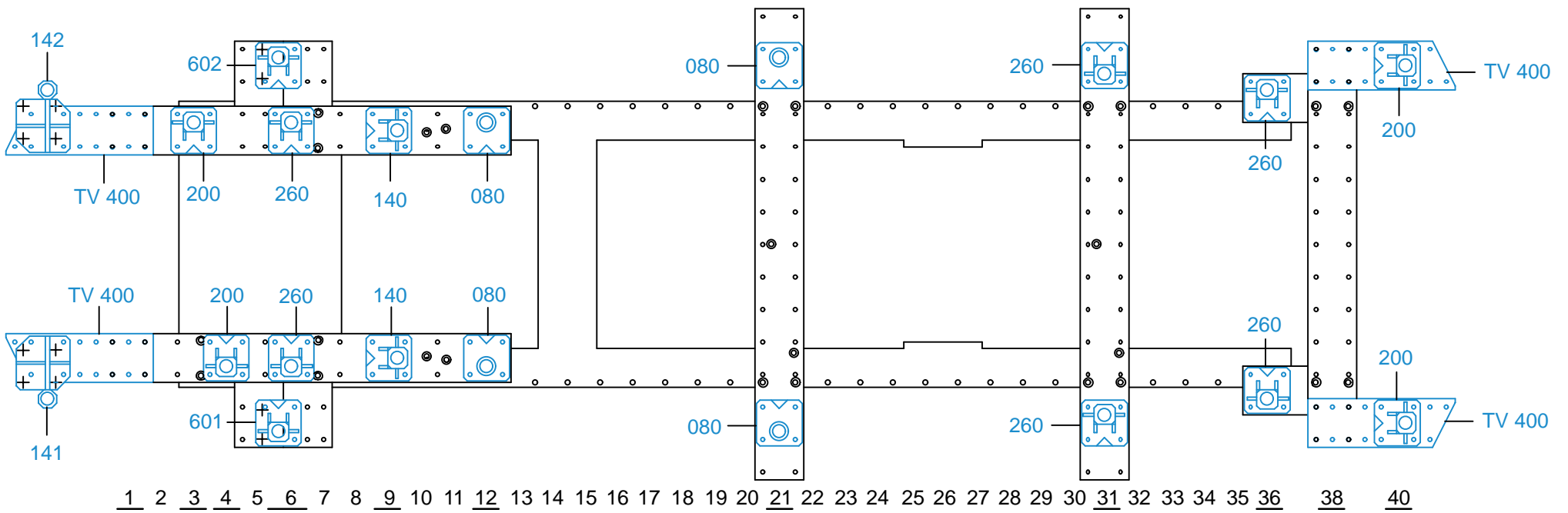

2069.300-RVA3-1 00

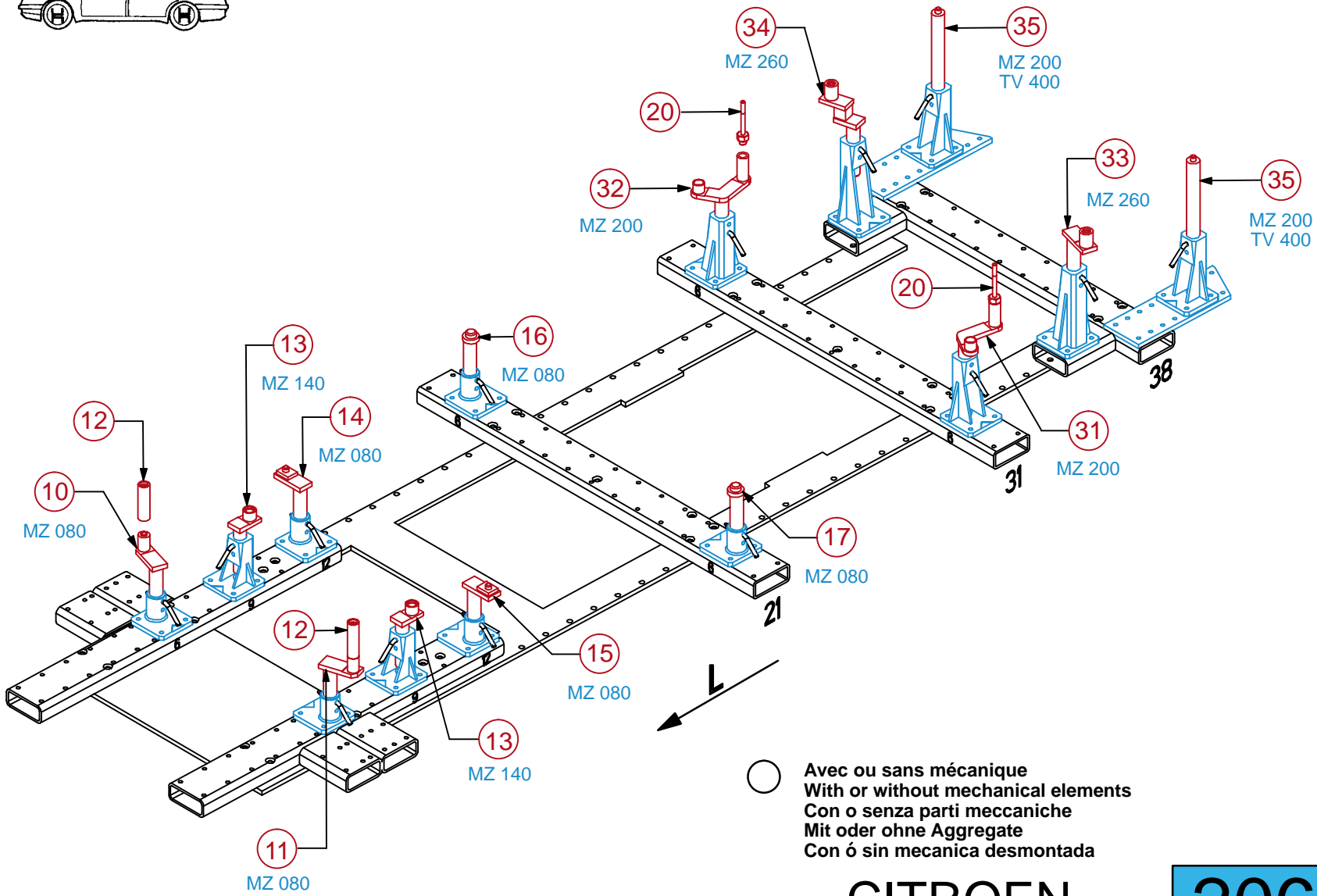
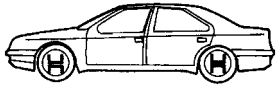

**CITROEN**

**2069.300**

76 Kg	07.02.2005	408-D-19B
-------	------------	-----------

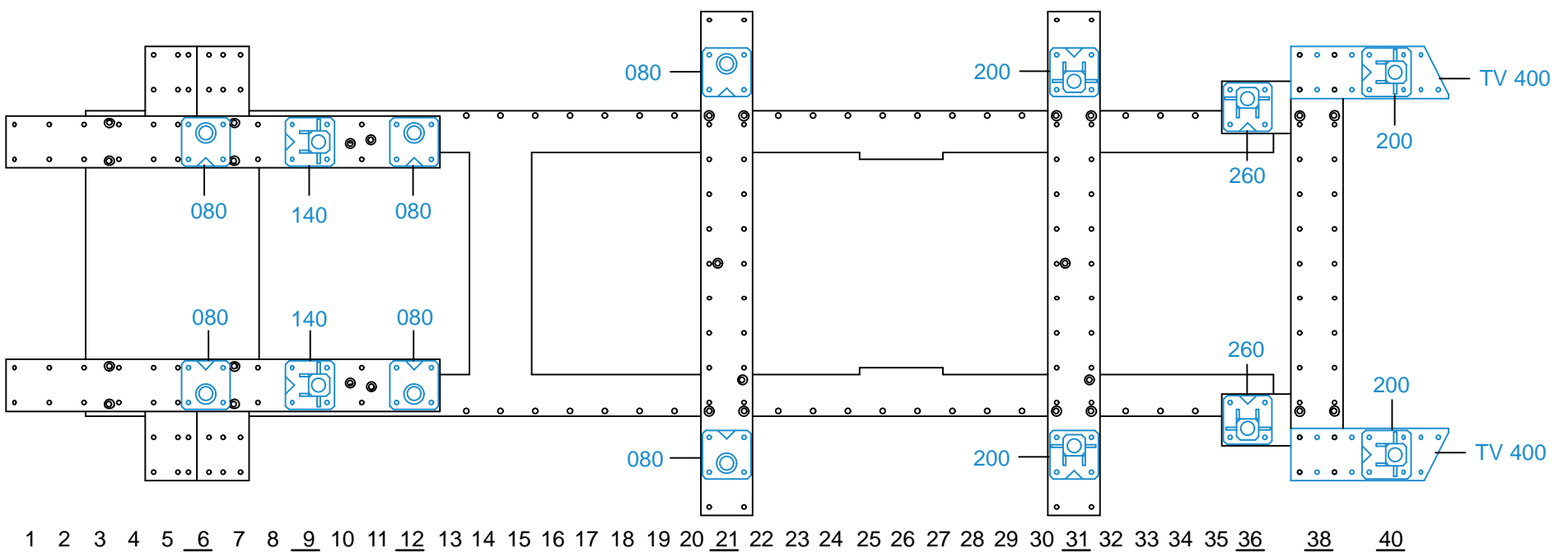

1 2 3 4 5 6 7 8 9 10 11 12 13 14 15 16 17 18 19 20 21 22 23 24 25 26 27 28 29 30 31 32 33 34 35 36 38 40

