

ANCRAGE DU VEHICULE  
ANCHORING OF THE VEHICLE  
VERANKERUNG DES FAHRZEUGS  
ANCORAGGIO DEL VEICOLO  
ANCLAJE DEL VEHICULO

**AN.27.B + AN27.03**

Ou/Or/Oder/O

**AN.34**

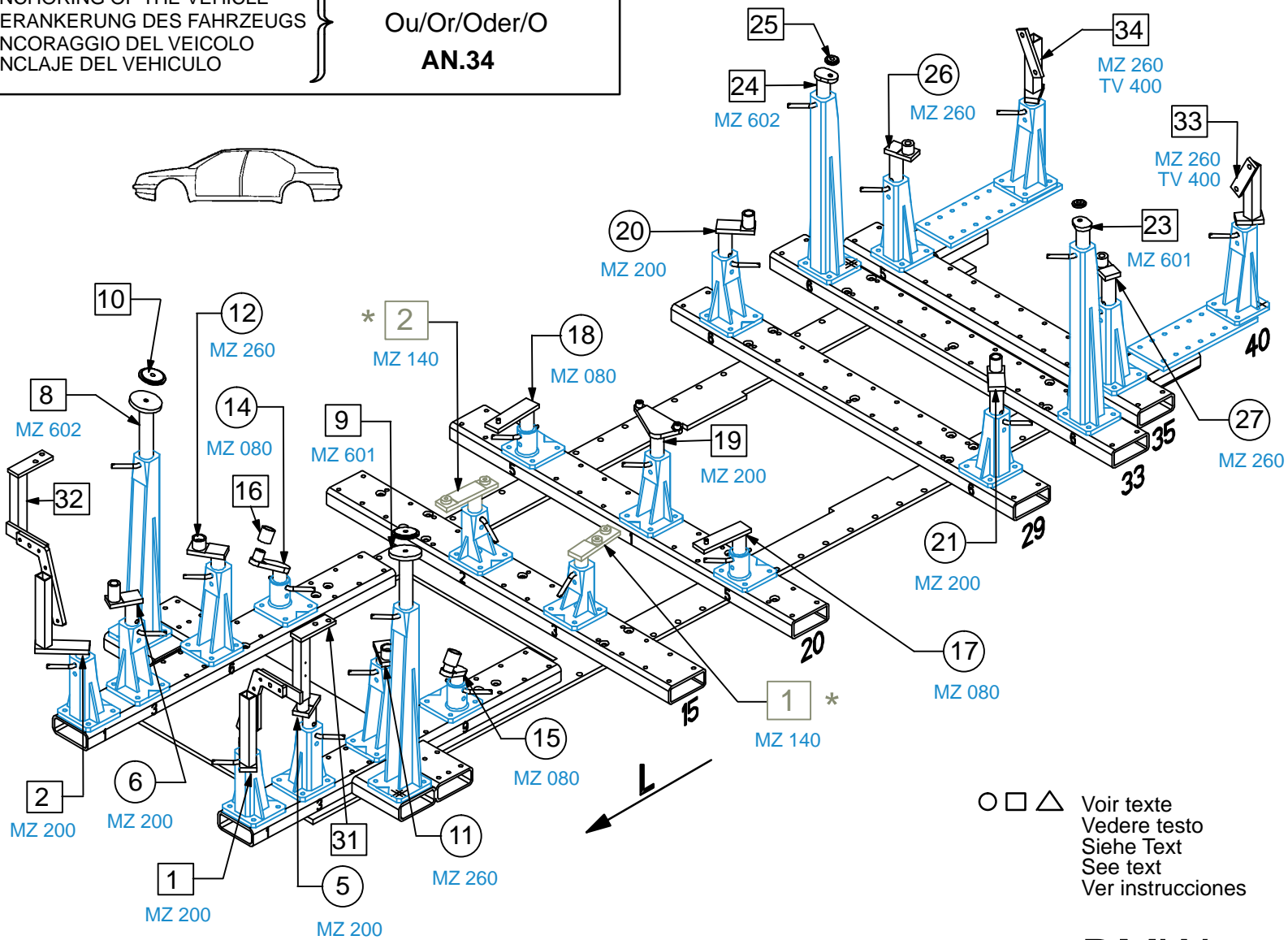

\* = 2067.309

REP.	REFERENCE	PDS	NB	MZ
* 1	2067.7001	2,0	1	140
* 2	2067.7002	2,3	1	140

M 8-35 4

complément au  
complementary set to  
complemento al  
zusatz zu

**2050.300 +  
2050.309**  
Ou/Or/Oder/O  
**2067.300**

**2067.309**

4,5 Kg 08.04.2005 406-D-24E

BMW

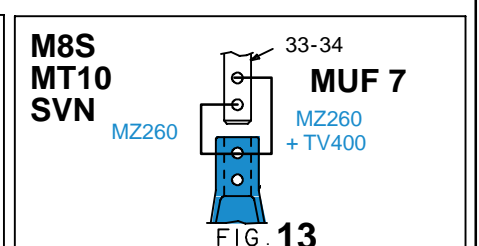
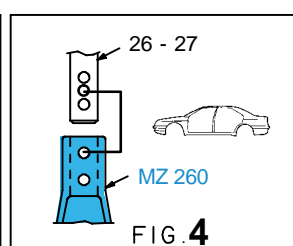
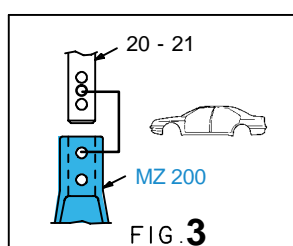
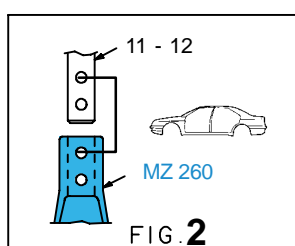
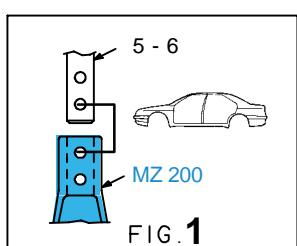
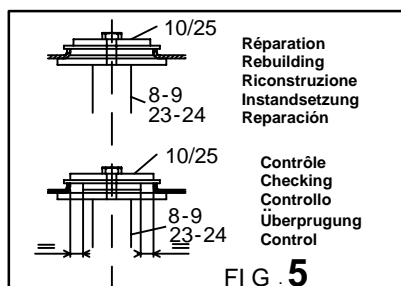
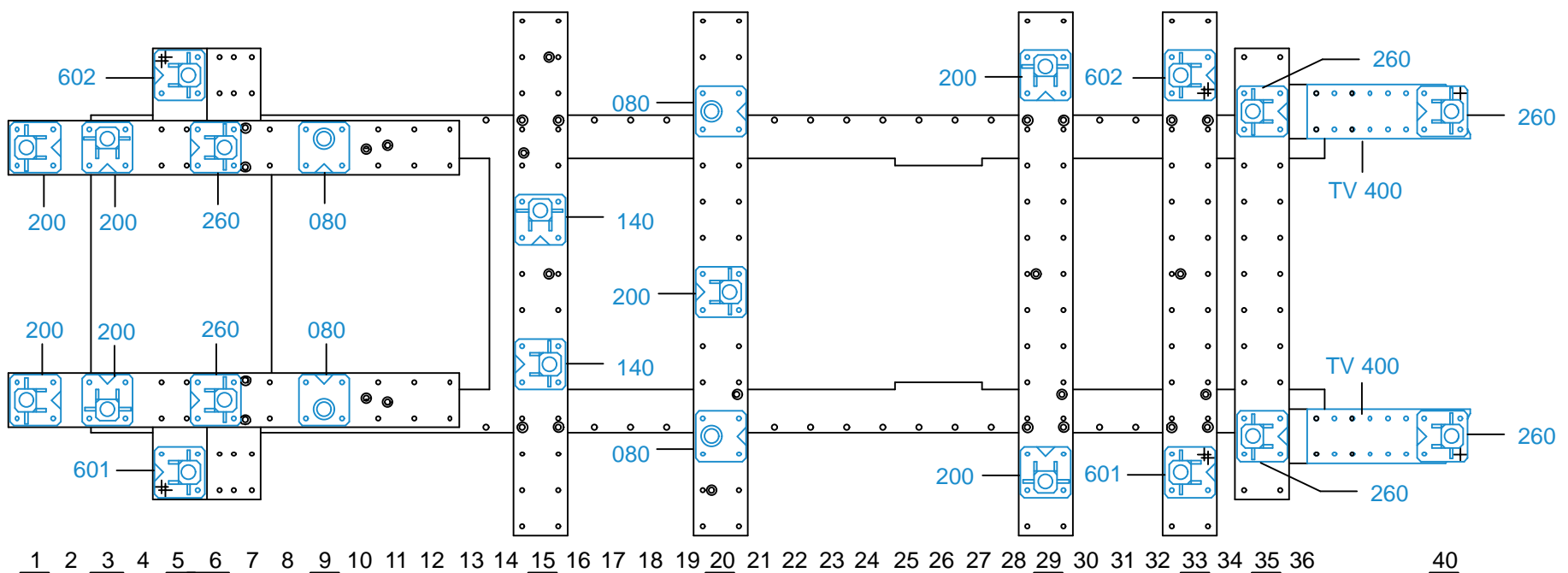

2067.309-RA3-1 00