

ANCRAGE DU VEHICULE  
ANCHORING OF THE VEHICLE  
VERANKERUNG DES FAHRZEUGS  
ANCORAGGIO DEL VEICOLO  
ANCLAJE DEL VEHICULO

**AN.27.B + AN27.03**  
Ou/Or/Oder/O  
**AN.34**

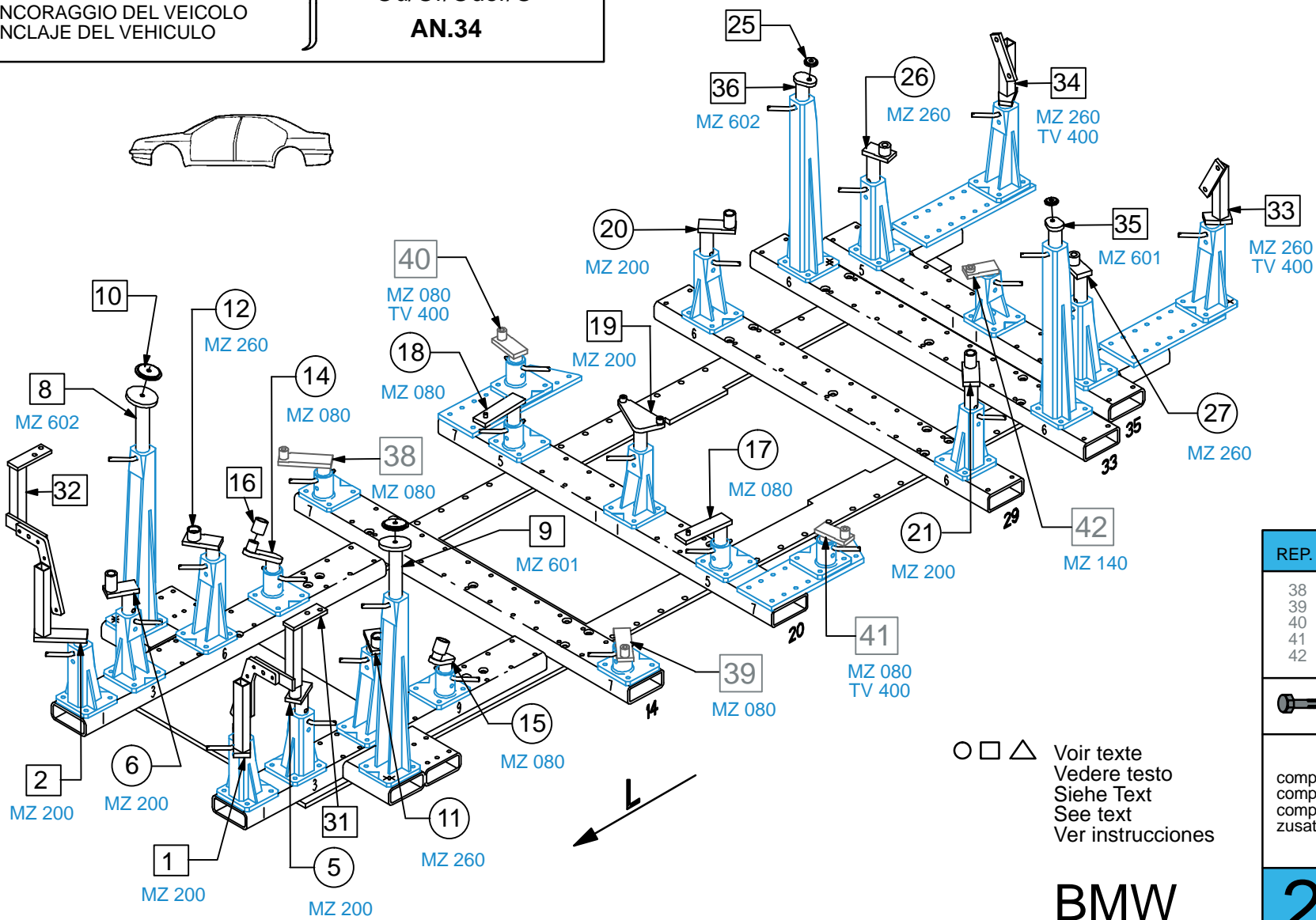

○ □ △ Voir texte  
Vedere testo  
Siehe Text  
See text  
Ver instrucciones

REP.	REFERENCE	PDS	NB	MZ
38	2050.7038	1,9	1	080
39	2050.7039	1,9	1	080
40	2050.7040	1,6	1	080
41	2050.7041	1,6	1	080
42	2050.7042	1,4	1	140

⚙ M 12x1,50-50  
M 12x1,50-70

1  
4

complément au  
complementary set to  
complemento al  
zusatz zu

**2050.310 +  
2050.309 +**  
Ou/Or/Oder/O  
**2067.310**

**2067.305**

9 Kg 05.12.2006 406-D-24M

BMW

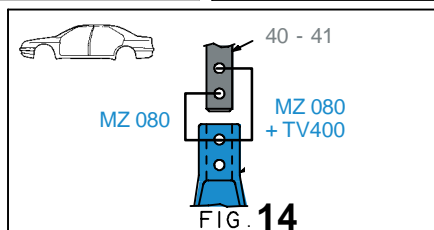
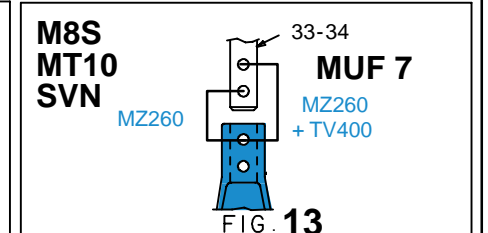
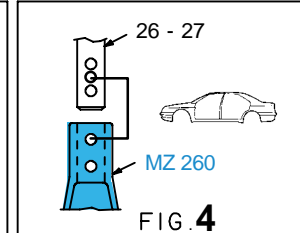
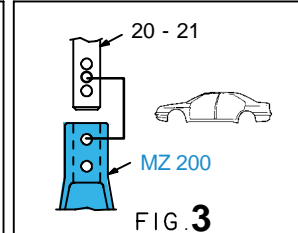
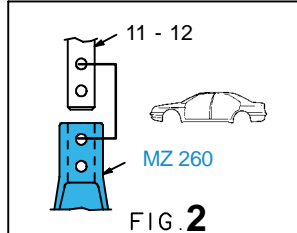
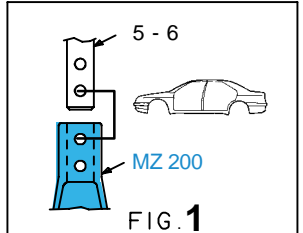
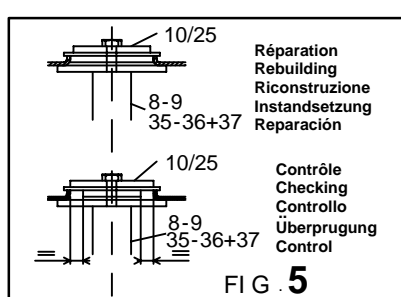
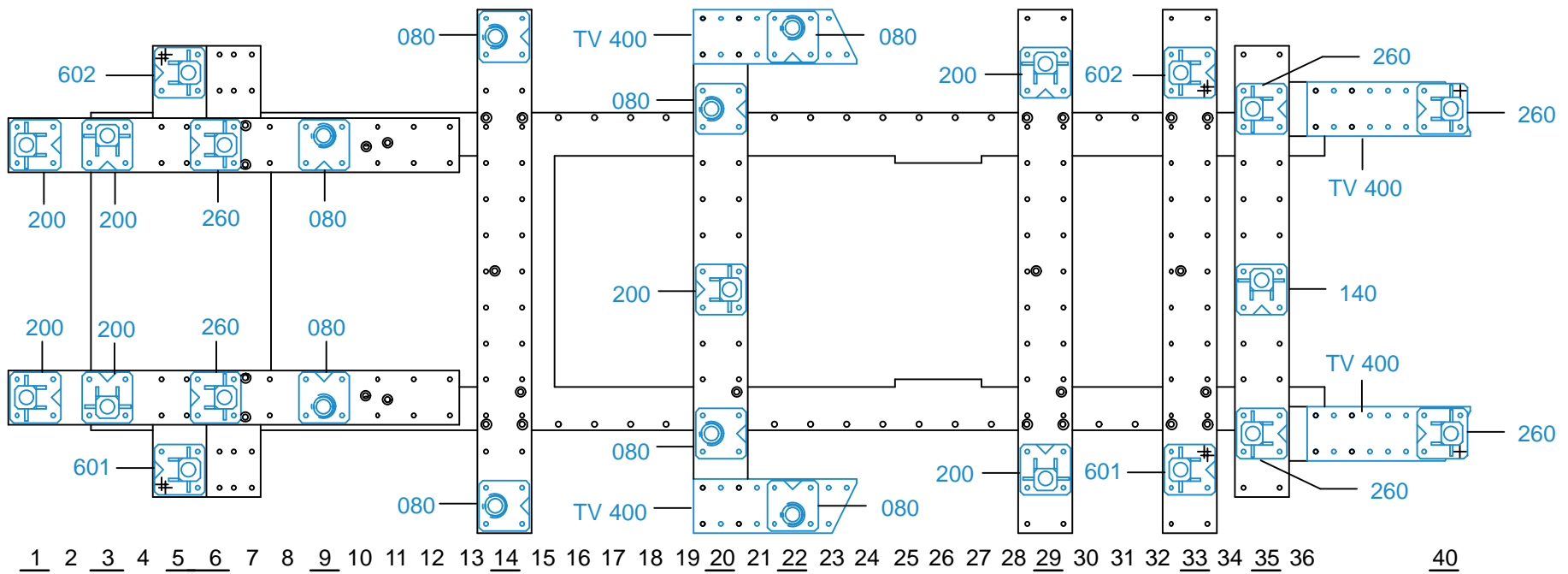

2067.305-RVA3-1 00

ANCRAGE DU VEHICULE  
ANCHORING OF THE VEHICLE  
VERANKERUNG DES FAHRZEUGS  
ANCORAGGIO DEL VEICOLO  
ANCLAJE DEL VEHICULO

**AN.27.B + AN27.03**  
Ou/Or/Oder/O  
**AN.34**

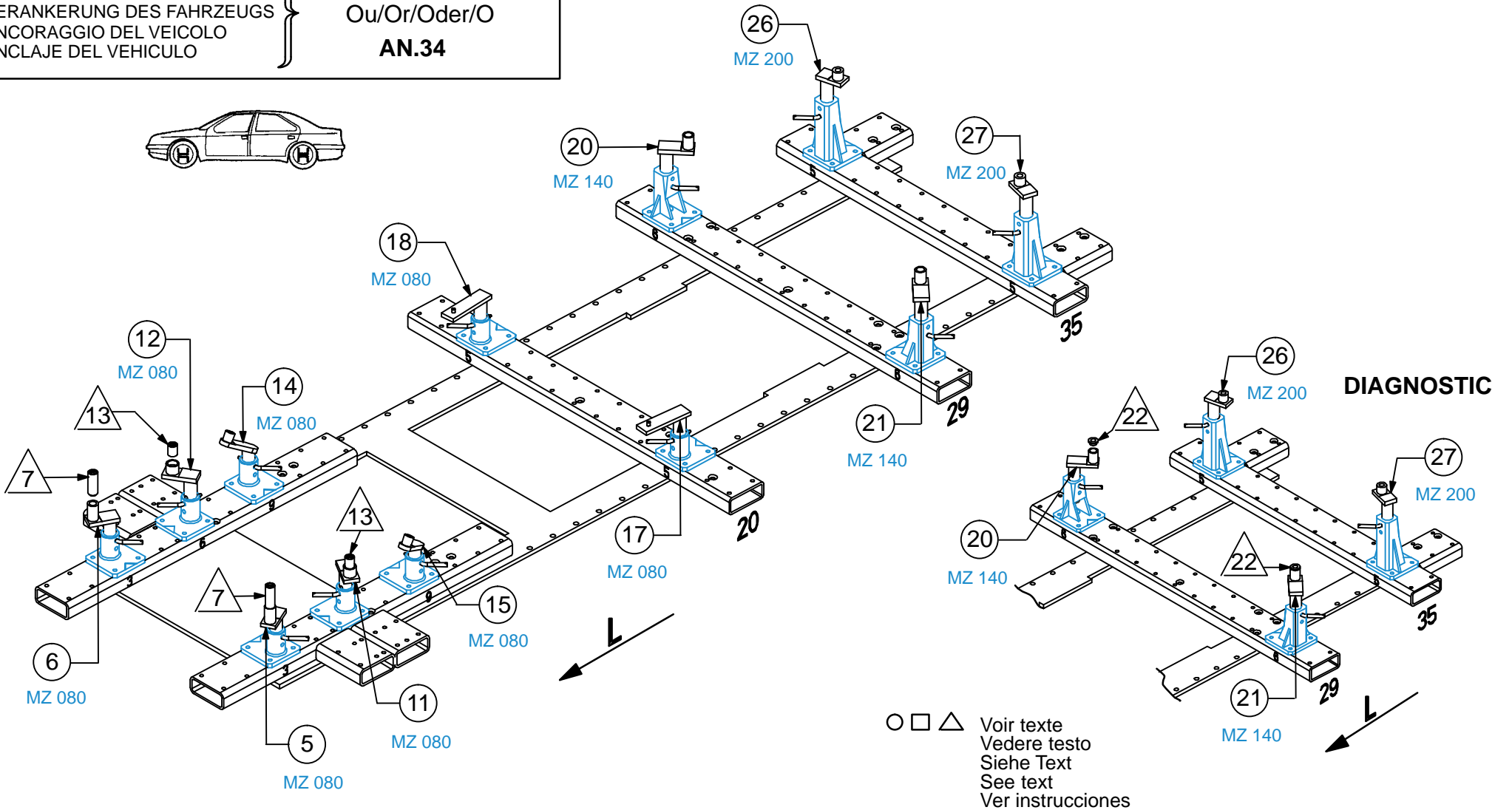

**BMW**

**2067.305**

9 Kg 05.12.2006 406-D-24N

