

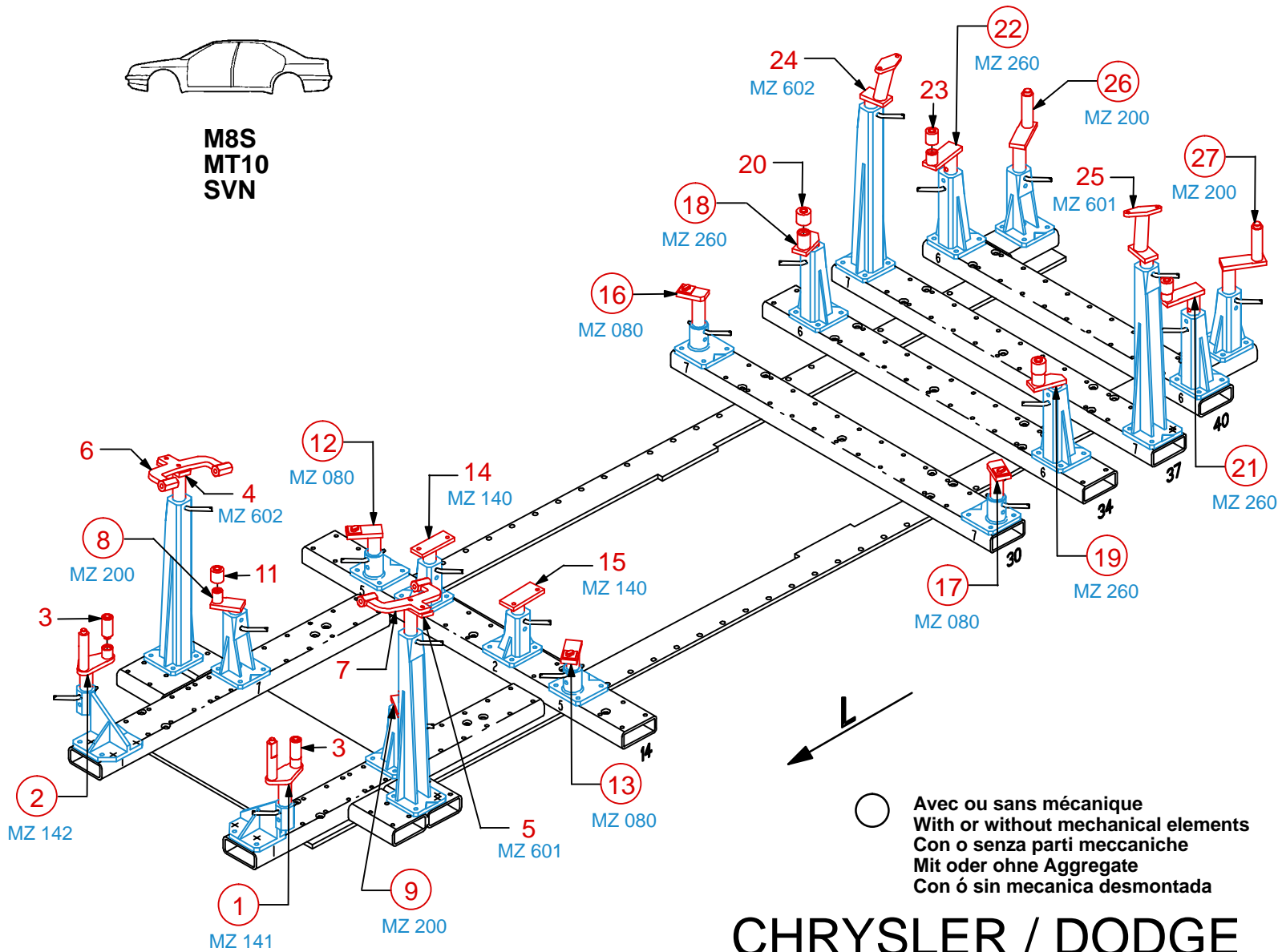

**M8S
MT10
SVN**



○ Avec ou sans mécanique
With or without mechanical elements
Con o senza parti meccaniche
Mit oder ohne Aggregate
Con ó sin mecanica desmontada

CHRYSLER / DODGE

REP.	REFERENCE	PDS	NB	MZ
1	2063.7001	3,3	1	141
2	2063.7002	3,3	1	142
3	2063.7003	0,4	2	
4	2063.7004	2,2	1	602
5	2063.7005	2,2	1	601
6	2063.7006	2,4	1	
7	2063.7007	2,4	1	
8	2063.7008	1,7	1	200/080
9	2063.7009	1,7	1	200/080
10	2063.7010	0,6	2	
11	2063.7011	0,3	2	
12	2063.7012	1,9	1	080
13	2063.7013	1,9	1	080
14	2063.7014	1,8	1	140
15	2063.7015	2,0	1	140
16	2063.7016	2,1	1	080
17	2063.7017	2,1	1	080
18	2063.7018	2,0	1	260/200
19	2063.7019	2,0	1	260/200
20	2063.7020	0,4	2	
21	2063.7021	2,7	1	260
22	2063.7022	2,7	1	260
23	2063.7023	0,3	2	
24	2063.7024	2,2	1	602
25	2063.7025	2,2	1	601
26	2063.7026	3,3	1	200
27	2063.7027	3,3	1	200

	M 10-30	8
	M 12-25	4
	M 12-65	2
	M 12-80	4
	M 14-130	2
	M 14-160	2
	M 14-180	4
	M 14-200	4

	M 12	4
--	------	---

2063.300

58 Kg 03.02.2005 442-D-13A

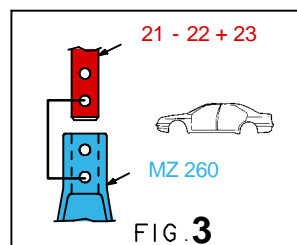
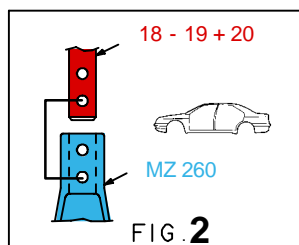
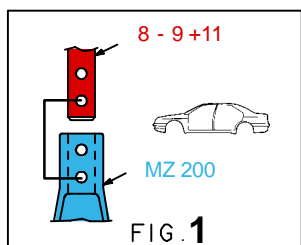
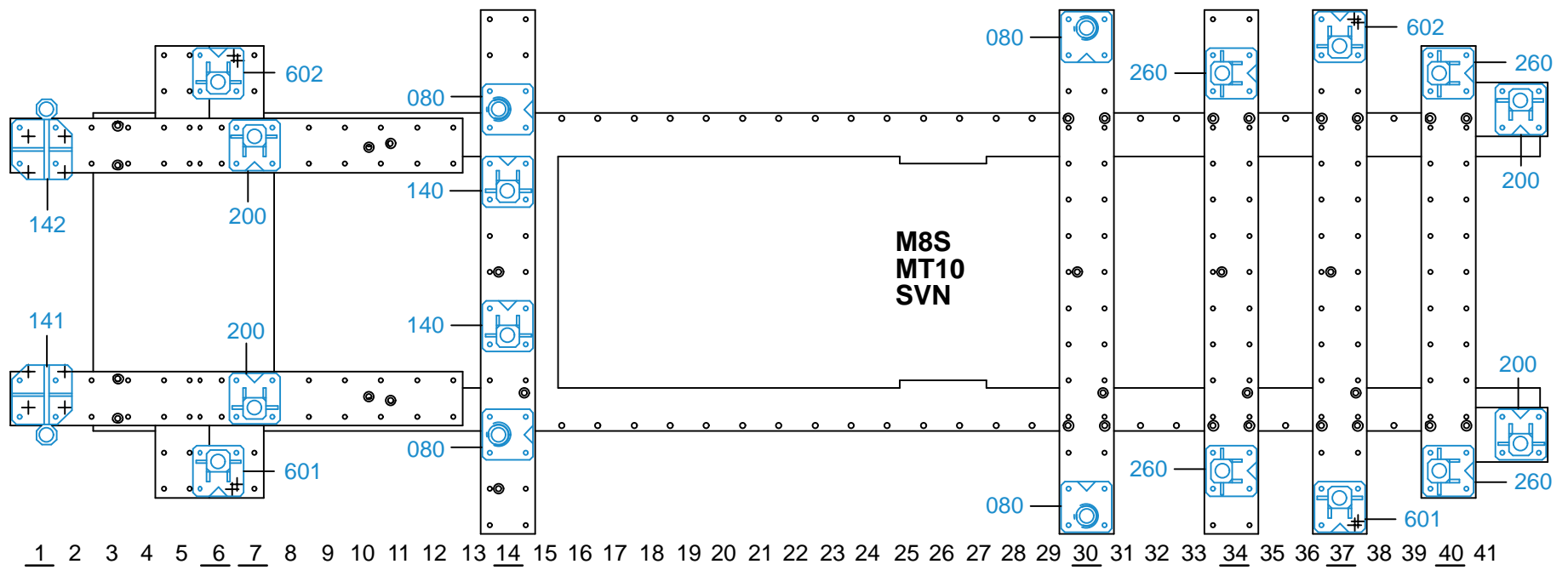

2063.300-RVA3-1 00

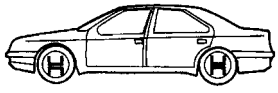

M8S
MT10
SVN

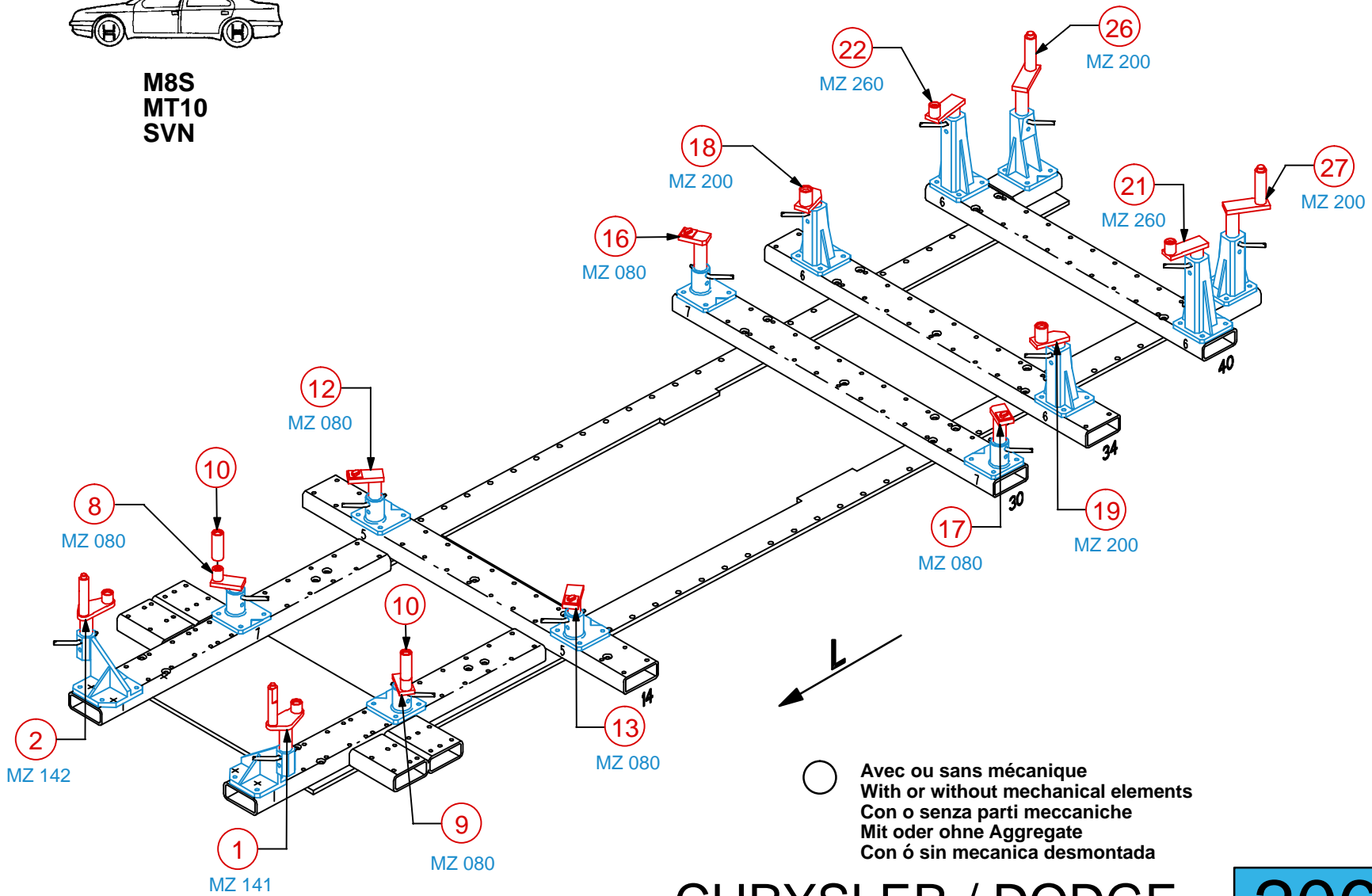

○ Avec ou sans mécanique
With or without mechanical elements
Con o senza parti meccaniche
Mit oder ohne Aggregate
Con ó sin mecanica desmontada

CHRYSLER / DODGE

2063.300

58 Kg	03.02.2005	442-D-13B
-------	------------	-----------

