

REP.	REFERENCE	PDS	NB	MZ
1	2061.7001	3,7	1	141
2	2061.7002	3,7	1	142
3	2061.7003	2,7	1	080
4	2061.7004	4,1	1	602
5	2061.7005	4,1	1	601
6	2061.7006	0,8	2	
7	2061.7007	1,8	1	260/080
8	2061.7008	1,8	1	260/080
9	2061.7009	1,1	2	
10	2061.7010	0,3	2	
11	2061.7011	1,7	1	140/080
12	2061.7012	1,7	1	140/080
13	2061.7013	3,6	1	080
14	2061.7014	3,6	1	080
15	2061.7015	2,6	1	140
16	2061.7016	2,6	1	140
17	2061.7017	3,2	1	200
18	2061.7018	3,2	1	200
19	2061.7019	2,8	1	601
20	2061.7020	2,8	1	602
21	2061.7021	0,1	2	
22	2061.7022	2,7	1	260
23	2061.7023	2,7	1	260

	M 12-30	2
	M 12-45	2
	M 14-20	2
	M 10x1,25-35	6
	M 10x1,25-125	2
	M 12x1,25-40	2
	M 14x1,50-70	2
	M 14x1,50-120	2
	M 14x1,50	2

○ Avec ou sans mécanique
 With or without mechanical elements
 Con o senza parti meccaniche
 Mit oder ohne Aggregate
 Con ó sin mecanica desmontada

HYUNDAI

2061.300

61 Kg 10.11.2004 447-D-15A

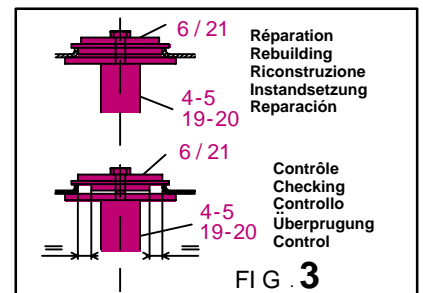
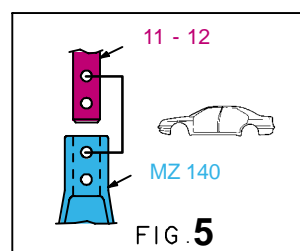
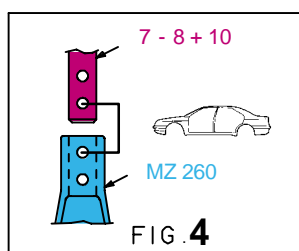
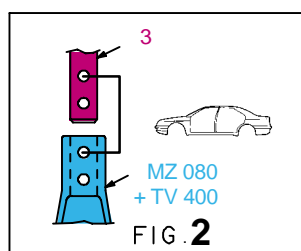
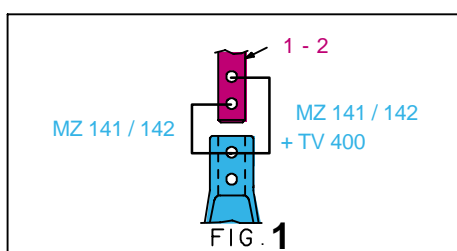
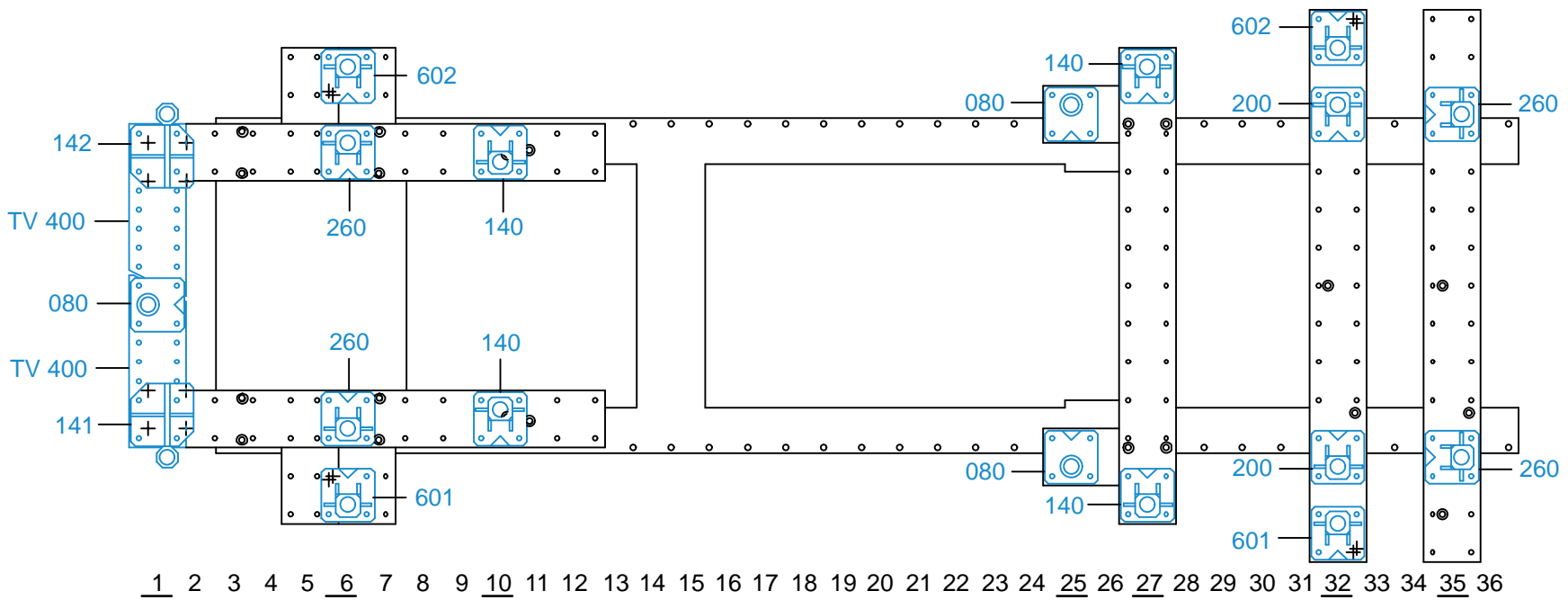

2061.300-RVA3-1 00

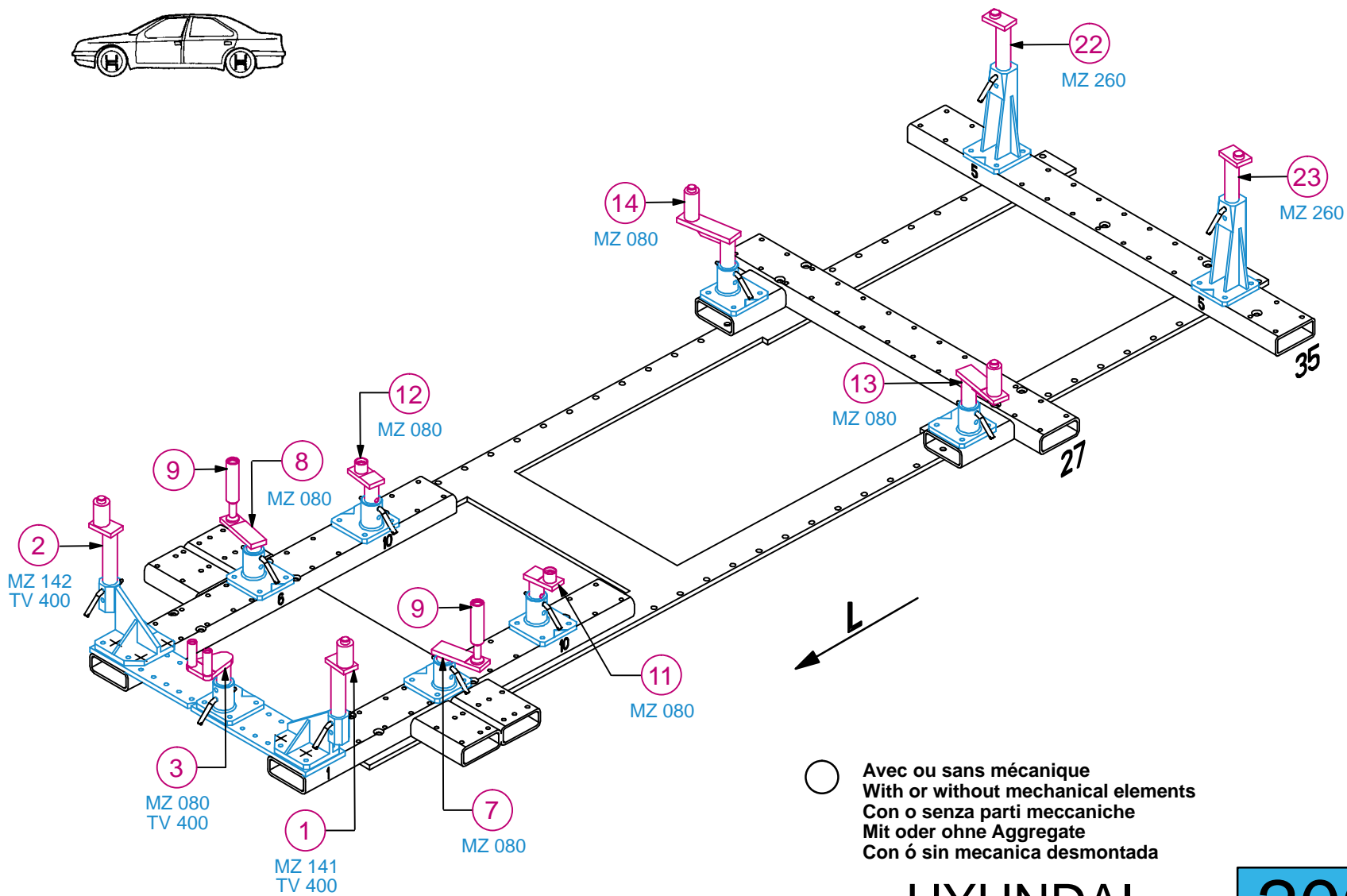

○ Avec ou sans mécanique
 With or without mechanical elements
 Con o senza parti meccaniche
 Mit oder ohne Aggregate
 Con ó sin mecánica desmontada

HYUNDAI

2061.300		
61 Kg	10.11.2004	447-D-15B

