

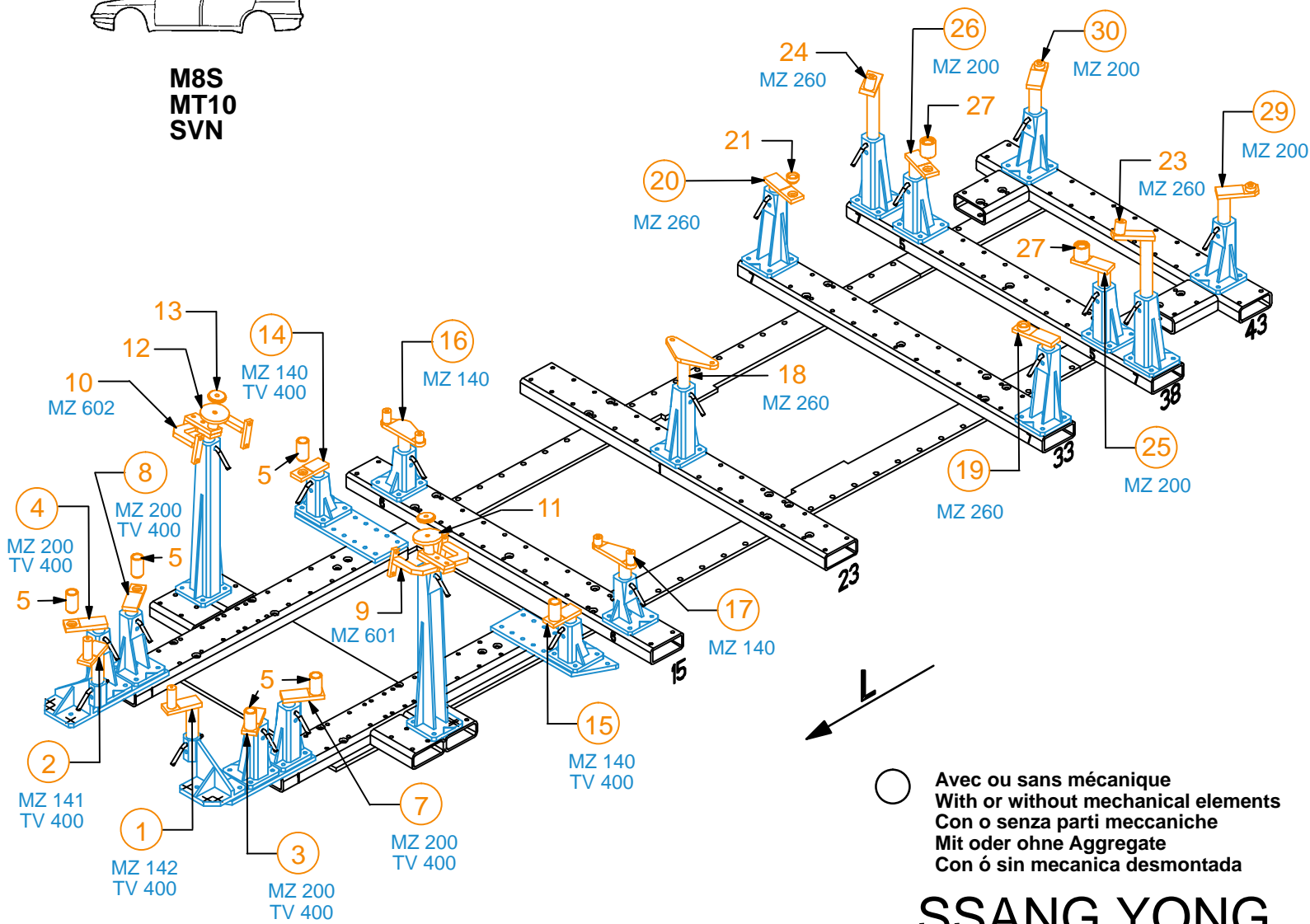

**M8S  
MT10  
SVN**



○ Avec ou sans mécanique  
With or without mechanical elements  
Con o senza parti meccaniche  
Mit oder ohne Aggregate  
Con ó sin mecanica desmontada

**SSANG YONG**

REP.	REFERENCE	PDS	NB	MZ
1	2055.7001	3,1	1	141
2	2055.7002	3,1	1	142
3	2055.7003	1,6	1	200/140
4	2055.7004	1,6	1	200/140
5	2055.7005	0,4	6	
6	2055.7006	0,3	6	
7	2055.7007	1,6	1	200/140
8	2055.7008	1,6	1	200/140
9	2055.7009	3,5	1	601
10	2055.7010	3,5	1	602
11	2055.7011	1,4	1	
12	2055.7012	1,4	1	
13	2055.7013	0,2	2	
14	2055.7014	1,5	1	140/080
15	2055.7015	1,5	1	140/080
16	2055.7016	2,9	1	140
17	2055.7017	2,9	1	140
18	2055.7018	3,2	1	260
19	2055.7019	1,7	1	260/200
20	2055.7020	1,7	1	260/200
21	2055.7021	0,1	2	
22	2055.7022	0,1	2	
23	2055.7023	2,3	1	260
24	2055.7024	2,3	1	260
25	2055.7025	2,1	1	200/140
26	2055.7026	2,1	1	200/140
27	2055.7027	0,6	2	
28	2055.7028	0,6	2	
29	2055.7029	2,6	1	200
30	2055.7030	2,6	1	200

M 12-20	2
M 12-25	4
M 12-30	2
M 14-90	2
M 10x1,25-70	2
M 10x1,25-90	2
M 12x1,25-30	2
M 12x1,50-45	2
M 12x1,50-100	2
M 14x1,50-130	6

M 14	2
------	---

**2055.300**

61 Kg	21.03.2006	456-D-4A
-------	------------	----------

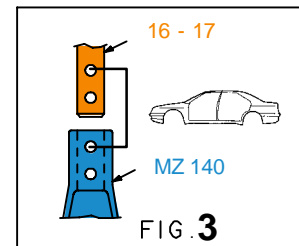
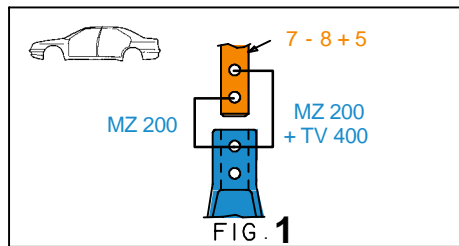
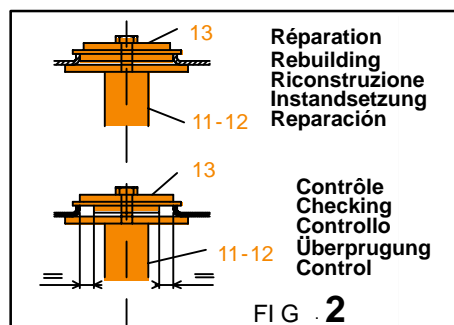
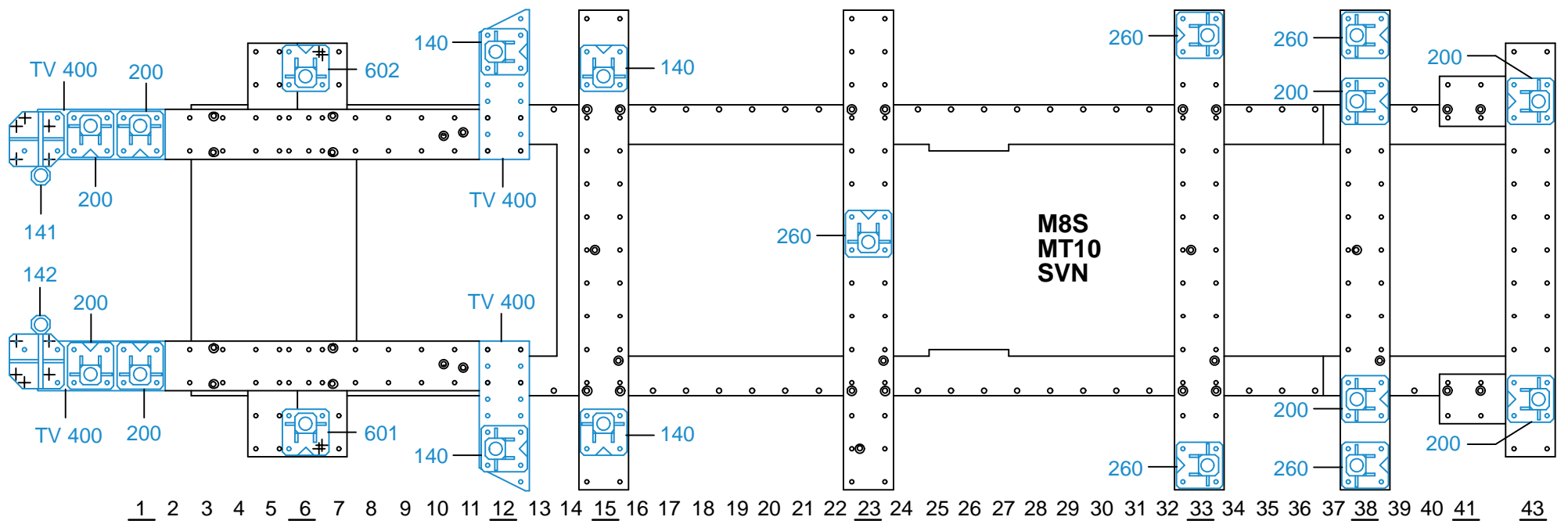

2055.300-RVA3-1 00

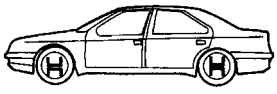

**M8S  
MT10  
SVN**

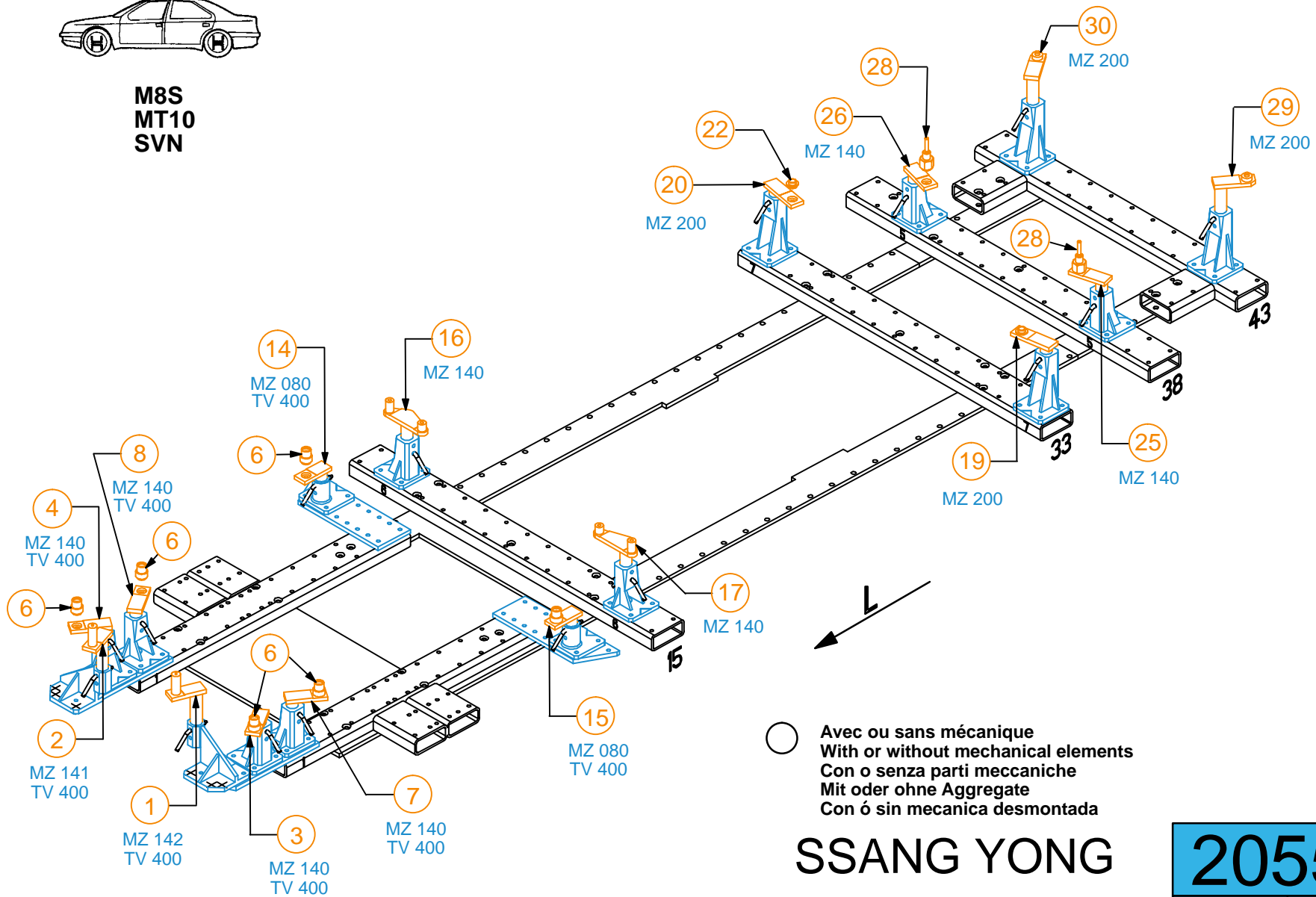

○ Avec ou sans mécanique  
 With or without mechanical elements  
 Con o senza parti meccaniche  
 Mit oder ohne Aggregate  
 Con ó sin mecanica desmontada

**SSANG YONG**

<b>2055.300</b>		
61 Kg	21.03.2006	456-D-4B

