

○ Avec ou sans mécanique
 With or without mechanical elements
 Con o senza parti meccaniche
 Mit oder ohne Aggregate
 Con ó sin mecanica desmontada

REP.	REFERENCE	PDS	NB	MZ
43	2051.7043	1,9	1	260
44	2051.7044	1,9	1	260

complément au
 complementary set to
 complemento al
 zusatz zu

2051.300
 +
2051.309

2051.308

4 Kg 12.12.2007 427-D-31E

RENAULT

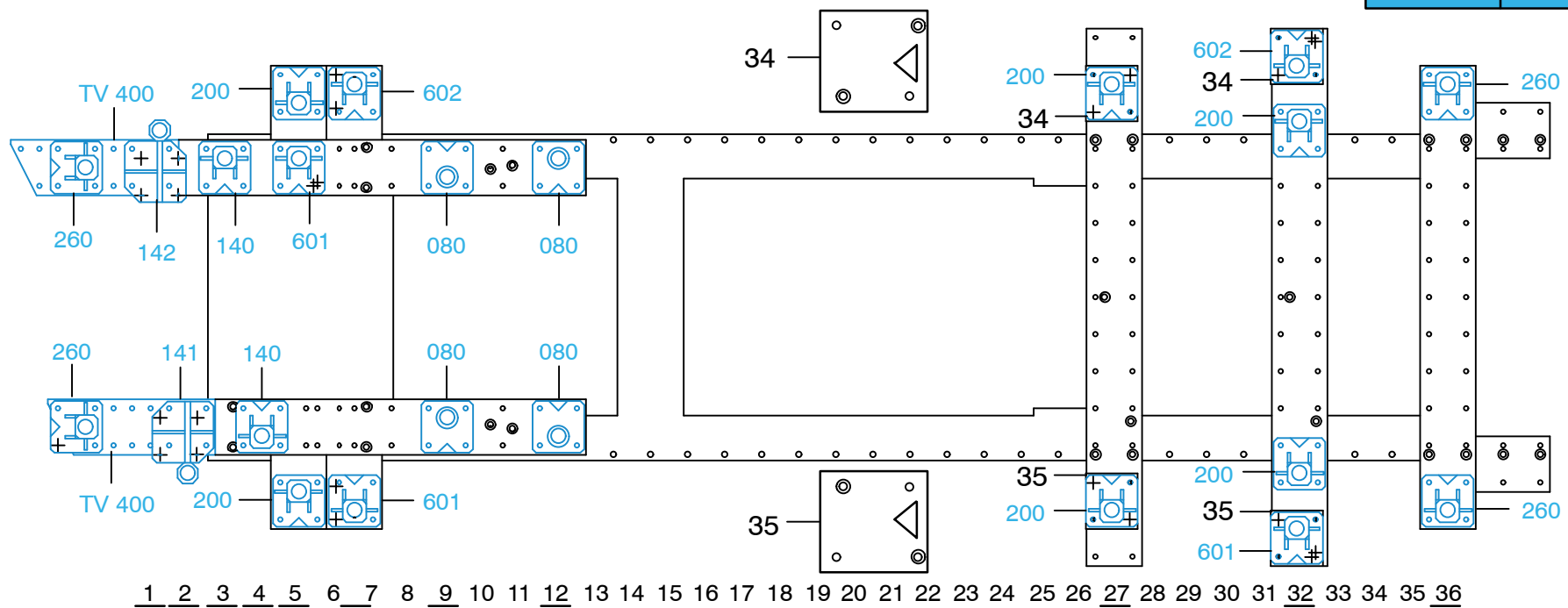

1 2 3 4 5 6 7 8 9 10 11 12 13 14 15 16 17 18 19 20 21 22 23 24 25 26 27 28 29 30 31 32 33 34 35 36

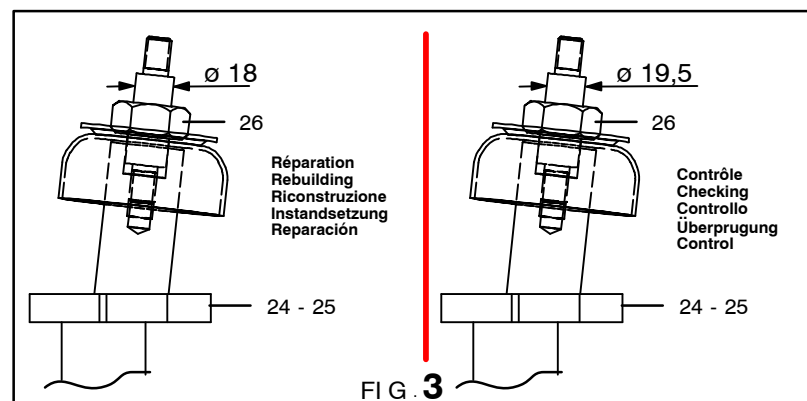
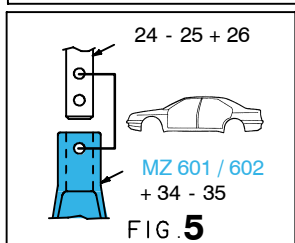
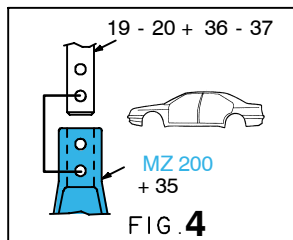
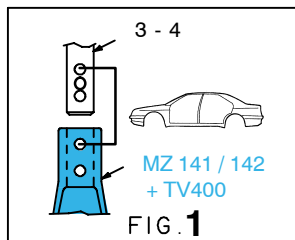
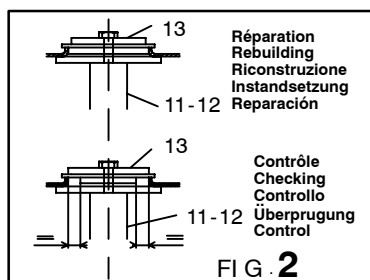

2051.308-RVA3-1 00

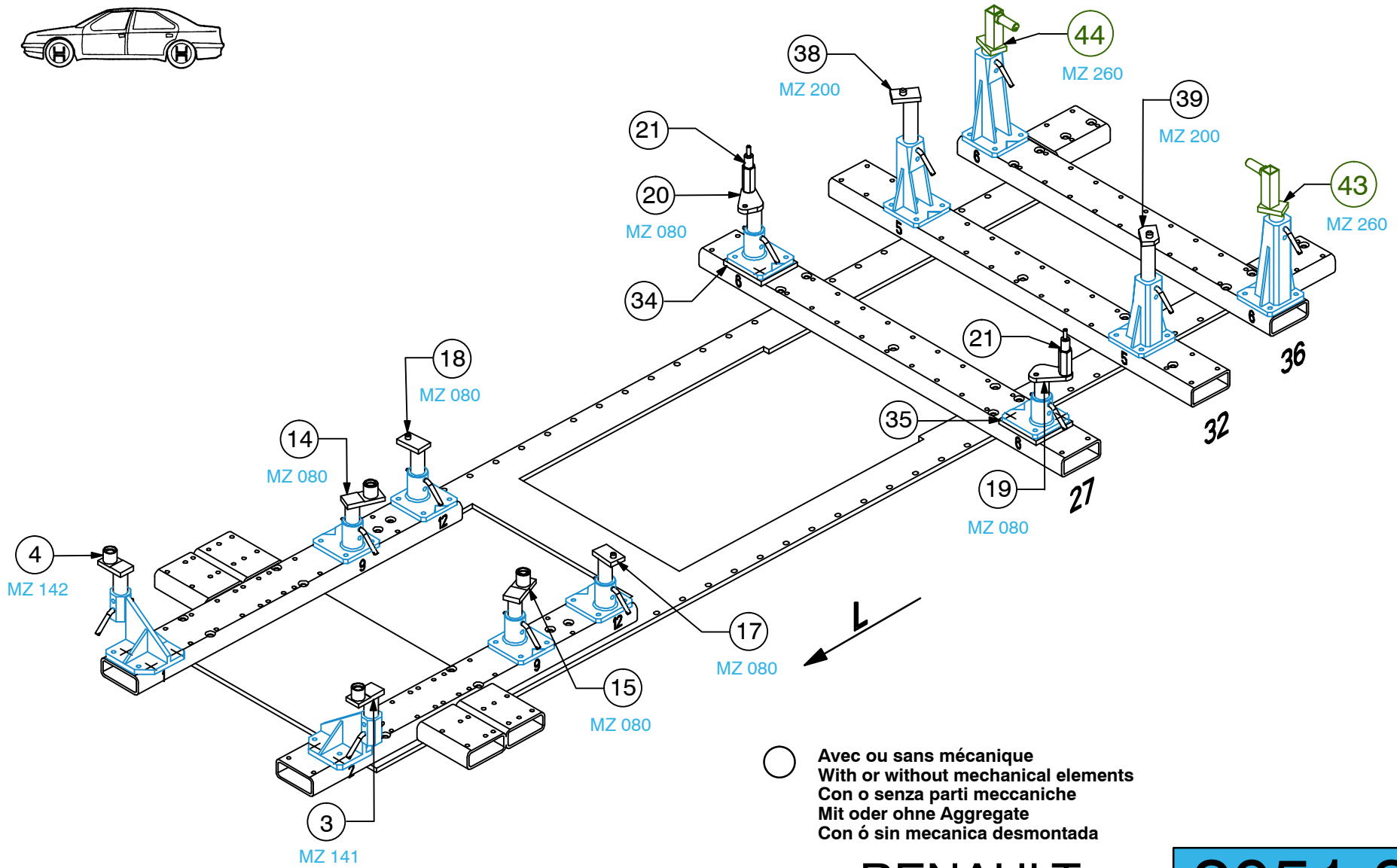
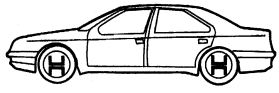

RENAULT

2051.308

4 Kg | 12.12.2007 | 427-D-31F

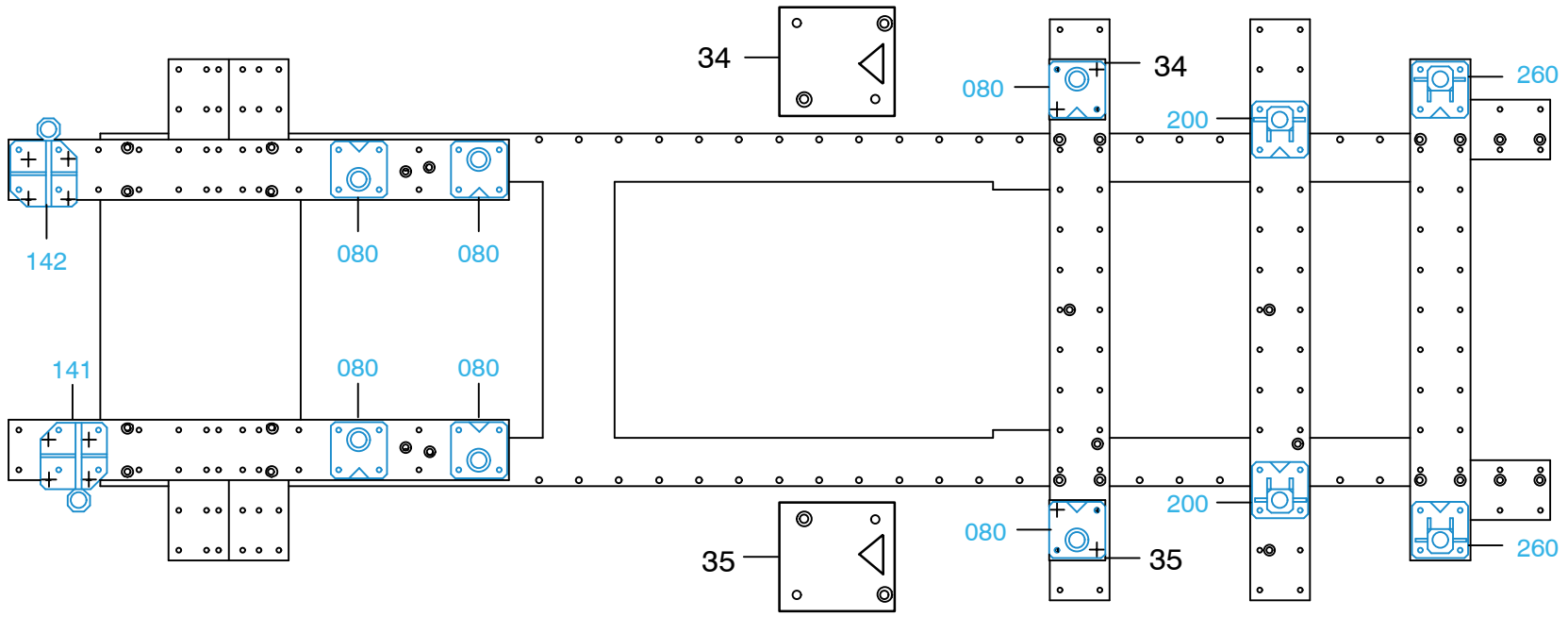

1 2 3 4 5 6 7 8 9 10 11 12 13 14 15 16 17 18 19 20 21 22 23 24 25 26 27 28 29 30 31 32 33 34 35 36

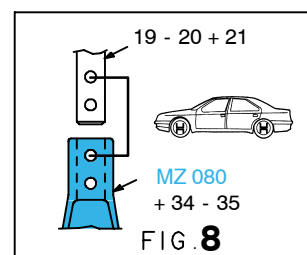
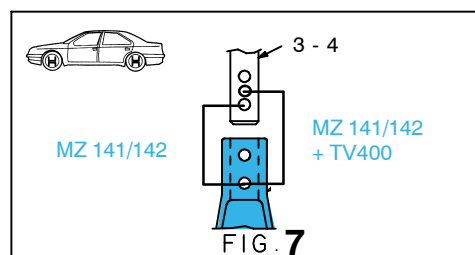

2051.308-RVA3-1 | 00