

REP.	REFERENCE	PDS	NB	MZ
1	2051.7001	4,8	1	260
2	2051.7002	4,8	1	260
3	2051.7003	2,2	1	141
4	2051.7004	2,1	1	142
5	2051.7005	2,8	1	140
6	2051.7006	2,8	1	140
7	2051.7007	3,0	1	601
8	2051.7008	2,6	1	
9	2051.7009	3,5	1	200
10	2051.7010	3,4	1	200
11	2051.7011	2,4	1	601
12	2051.7012	2,4	1	602
13	2051.7013	0,6	2	
14	2051.7014	2,3	1	080
15	2051.7015	2,3	1	080
16	2051.7016	0,6	2	
17	2051.7017	1,8	1	080
18	2051.7018	1,8	1	080
19	2051.7019	2,1	1	200/080
20	2051.7020	2,1	1	200/080
21	2051.7021	0,7	2	
22	2051.7022	0,05	2	
23	2051.7023	0,7	2	
24	2051.7024	2,2	1	602
25	2051.7025	2,2	1	601
26	2051.7026	0,2	2	
27	2051.7027	2,7	1	200
28	2051.7028	2,7	1	200
29	2051.7029	1,4	1	
30	2051.7030	1,4	1	
31	2051.7031	0,2	1	
32	2051.7032	0,2	1	
33	2051.7033	1,0	1	

M 10-20	2
M 10-30	4
M 10-40	2
M 10-50	2
M 12-25	4
M 12-60	2
M 12-70	3
M 12-80	3
M 12-100	1
M 12-160	2
M 14-30	2

M 10	2
M 14	2

○ Avec ou sans mécanique
With or without mechanical elements
Con o senza parti meccaniche
Mit oder ohne Aggregate
Con ó sin mecanica desmontada

RENAULT

2051.300

71 Kg | 01.06.2004 | 427-D-31A

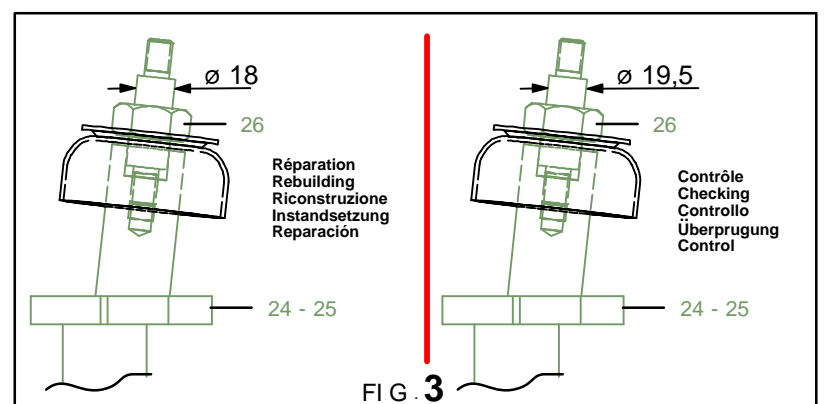
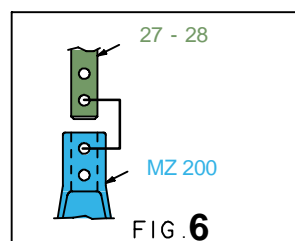
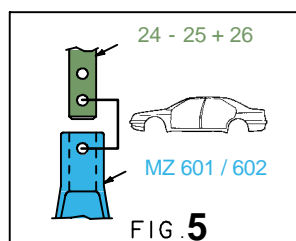
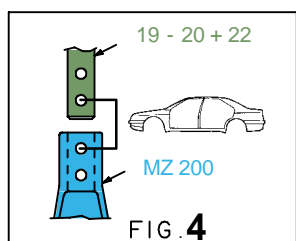
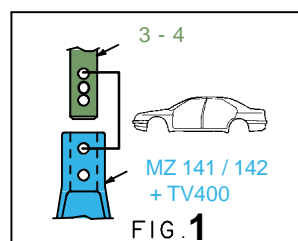
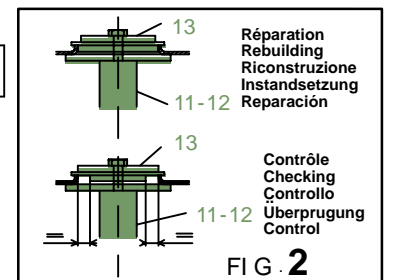
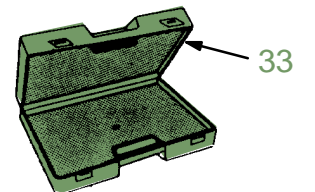
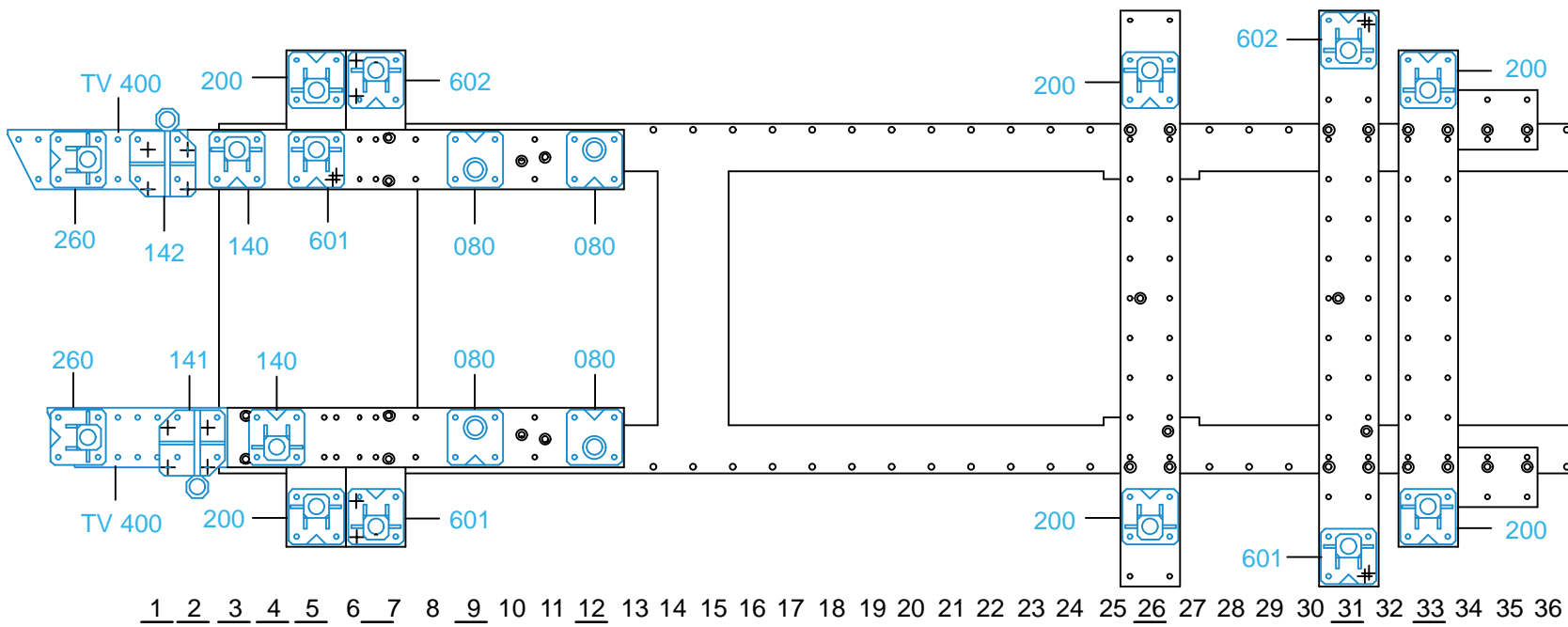

2051.300-RVA3-1 | 00

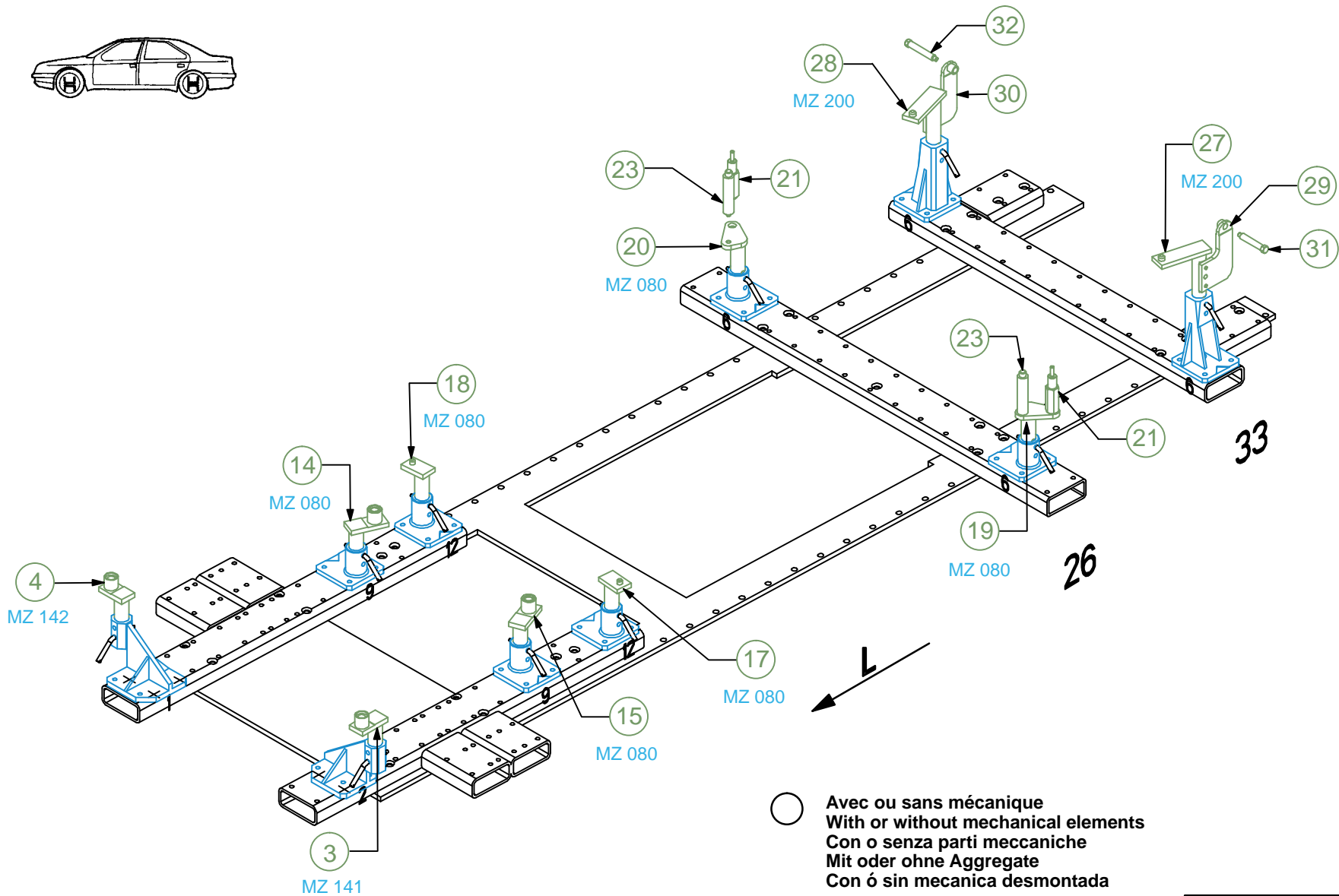
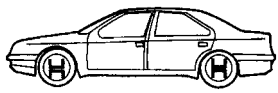

RENAULT

2051.300

71 Kg	01.06.2004	427-D-31B
-------	------------	-----------

