

ANCRAGE DU VEHICULE  
ANCHORING OF THE VEHICLE  
VERANKERUNG DES FAHRZEUGS  
ANCORAGGIO DEL VEICOLO  
ANCLAJE DEL VEHICULO

**AN.27.B + AN27.03**  
Ou/Or/Oder/O  
**AN.34**

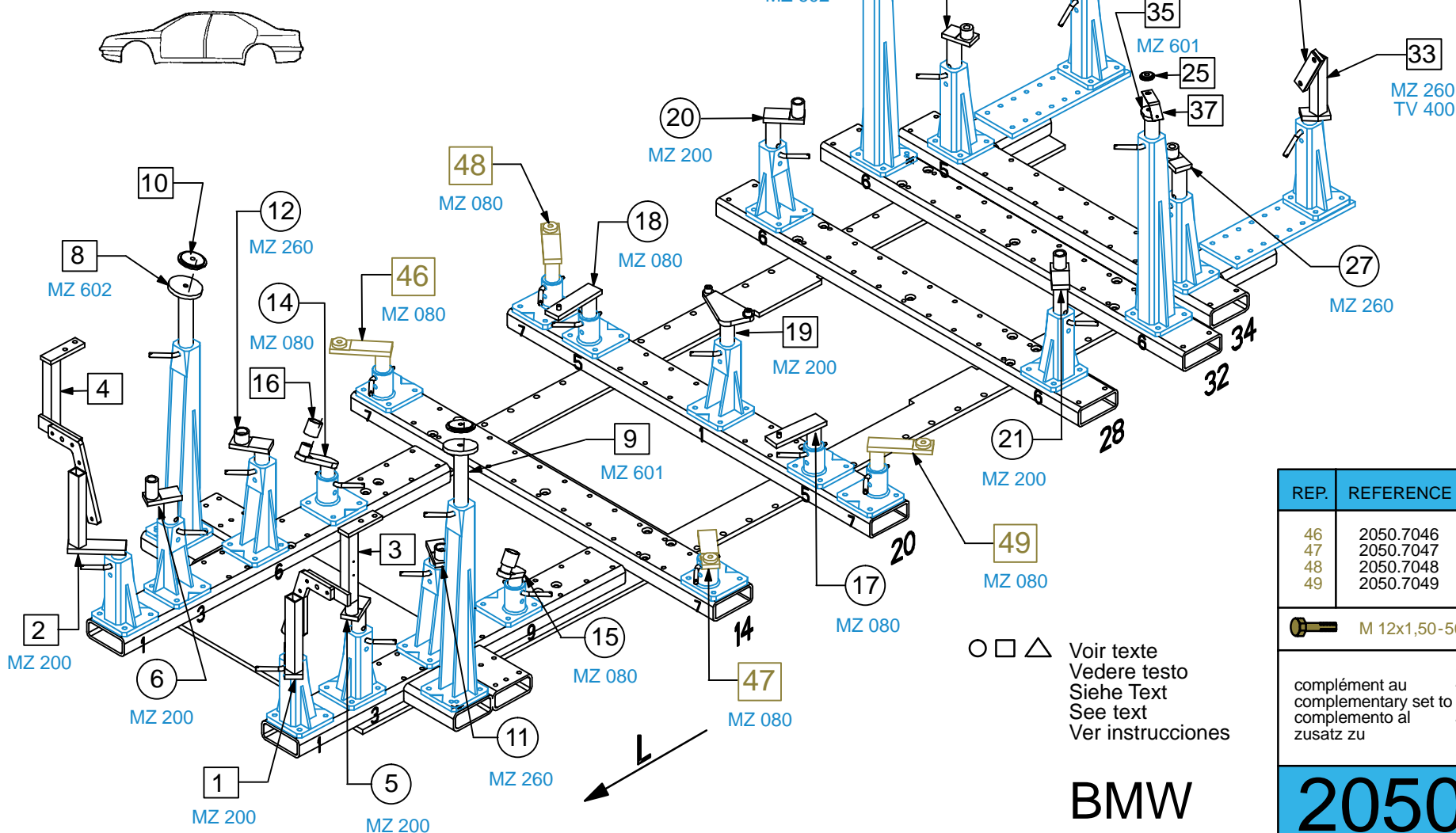

○ □ △ Voir texte  
Vedere testo  
Siehe Text  
See text  
Ver instrucciones

REP.	REFERENCE	PDS	NB	MZ
46	2050.7046	2,2	1	080
47	2050.7047	2,2	1	080
48	2050.7048	2,3	1	080
49	2050.7049	2,3	1	080

M 12x1,50-50 4

complément au  
complementary set to  
complemento al  
zusatz zu

**2050.310 +**  
**2050.309 +**  
**2050.308**

**2050.307**

9 Kg 09.04.2008 406-D-23F

**BMW**

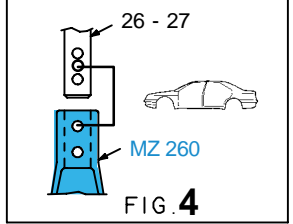
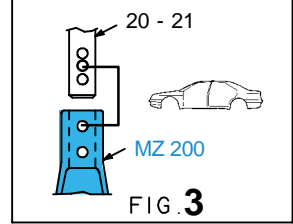
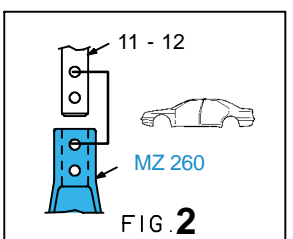
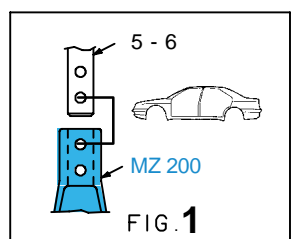
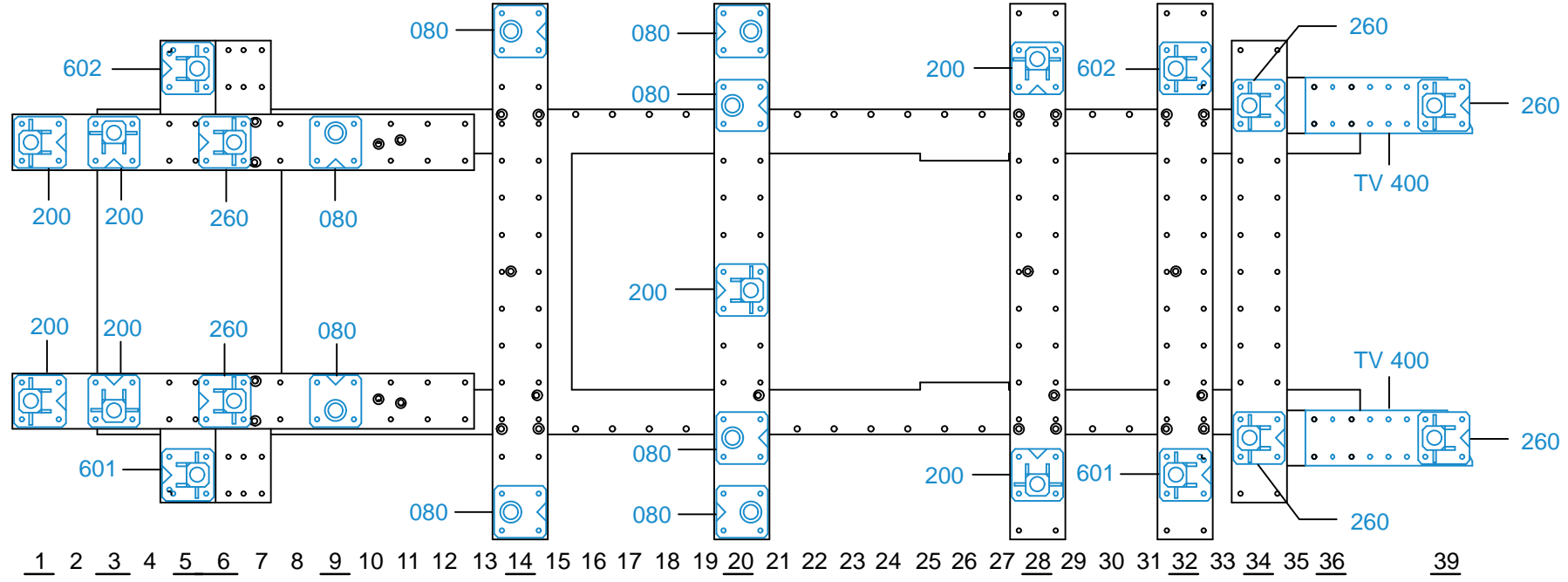

REP.	MOD.
35 - 36 + 25	
35 - 36 + 37 + 25	

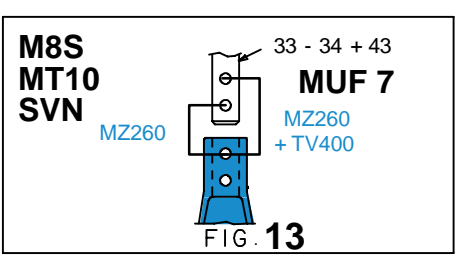
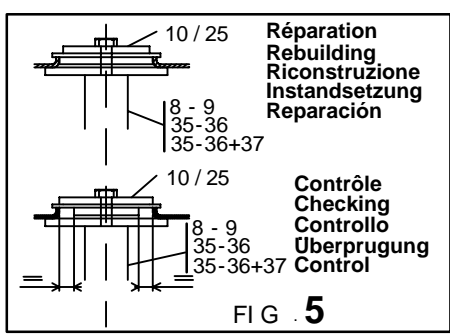

2050.307-RA3-1 00