

ANCRAGE DU VEHICULE
ANCHORING OF THE VEHICLE
VERANKERUNG DES FAHRZEUGS
ANCORAGGIO DEL VEICOLO
ANCLAJE DEL VEHICULO

AN.27.B + AN27.03

Ou/Or/Oder/O

AN.34

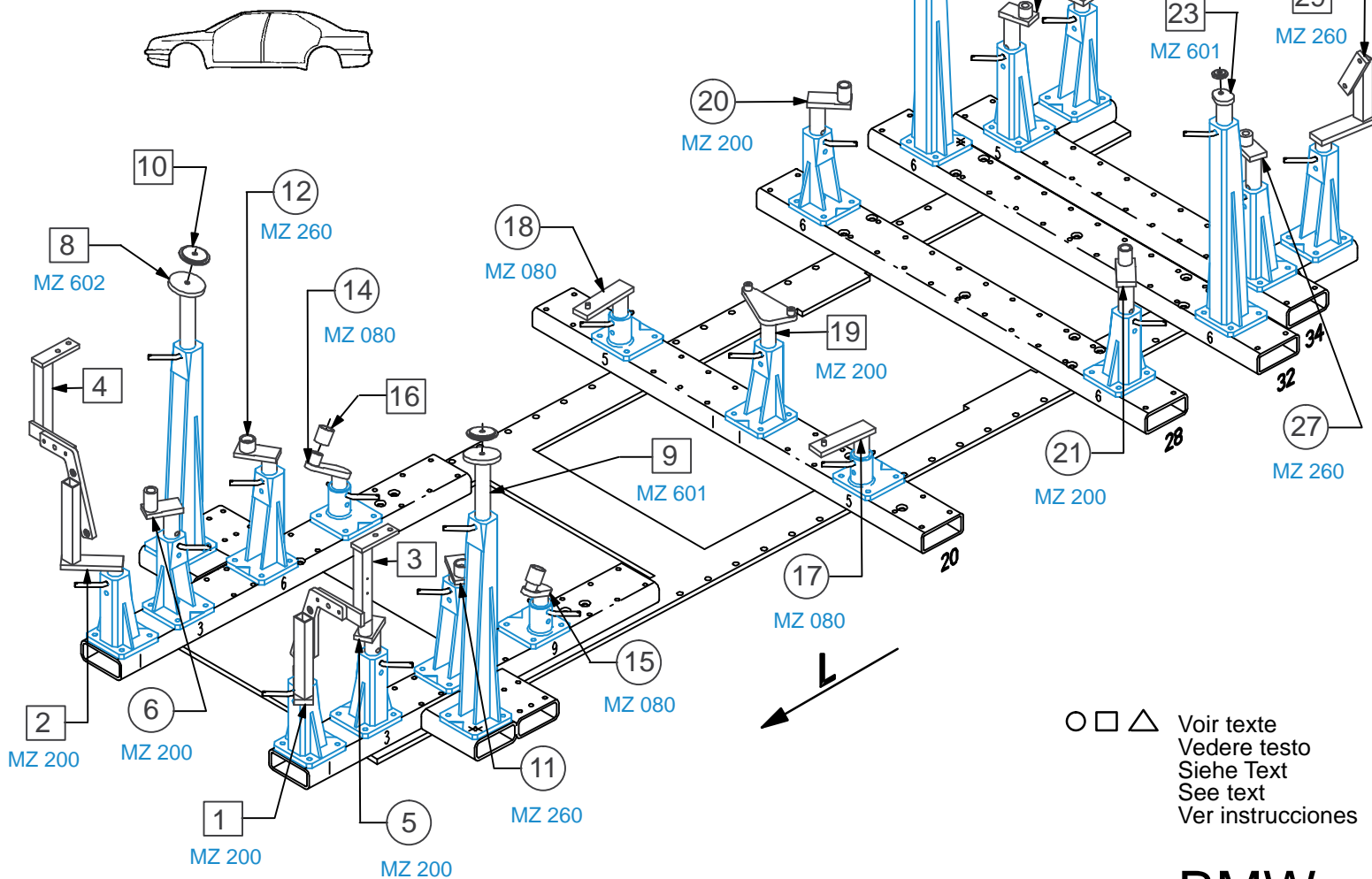

○ □ △ Voir texte
Vedere testo
Siehe Text
See text
Ver instrucciones

REP.	REFERENCE	PDS	NB	MZ
1	2050.7001	4,3	1	200
2	2050.7002	4,3	1	200
3	2050.7003	1,6	1	
4	2050.7004	1,6	1	
5	2050.7005	2,1	1	200/080
6	2050.7006	2,1	1	200/080
7	2050.7007	0,5	2	
8	2050.7008	1,8	1	602
9	2050.7009	1,8	1	601
10	2050.7010	0,4	2	
11	2050.7011	2,0	1	260/080
12	2050.7012	2,0	1	260/080
13	2050.7013	0,2	2	
14	2050.7014	1,7	1	080
15	2050.7015	1,7	1	080
16	2050.7016	0,2	2	
17	2050.7017	2,2	1	080
18	2050.7018	2,2	1	080
19	2050.7019	2,7	1	200
20	2050.7020	2,3	1	200/140
21	2050.7021	2,3	1	200/140
22	2050.7022	0,05	2	
23	2050.7023	0,9	1	601
24	2050.7024	0,9	1	602
25	2050.7025	0,07	2	
26	2050.7026	2,1	1	260/200
27	2050.7027	2,1	1	260/200
28	2050.7028	3,0	1	260
29	2050.7029	3,0	1	260
30	2050.7030	1,0	1	

M 8-40	2
M 12-25	2
M 12-30	2
M 12-35	2
M 12-45	2
M 12-60	4
M 12-80	2
M 12x1,50-60	2
M 12x1,50-70	2
M 12x1,50-80	4
M 12x1,50-90	2
M 12x1,50-150	2
M 12x1,50-160	2
M 8	4
M 12	8

BMW

2050.300

56 Kg | 28.02.2005 | 406-D-23A

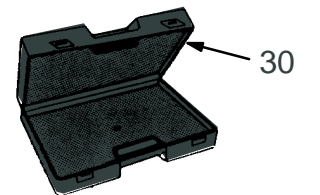
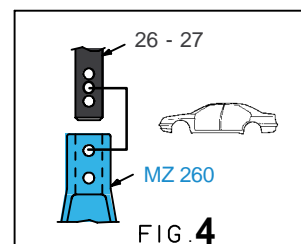
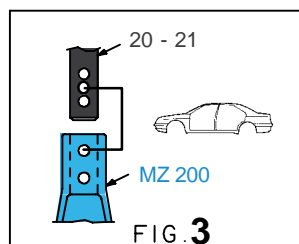
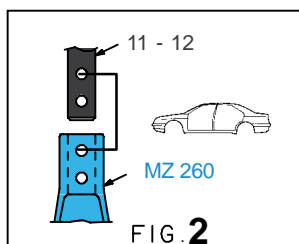
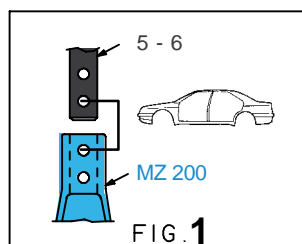
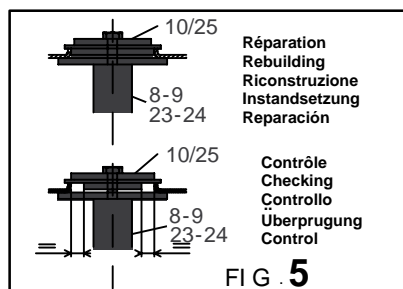
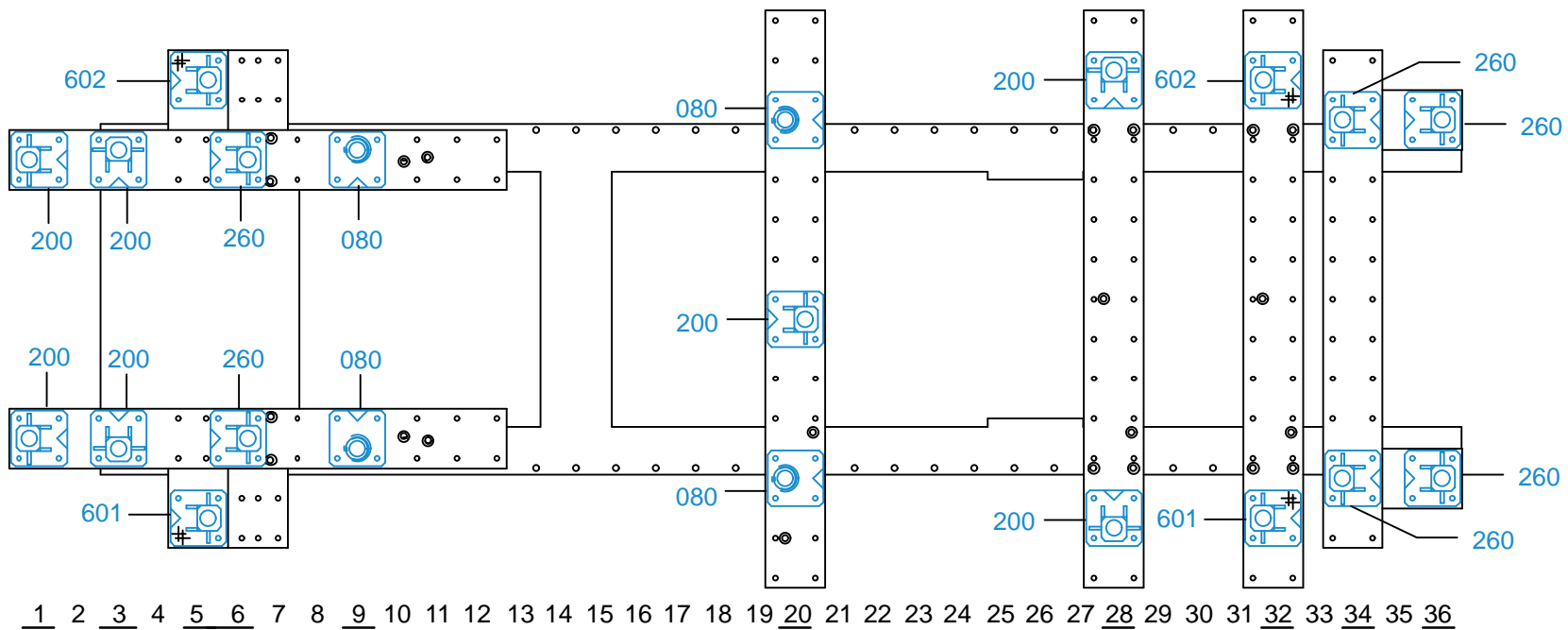

2050.300-RVA3-1 | 01

ANCRAGE DU VEHICULE
ANCHORING OF THE VEHICLE
VERANKERUNG DES FAHRZEUGS
ANCORAGGIO DEL VEICOLO
ANCLAJE DEL VEHICULO

AN.27.B + AN27.03

Ou/Or/Oder/O

AN.34

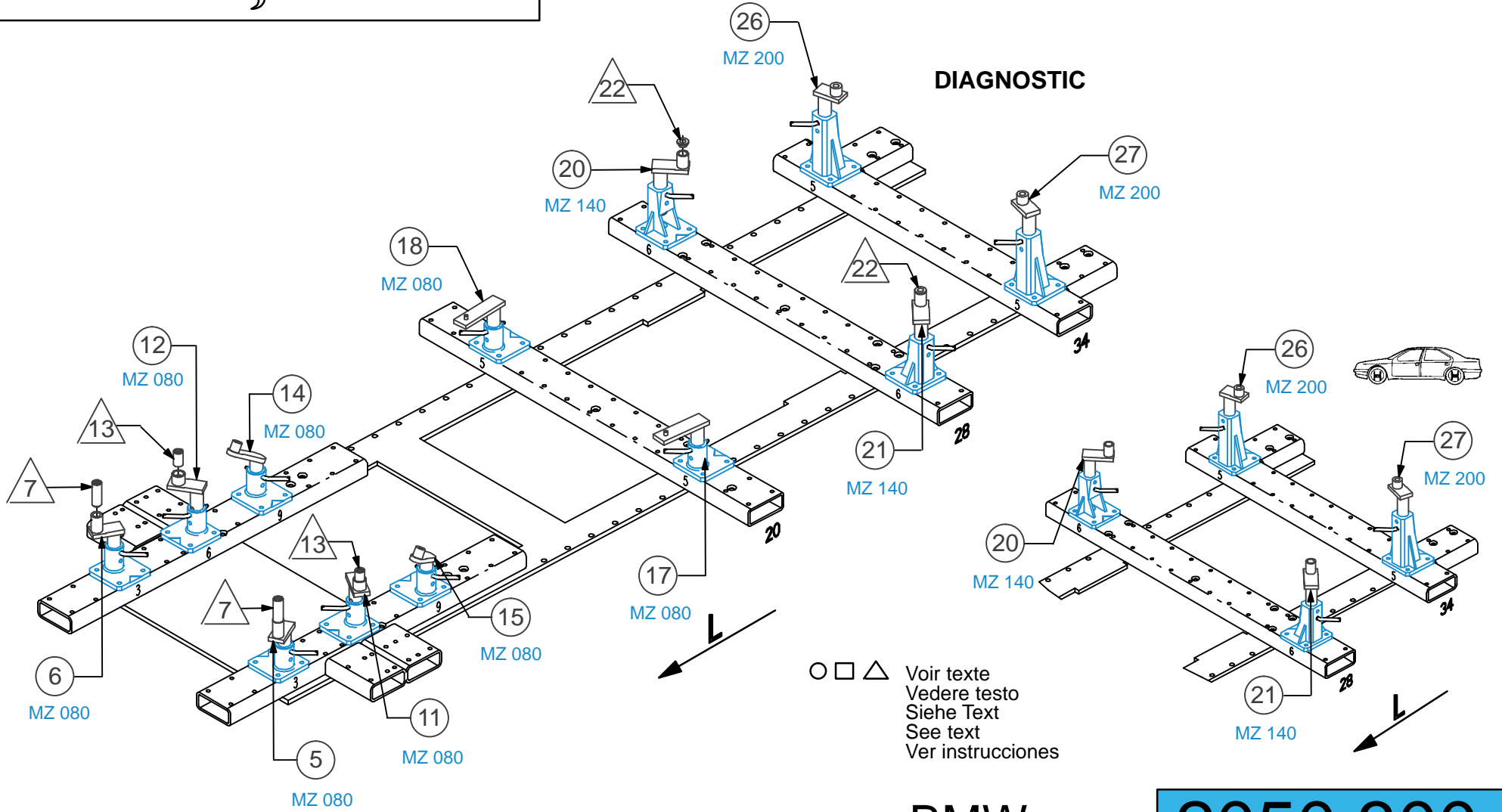

BMW

2050.300

56 Kg | 01.07.2004 | 406-D-23B

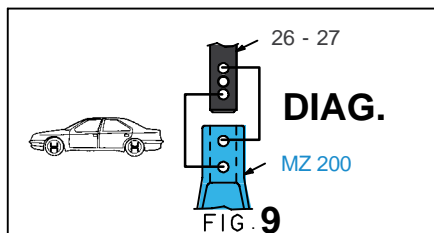
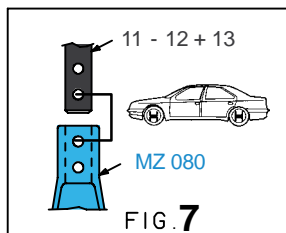
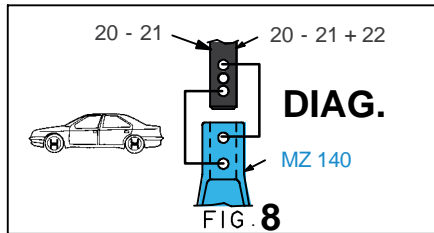
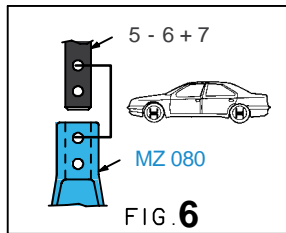
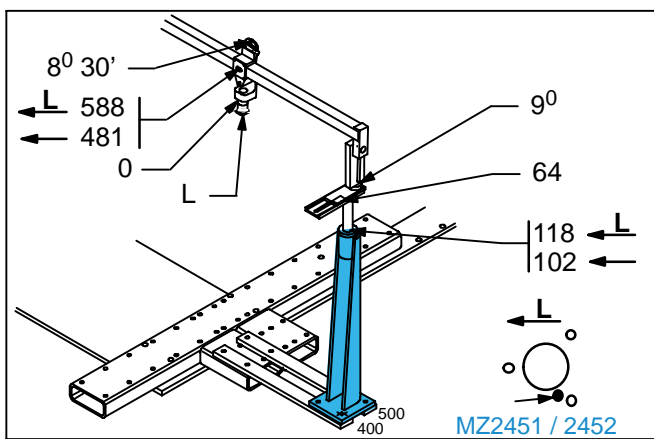
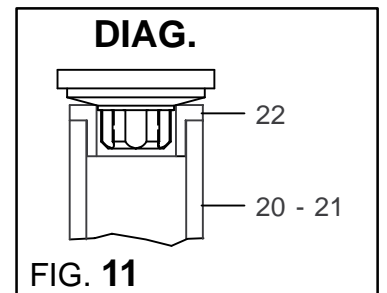
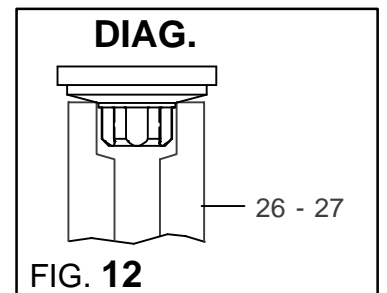
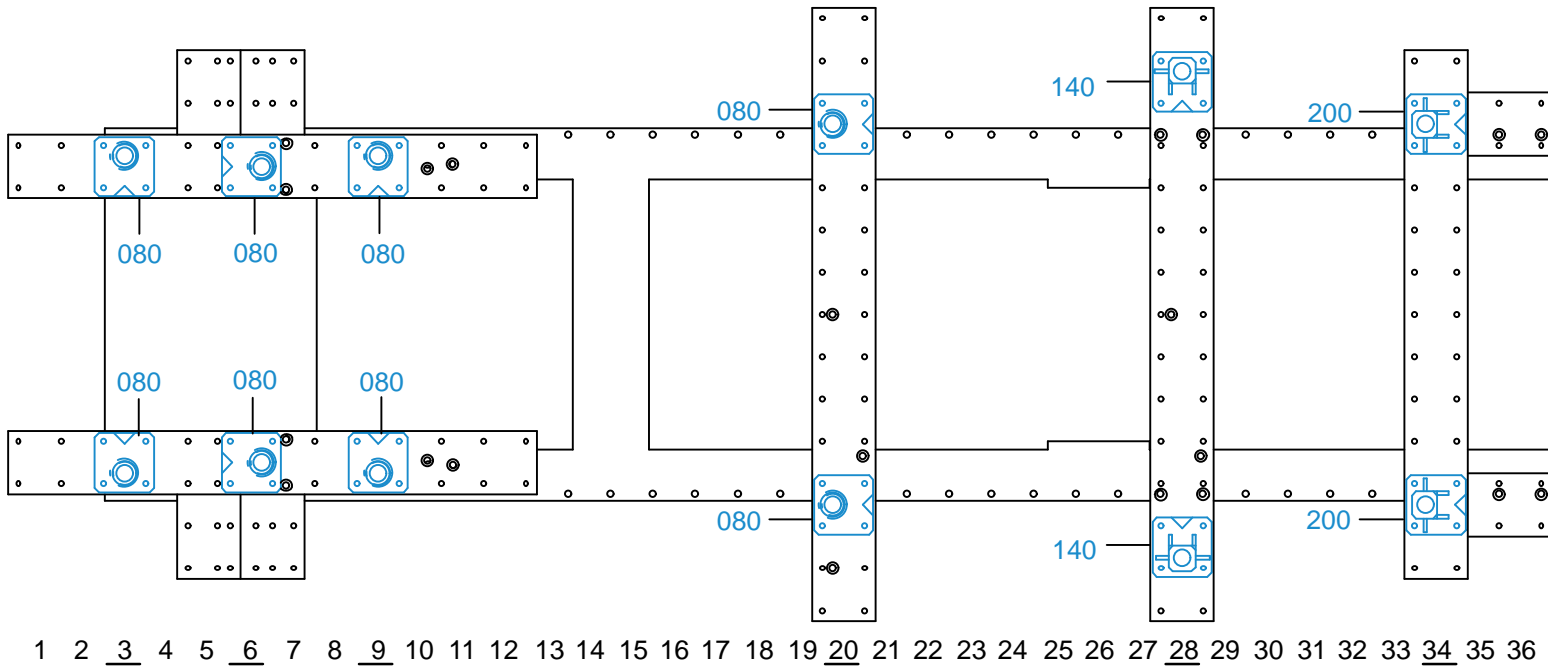

2050.300-RVA3-1 | 01