

○ Avec ou sans mécanique
 With or without mechanical elements
 Con o senza parti meccaniche
 Mit oder ohne Aggregate
 Con ó sin mecanica desmontada

REP.	REFERENCE	PDS	NB	MZ
1	2046.7001	1,2	1	140
2	2046.7002	1,2	1	140
3	2046.7003	2,7	1	141
4	2046.7004	2,7	1	142
5	2046.7005	1,9	1	601
6	2046.7006	1,9	1	602
7	2046.7007	0,8	2	
8	2046.7008	1,8	1	140/080
9	2046.7009	1,8	1	140/080
10	2046.7010	1,9	1	080
11	2046.7011	1,9	1	080
12	2046.7012	2,7	1	080
13	2046.7013	2,7	1	080
14	2046.7014	0,9	1	
15	2046.7015	0,9	1	
16	2046.7016	0,9	1	
17	2046.7017	0,9	1	
18	2046.7018	2,5	1	260
19	2046.7019	2,5	1	260
20	2046.7020	2,4	1	260/200
21	2046.7021	2,4	1	260/200
22	2046.7022	2,0	1	200
23	2046.7023	2,2	1	200
	E22	0,1	2	
	V32	0,1	2	

M 10-16	6
M 12-25	8
M 12x1,25-60	2
M 14x1,50-50	2
M 14x1,50-70	2
M 14x1,50-130	2
M 14x1,50-150	2
MU 12	2
M 12x1,50	2

TOYOTA

2046.300

45 Kg 13.05.2004 434-D-80A

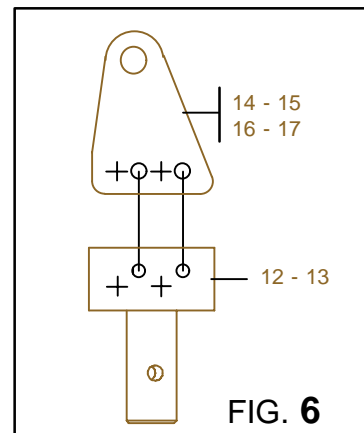
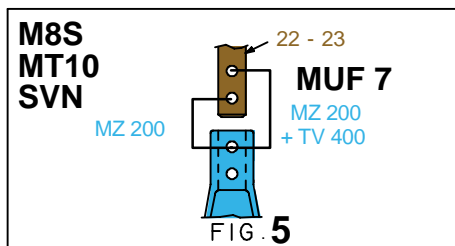
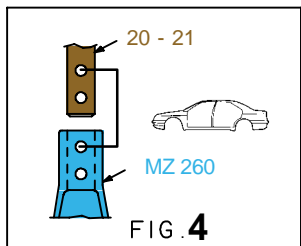
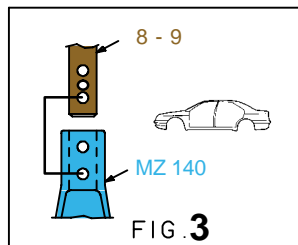
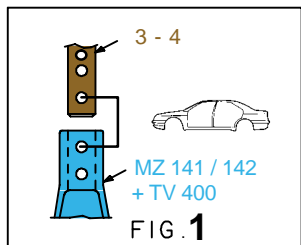
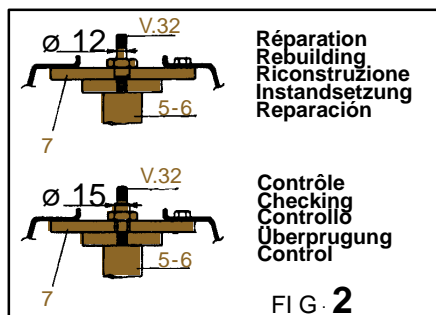
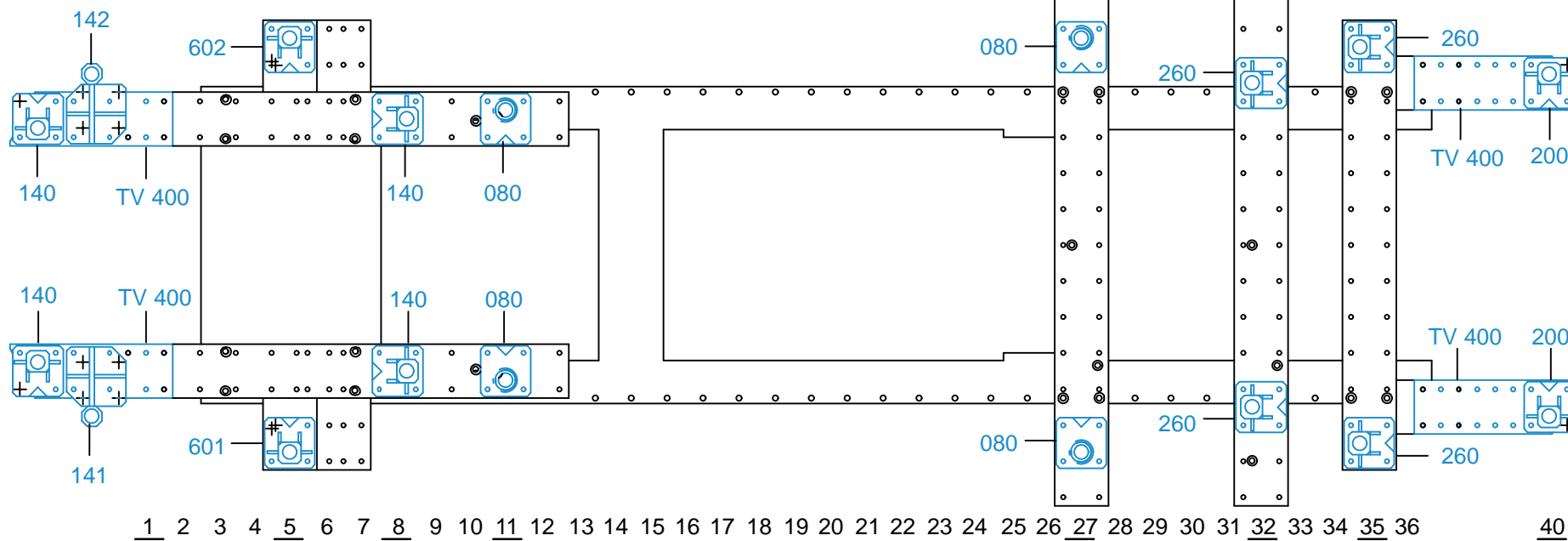

2046.300-RVA3-1 00

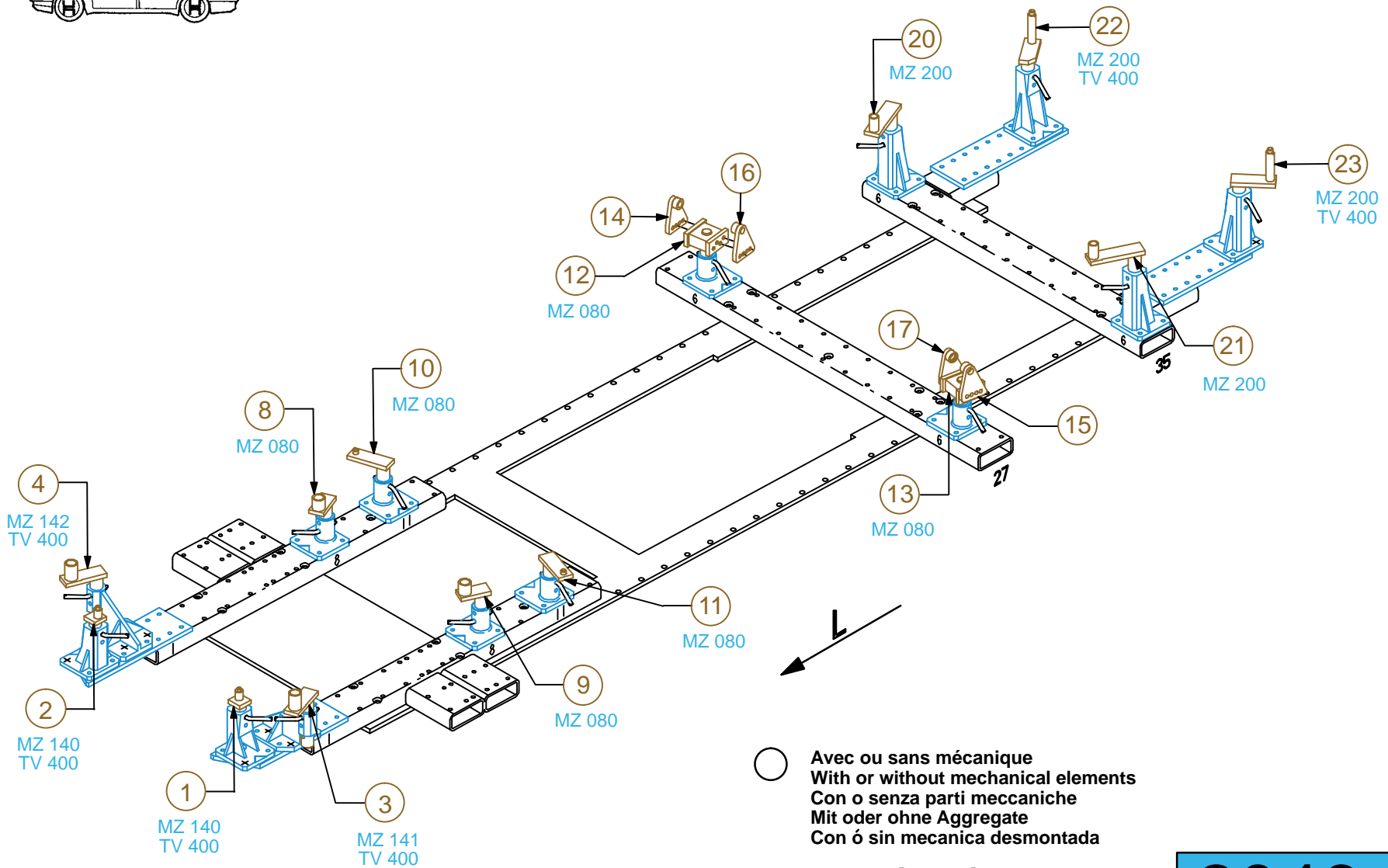
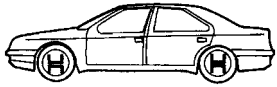

TOYOTA

2046.300

45 Kg	13.05.2004	434-D-80B
-------	------------	-----------

