

REFERENCE	NB
CHc TB 12-25	32
MU 12	2
M 8	6

○ Avec ou sans mécanique
 With or without mechanical elements
 Con o senza parti meccaniche
 Mit oder ohne Aggregate
 Con ó sin mecanica desmontada

REP.	REFERENCE	PDS	NB	MZ
1	2043.7001	3,0	1	260
2	2043.7002	3,0	1	260
3	2043.7003	1,7	1	260/080
4	2043.7004	1,7	1	260/080
5	2043.7005	0,3	2	
6	2043.7006	2,6	1	602
7	2043.7007	2,6	1	601
8	2043.7008	2,8	1	
9	2043.7009	2,8	1	
10	2043.7010	0,1	4	
11	2043.7011	0,1	2	
12	2043.7012	0,8	1	
13	2043.7013	0,8	1	
14	2043.7014	3,9	1	
15	2043.7015	1,0	2	
16	2043.7016	1,7	1	140/080
17	2043.7017	1,7	1	140/080
18	2043.7018	0,1	6	
19	2043.7019	7,0	1	
20	2043.7020	7,0	1	
21	2043.7021	0,8	2	
22	2043.7022	2,2	1	080
23	2043.7023	2,5	1	080
24	2043.7024	2,4	1	200
25	2043.7025	2,2	1	080
26	2043.7026	2,2	1	080
27	2043.7027	2,0	1	200/140
28	2043.7028	2,0	1	200/140
29	2043.7029	2,8	1	601
30	2043.7030	2,8	1	602
31	2043.7031	1,5	2	
32	2043.7032	2,9	1	142
33	2043.7033	2,9	1	141
34	2043.7034	0,5	2	
35	2043.7035	2,7	1	260
36	2043.7036	2,7	1	260
37	2043.7037	2,4	1	
38	2043.7038	2,3	1	
39	2043.7039	2,5	8	
40	2043.7040	2,7	1	
41	2043.7041	2,7	1	
	V32	0,1	2	
	B76	0,1	6	

M 8-25	2
M 8-30	8
M 8-45	4
M 10-30	2
M 10-80	4
M 12-25	38
M 12-40	2
M 14-20	2
M 14x1,50-40	4
M 14x1,50-60	2
M 14x1,50-110	2
M 14x1,50-130	2
M 14x1,50-140	2

BENTLEY

2043.310

119 Kg 09.06.2006 462-D-1E

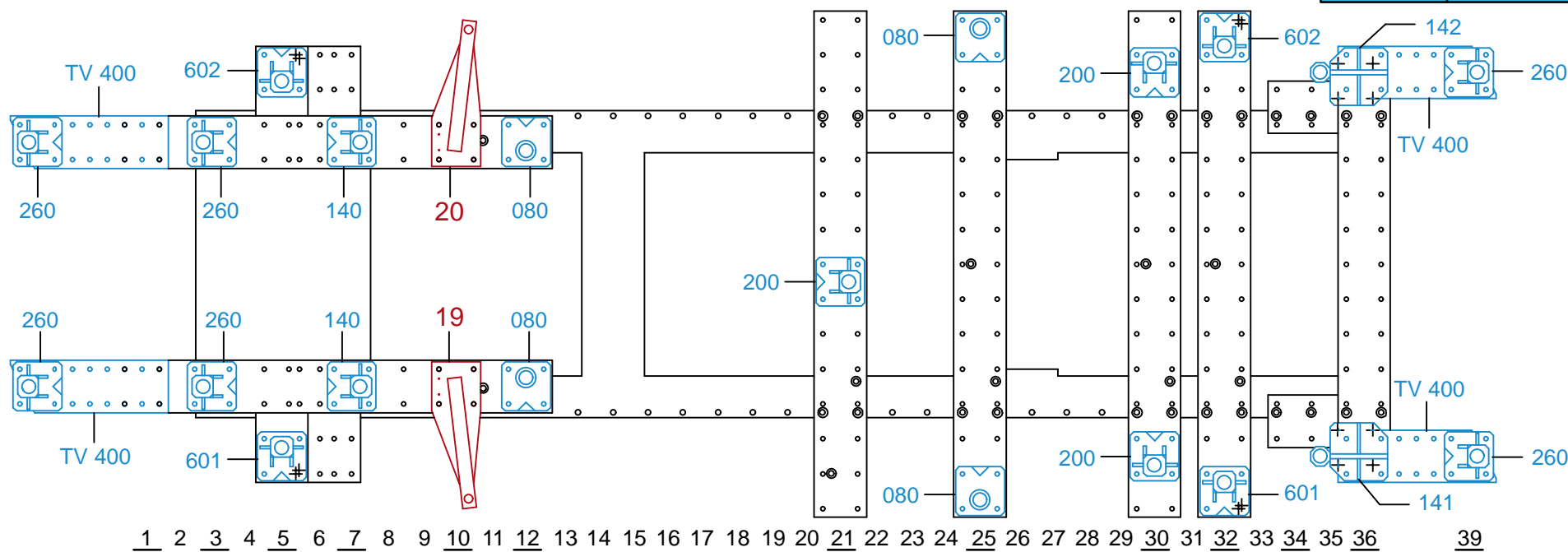

1 2 3 4 5 6 7 8 9 10 11 12 13 14 15 16 17 18 19 20 21 22 23 24 25 26 27 28 29 30 31 32 33 34 35 36 39

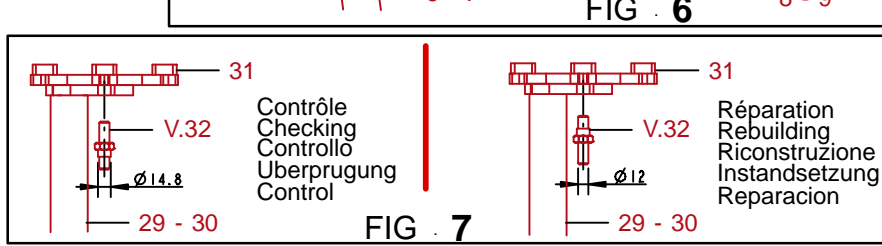
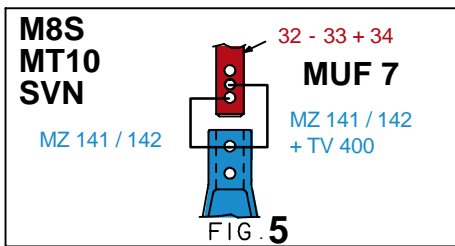
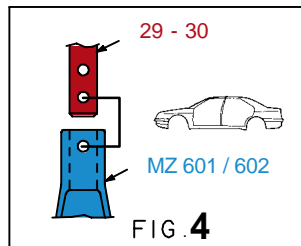
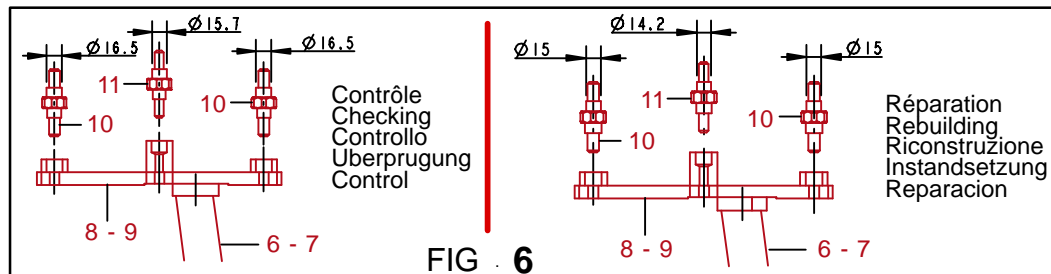
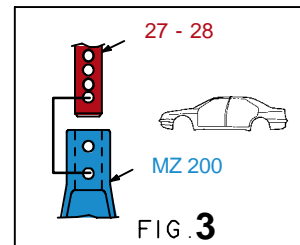
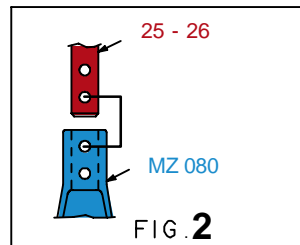
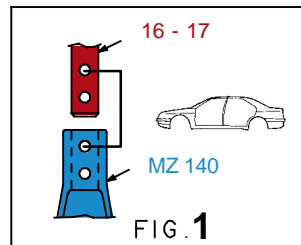

2043.310-RVA3-1 00

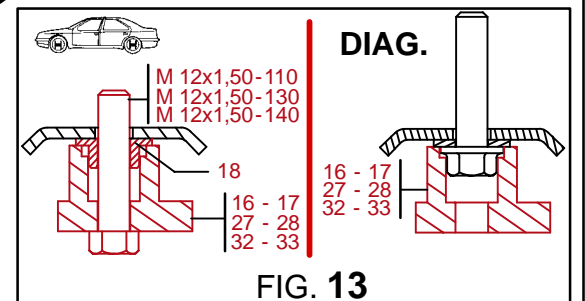
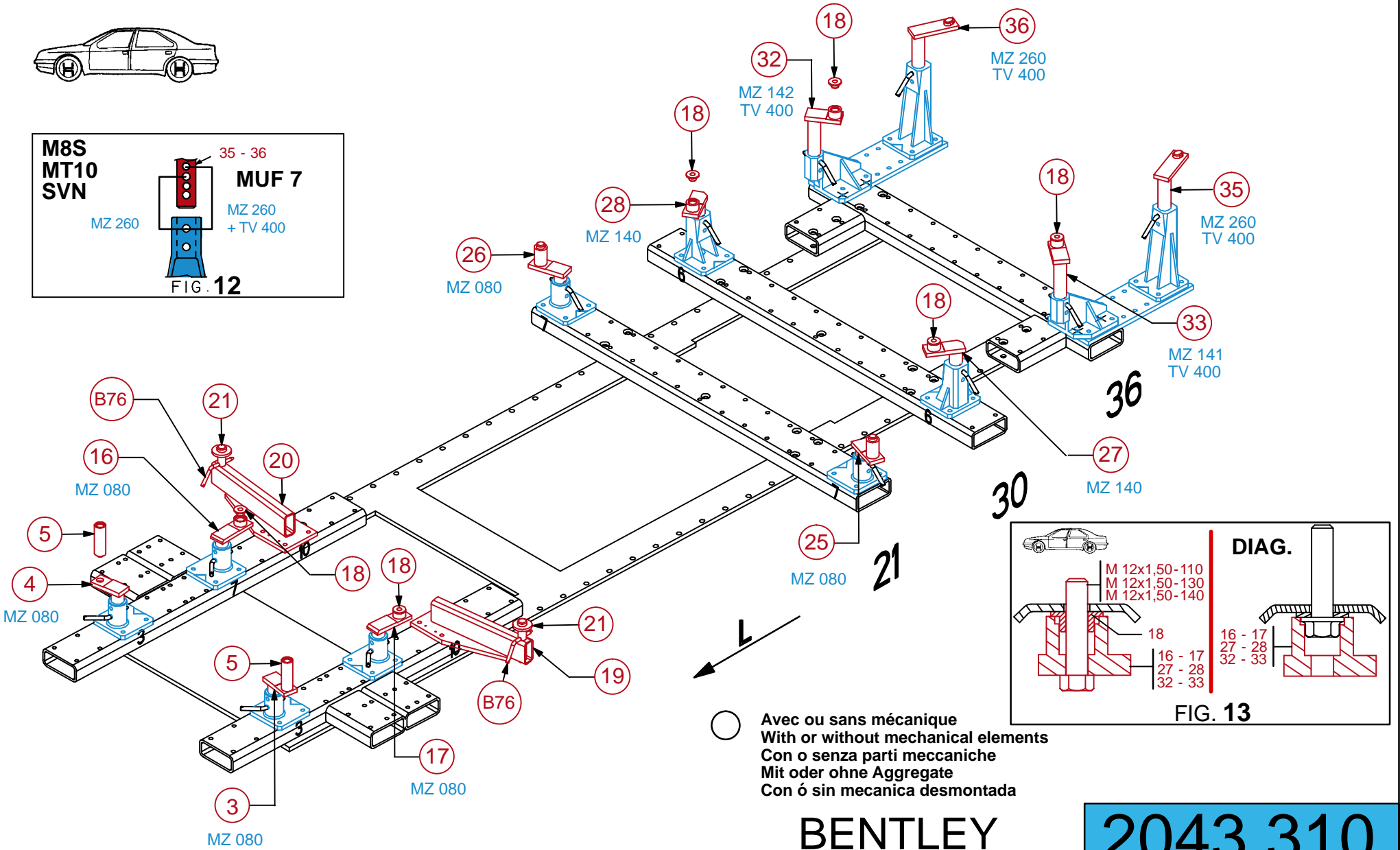
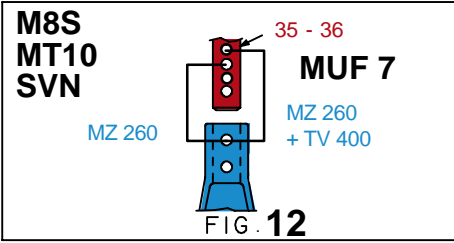
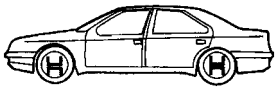

○ Avec ou sans mécanique
With or without mechanical elements
Con o senza parti meccaniche
Mit oder ohne Aggregate
Con ó sin mecanica desmontada

BENTLEY

2043.310

119 Kg	09.06.2006	462-D-1F
--------	------------	----------

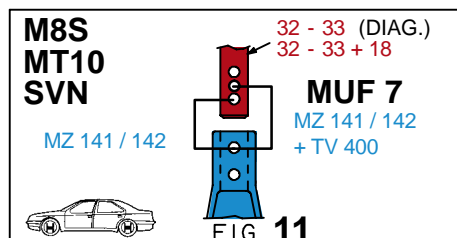
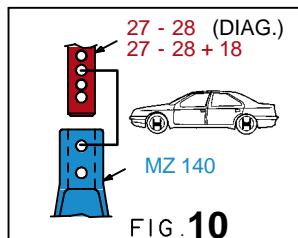
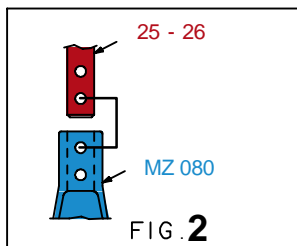
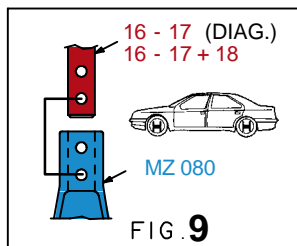
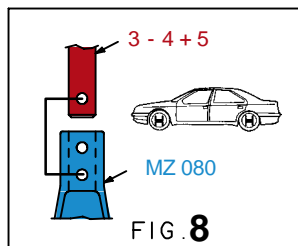
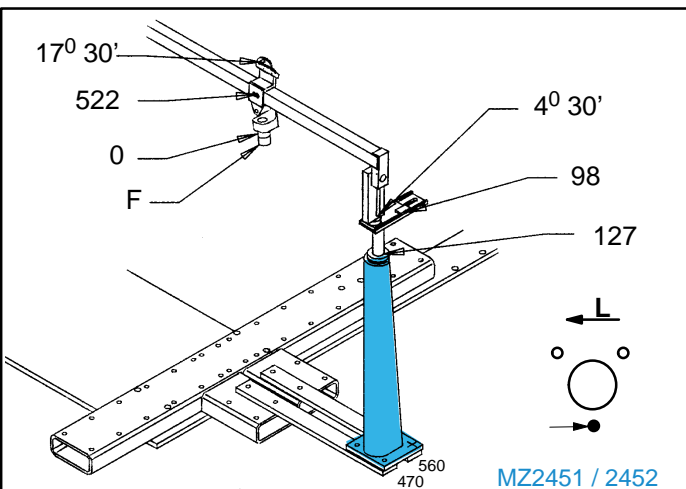
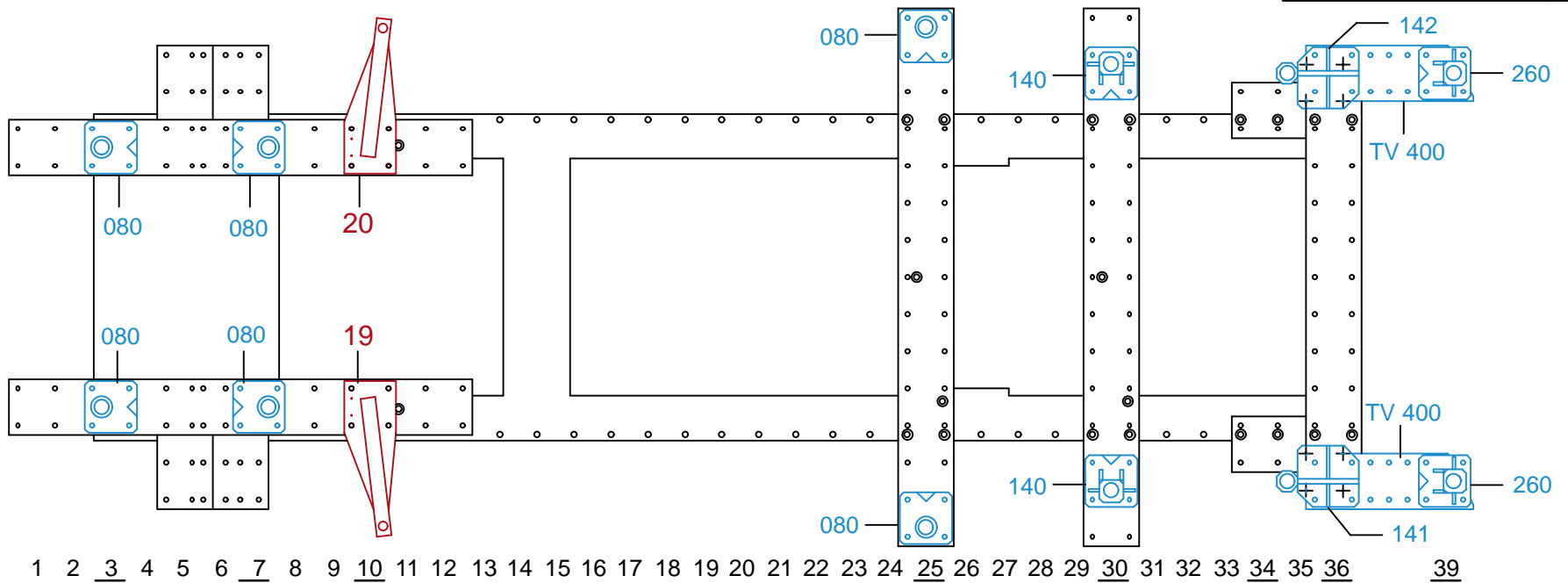



**M8S
MT10
SVN**

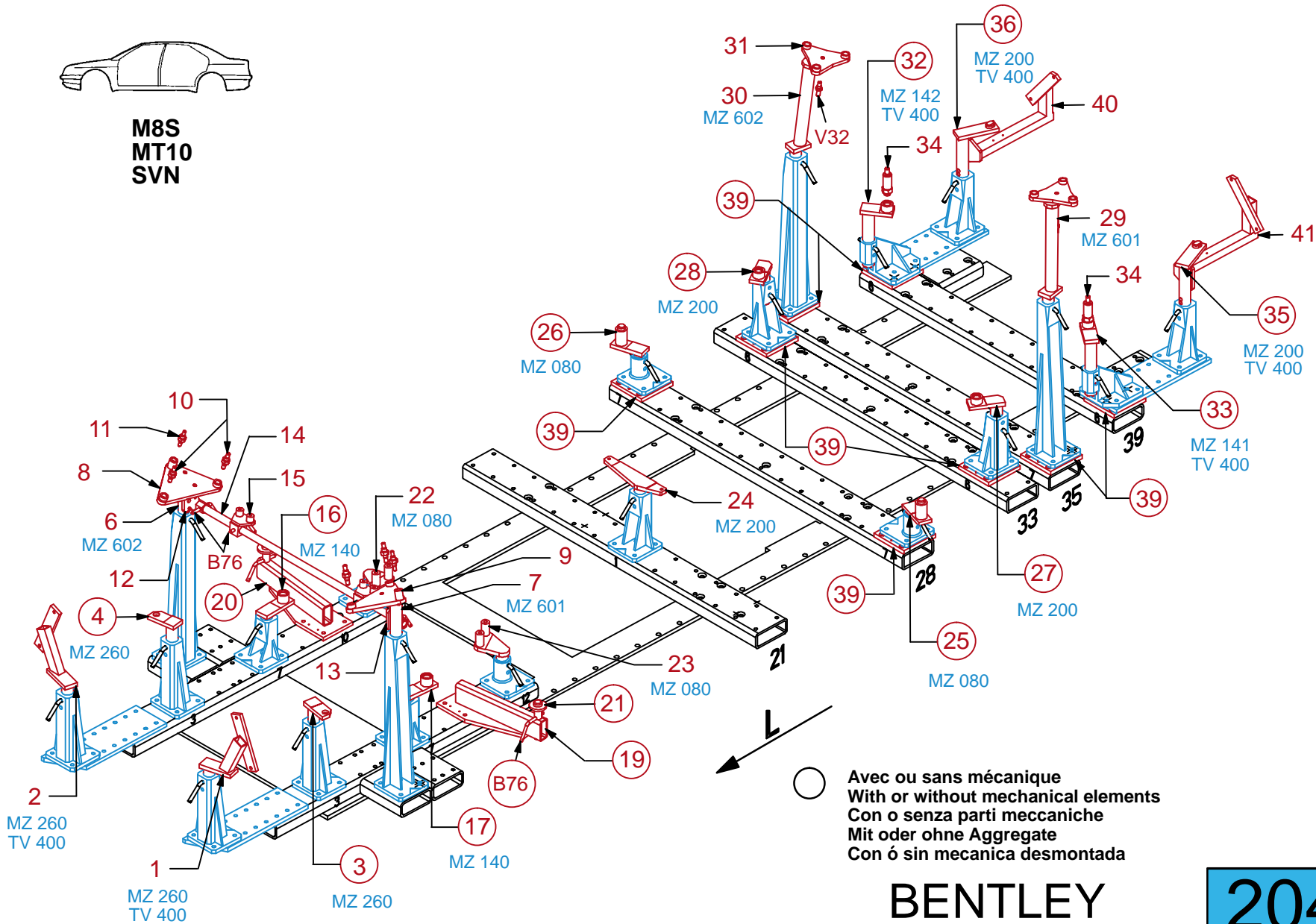

○ Avec ou sans mécanique
With or without mechanical elements
Con o senza parti meccaniche
Mit oder ohne Aggregate
Con ó sin mecanica desmontada

BENTLEY

2043.310

119 Kg	04.03.2005	462-D-1G
--------	------------	----------

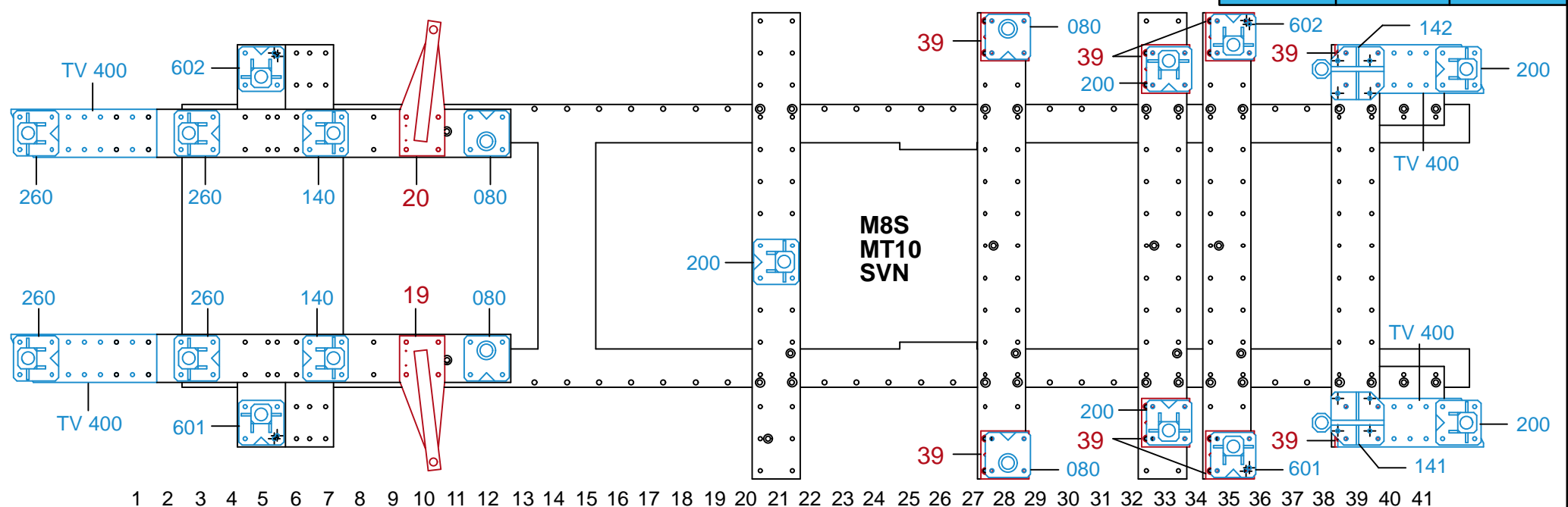

- 1 2 3 4 5 6 7 8 9 10 11 12 13 14 15 16 17 18 19 20 21 22 23 24 25 26 27 28 29 30 31 32 33 34 35 36 37 38 39 40 41

<p>16 - 17</p> <p>MZ 140</p> <p>FIG. 1</p>	<p>25 - 26</p> <p>MZ 080 + 39</p> <p>FIG. 14</p>	<p>27 - 28</p> <p>MZ 200 + 39</p> <p>FIG. 15</p>	<p>8 - 9</p> <p>FIG. 6</p>	<p>10 - 11</p> <p>FIG. 7</p>
<p>29 - 30</p> <p>MZ 601 / 602 + 39</p> <p>FIG. 16</p>	<p>32 - 33 + 34</p> <p>MZ 141 / 142 + TV 400 + 39</p> <p>FIG. 17</p>	<p>35 - 36</p> <p>MZ 200 + TV 400 + 39</p> <p>FIG. 18</p>	<p>8 - 9</p> <p>FIG. 6</p>	<p>29 - 30</p> <p>FIG. 7</p>

2043.310-RVA3-2 00

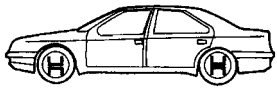

M8S
MT10
SVN

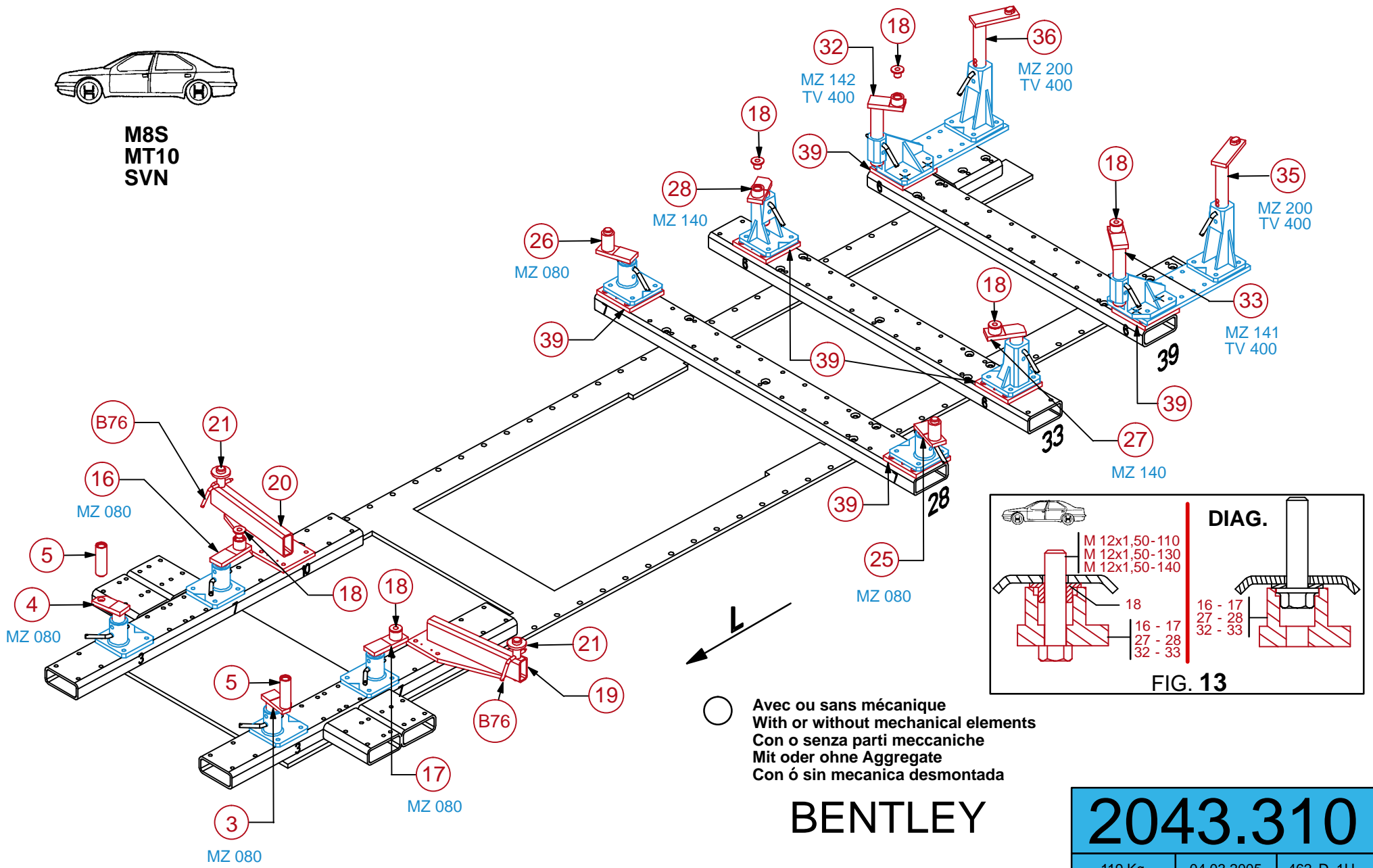

BENTLEY

2043.310

119 Kg | 04.03.2005 | 462-D-1H

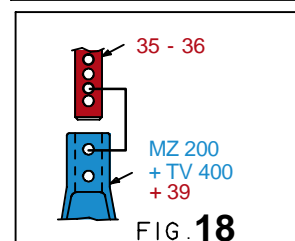
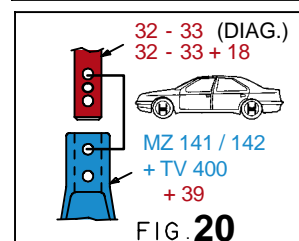
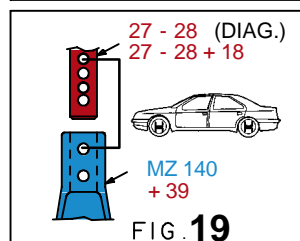
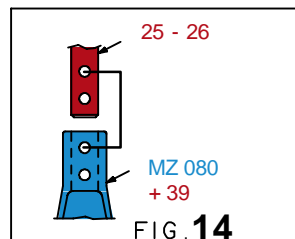
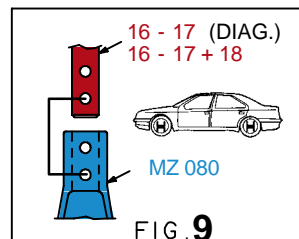
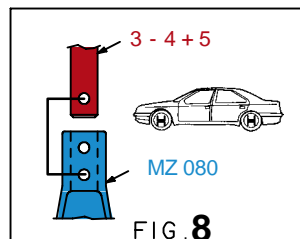
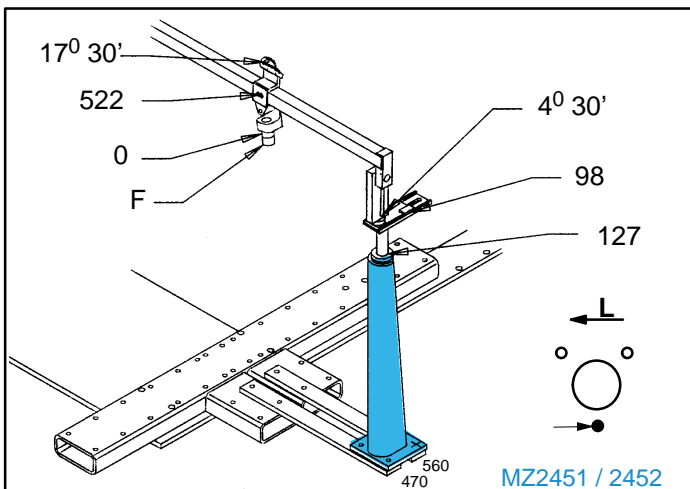
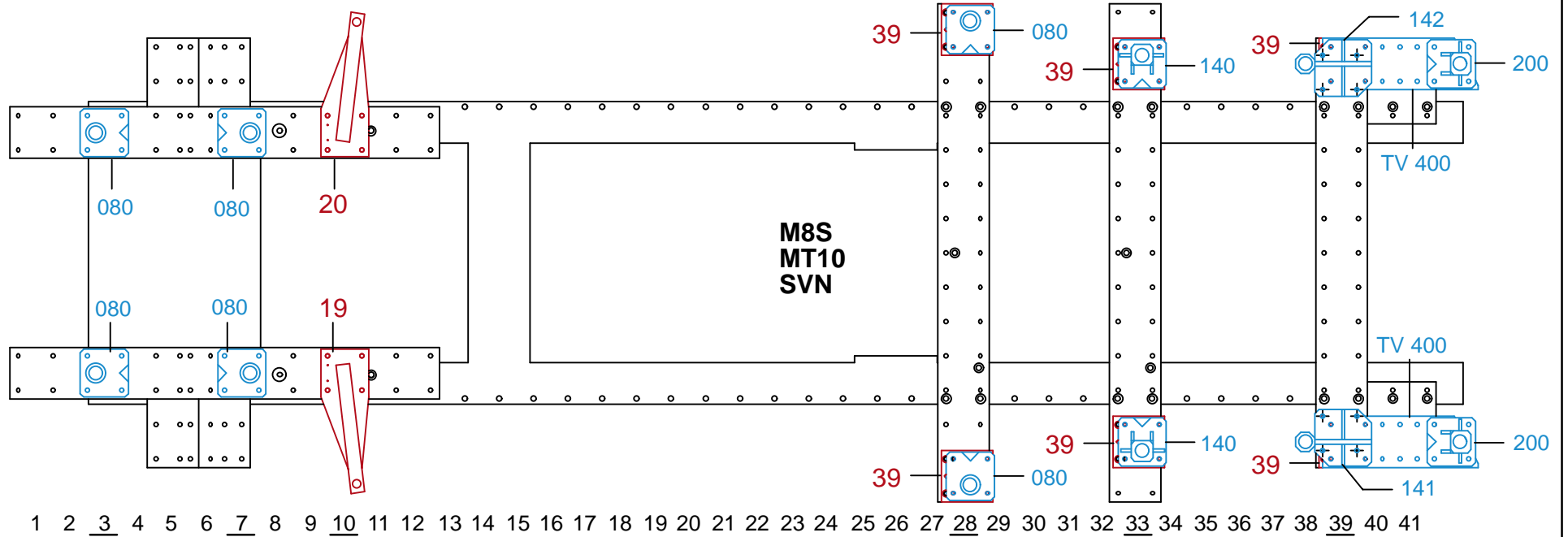

2043.310-RVA3-2 | 00