

**M8S
MT10
SVN**

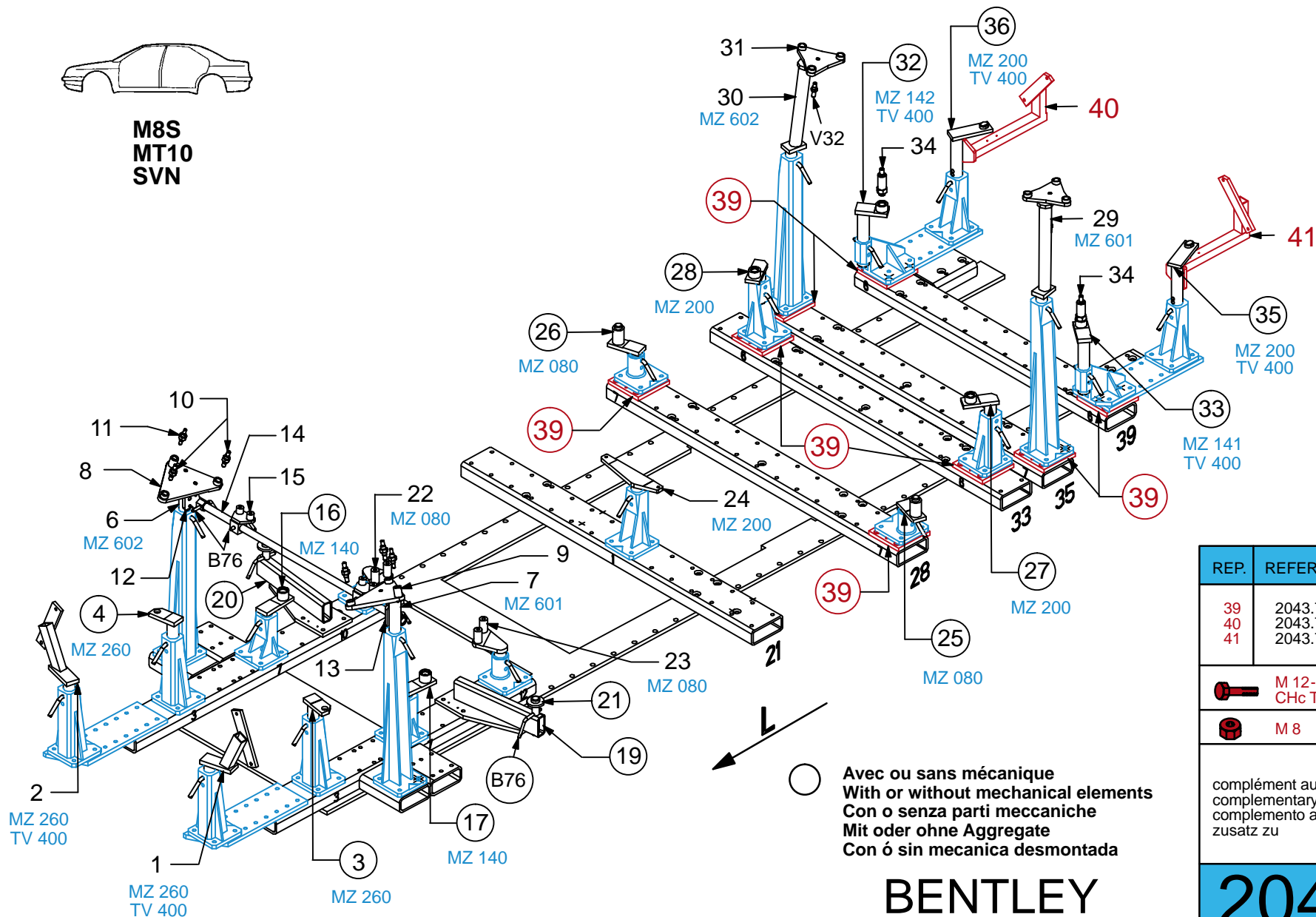

Avec ou sans mécanique
With or without mechanical elements
Con o senza parti meccaniche
Mit oder ohne Aggregate
Con ó sin mecanica desmontada

BENTLEY

REP.	REFERENCE	PDS	NB	MZ
39	2043.7039	2,5	8	
40	2043.7040	2,7	1	
41	2043.7041	2,7	1	

	M 12-25 CHc TB 12-25		34 32	
	M 8		4	

complément au
complementary set to
complemento al
zusatz zu

2043.300

2043.309

27 Kg 03.03.2005 462-D-1C

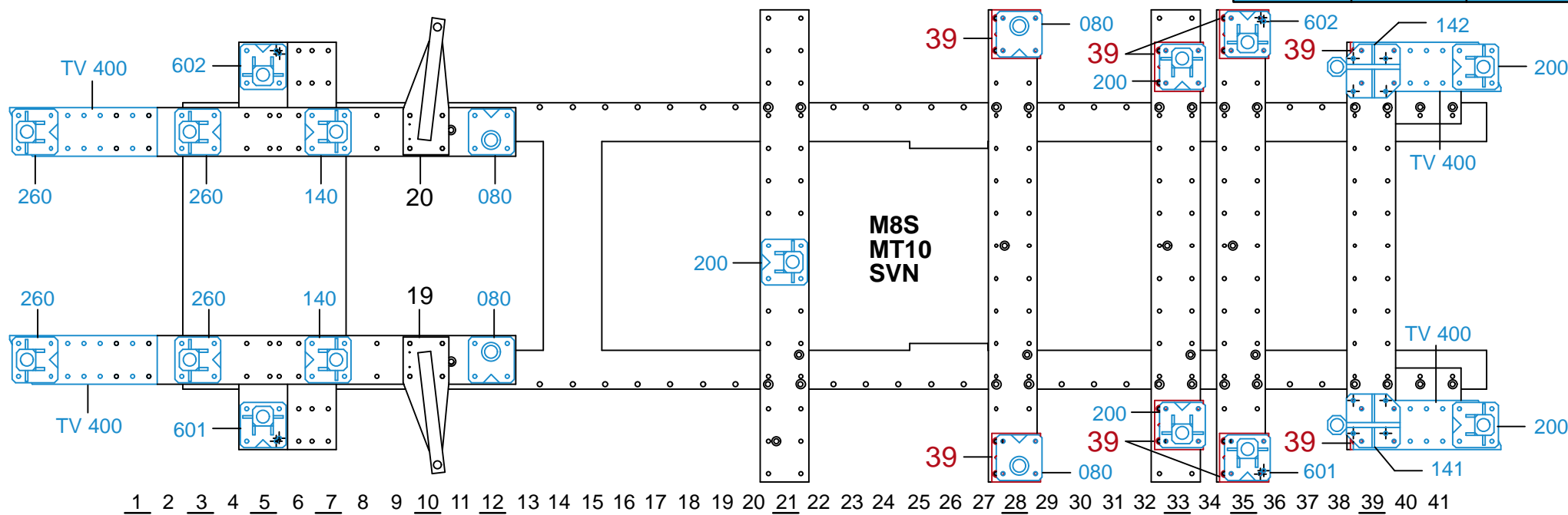

1 2 3 4 5 6 7 8 9 10 11 12 13 14 15 16 17 18 19 20 21 22 23 24 25 26 27 28 29 30 31 32 33 34 35 36 37 38 39 40 41

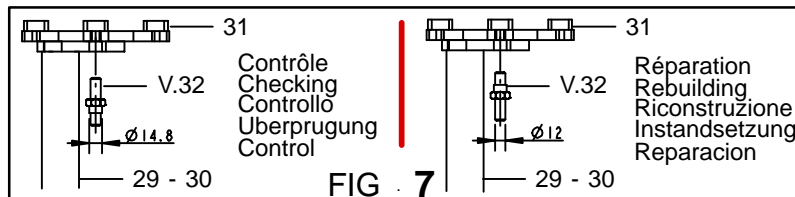
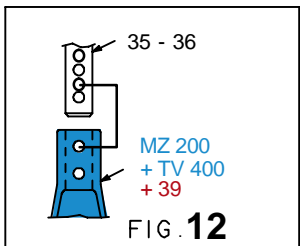
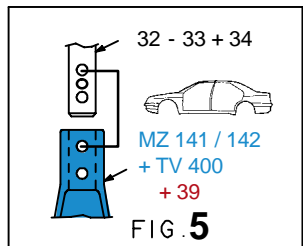
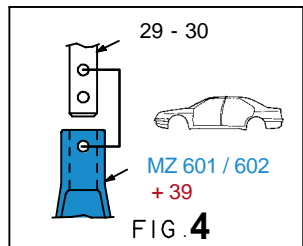
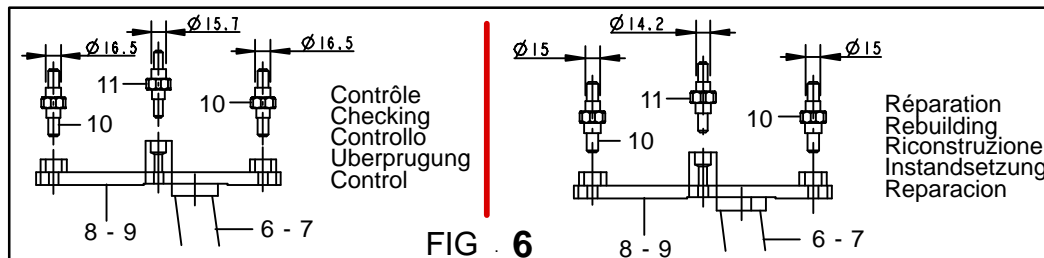
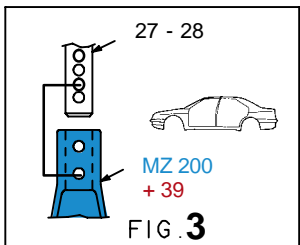
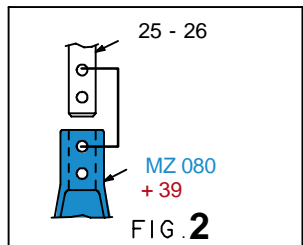
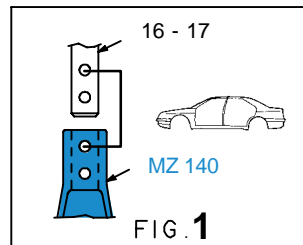

2043.309-RVA3-1 00

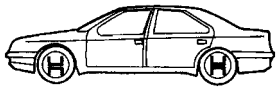

M8S
MT10
SVN

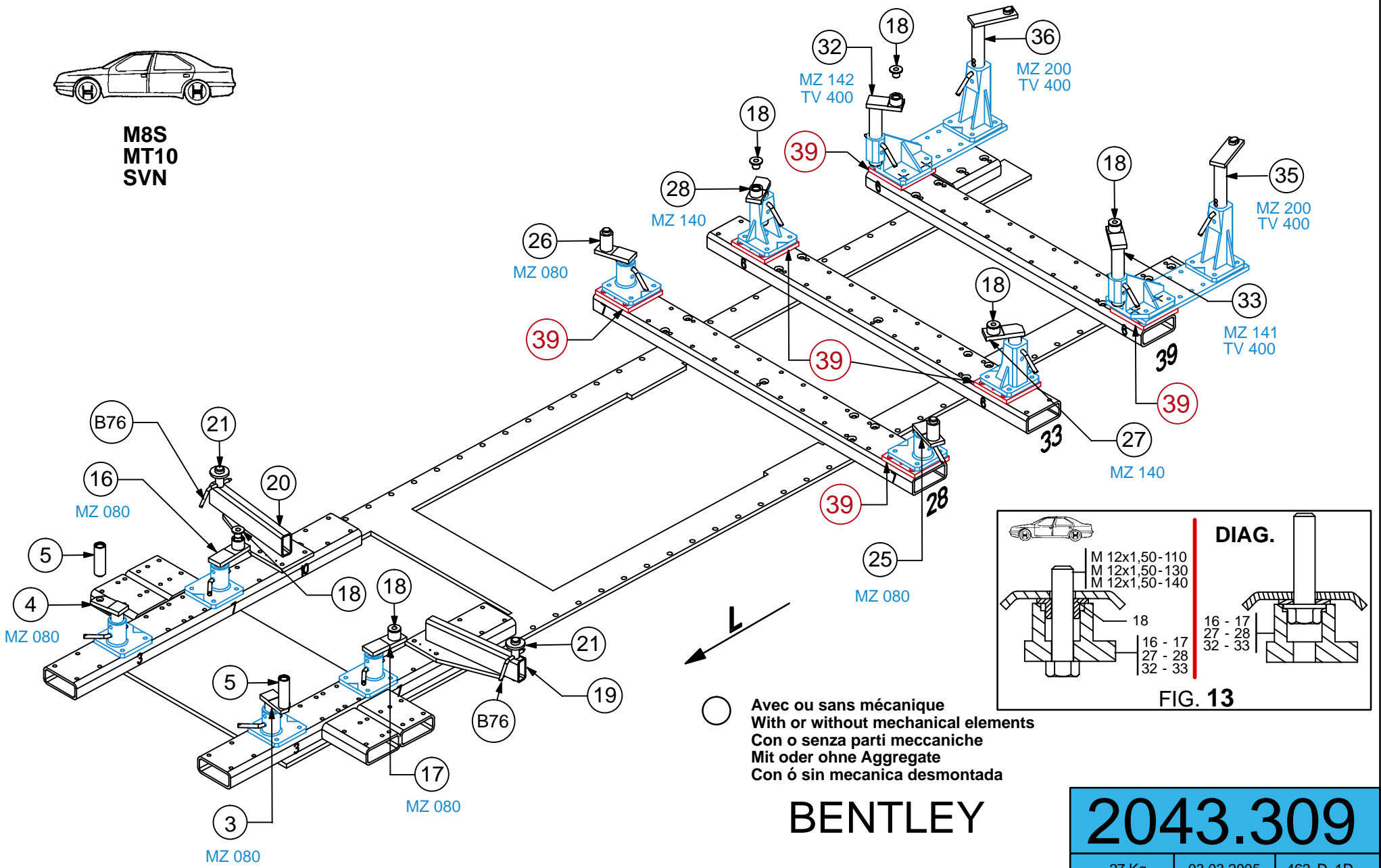

BENTLEY

2043.309

27 Kg | 03.03.2005 | 462-D-1D

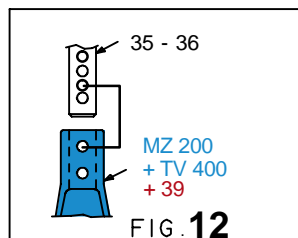
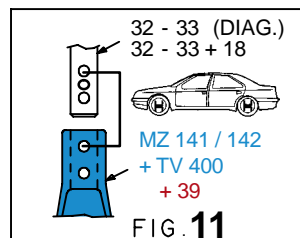
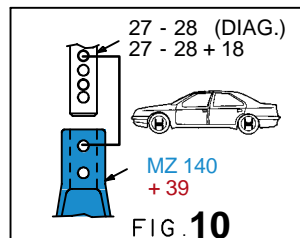
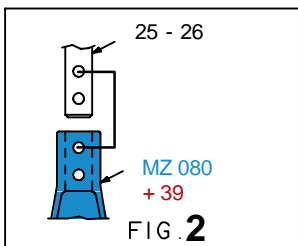
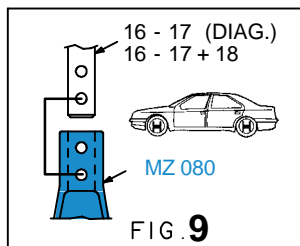
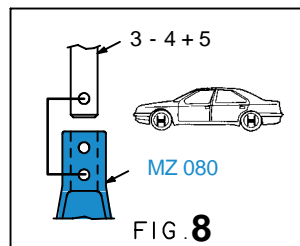
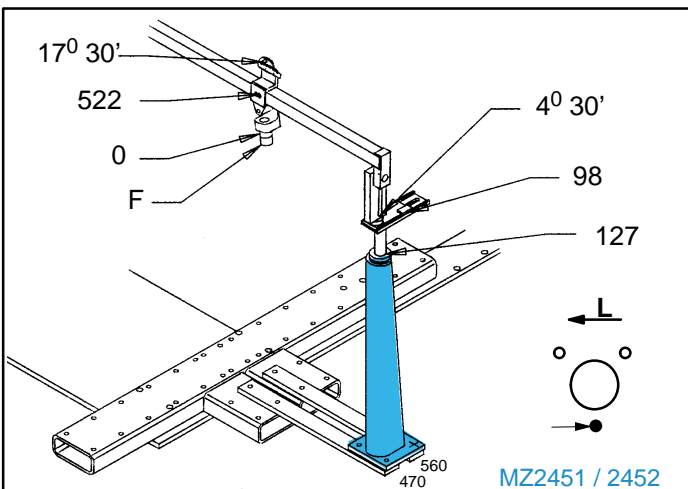
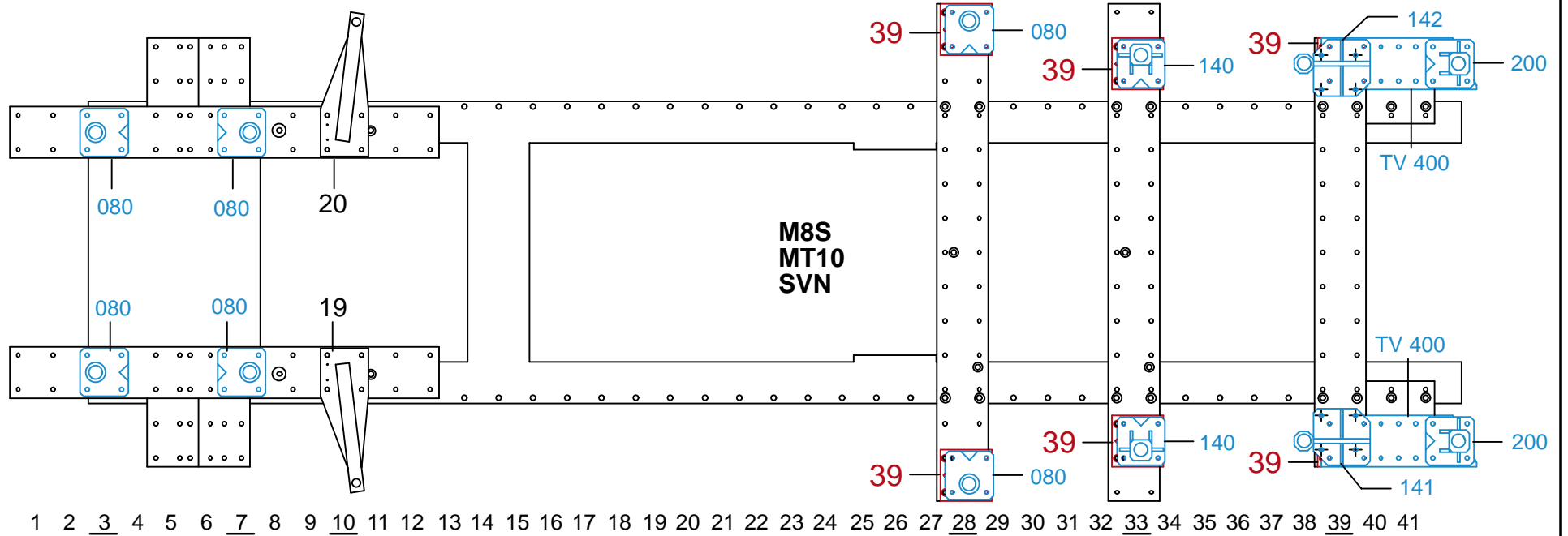

2043.309-RVA3-1 | 00