

REP.	MOD.
24-25	407
26-27	407 SW

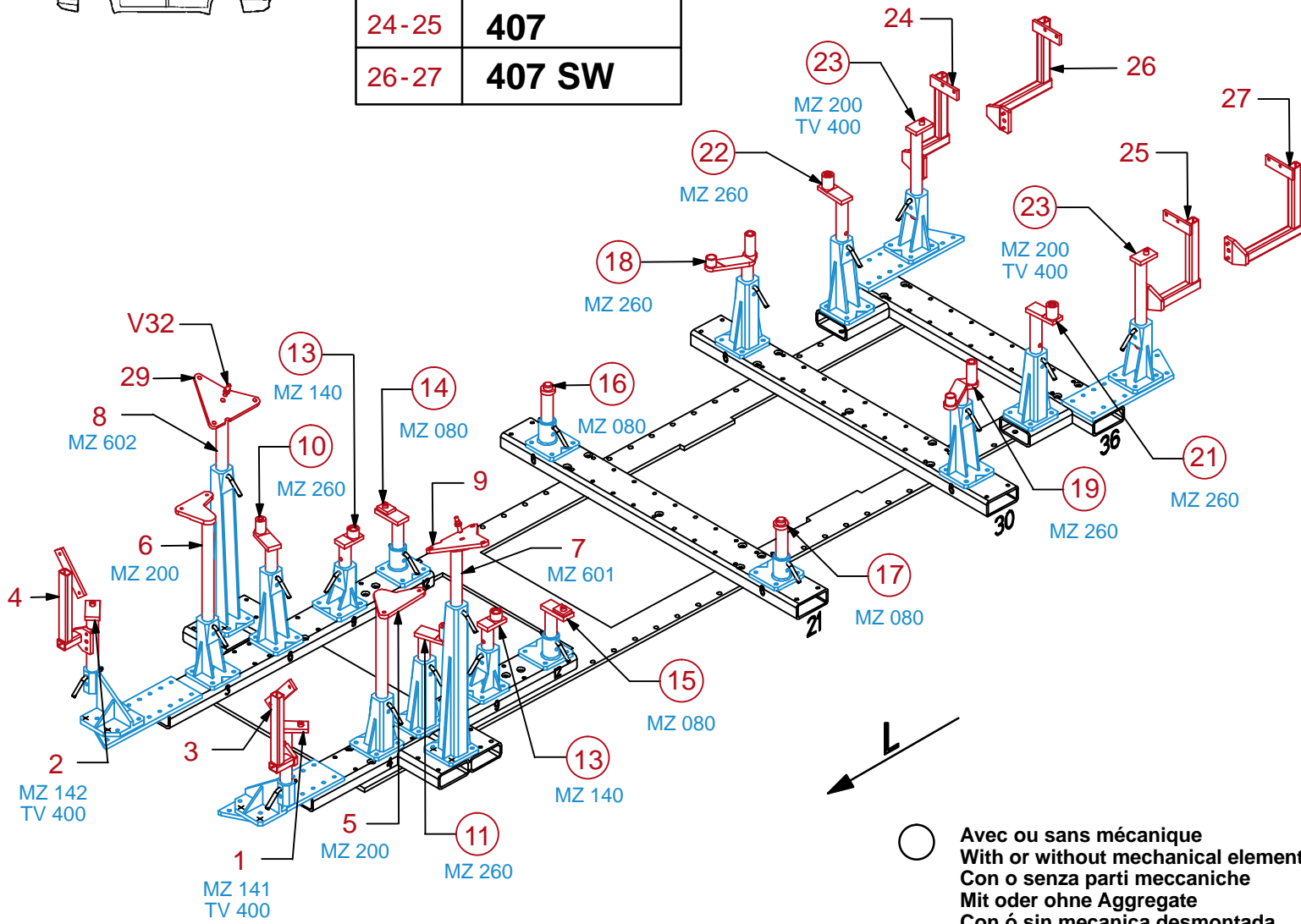

○ Avec ou sans mécanique
 With or without mechanical elements
 Con o senza parti meccaniche
 Mit oder ohne Aggregate
 Con ó sin mecanica desmontada

PEUGEOT

REP.	REFERENCE	PDS	NB	MZ
1	2042.7001	3,2	1	141
2	2042.7002	3,2	1	142
3	2042.7003	2,3	1	
4	2042.7004	2,3	1	
5	2042.7005	3,8	1	200
6	2042.7006	3,4	1	200
7	2042.7007	2,2	1	601
8	2042.7008	2,2	1	602
9	2042.7009	2,4	1	
10	2042.7010	2,6	1	260/080
11	2042.7011	2,6	1	260/080
12	2042.7012	0,9	2	
13	2042.7013	2,2	2	140
14	2042.7014	2,6	1	080
15	2042.7015	2,6	1	080
16	2042.7016	2,0	1	080
17	2042.7017	2,0	1	080
18	2042.7018	3,0	1	260/200
19	2042.7019	3,0	1	260/200
20	2042.7020	0,3	2	
21	2042.7021	3,1	1	260
22	2042.7022	3,1	1	260
23	2042.7023	3,8	2	200
24	2042.7024	2,2	1	
25	2042.7025	2,2	1	
26	2042.7026	2,6	1	
27	2042.7027	2,6	1	
28	2042.7028	1,0	1	
29	2042.7029	2,4	1	
	V32	0,1	2	

M 8-25	8
M 8-30	2
M 10-35	2
M 12-25	4
M 12-30	6
M 12-90	2
M 12-100	2
M 12-110	2
M 12-150	2
M 12-170	2
M 14-60	2
M 14-90	2
M 14-110	2
M 12	6
MU 12	2

2042.300

81 Kg 05.04.2004 423-D-22A

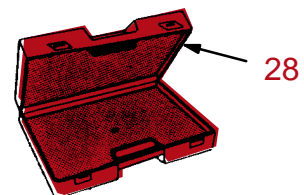
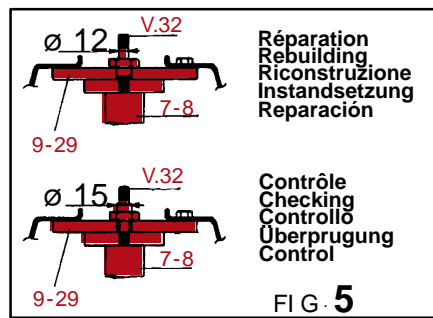
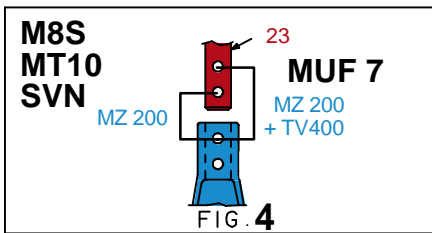
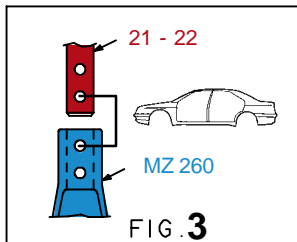
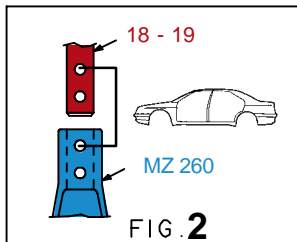
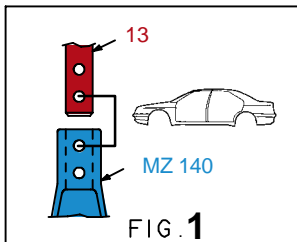
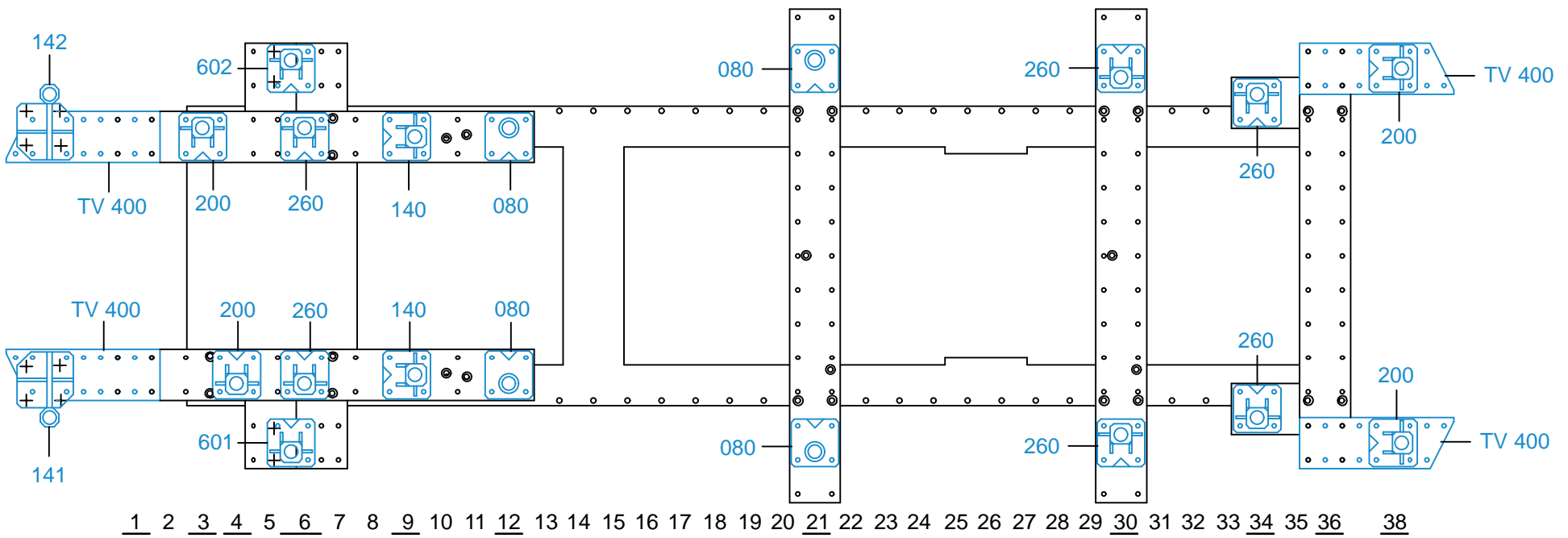

2042.300-RVA3-1 00

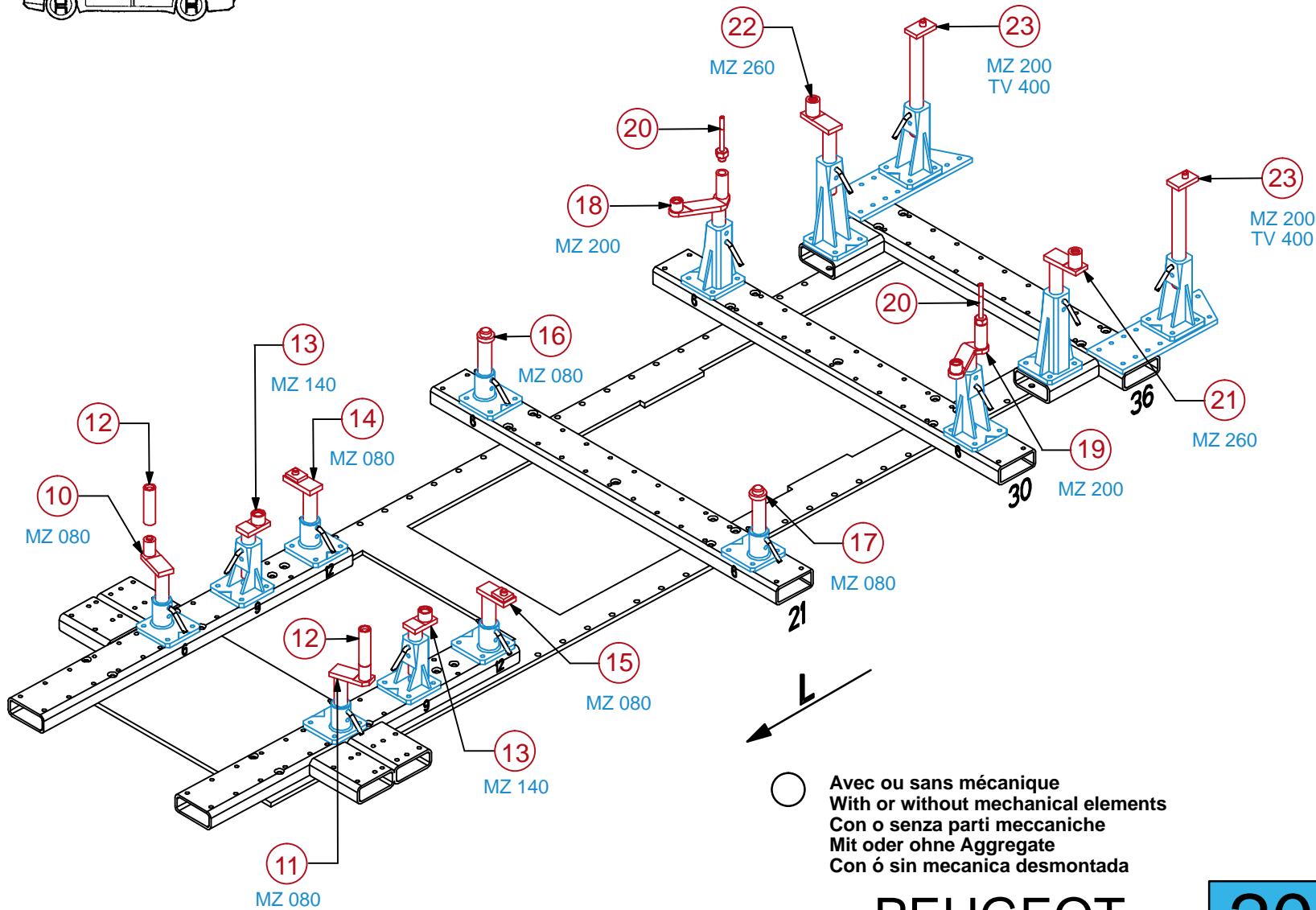

○ Avec ou sans mécanique
 With or without mechanical elements
 Con o senza parti meccaniche
 Mit oder ohne Aggregate
 Con ó sin mecánica desmontada

PEUGEOT

2042.300		
81 Kg	05.04.2004	423-D-22B

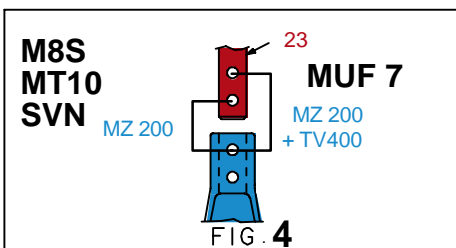
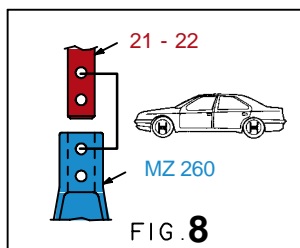
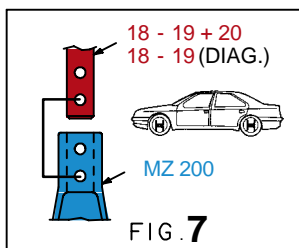
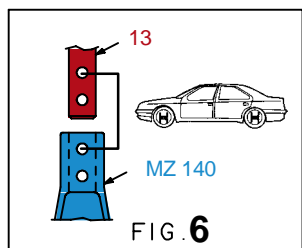
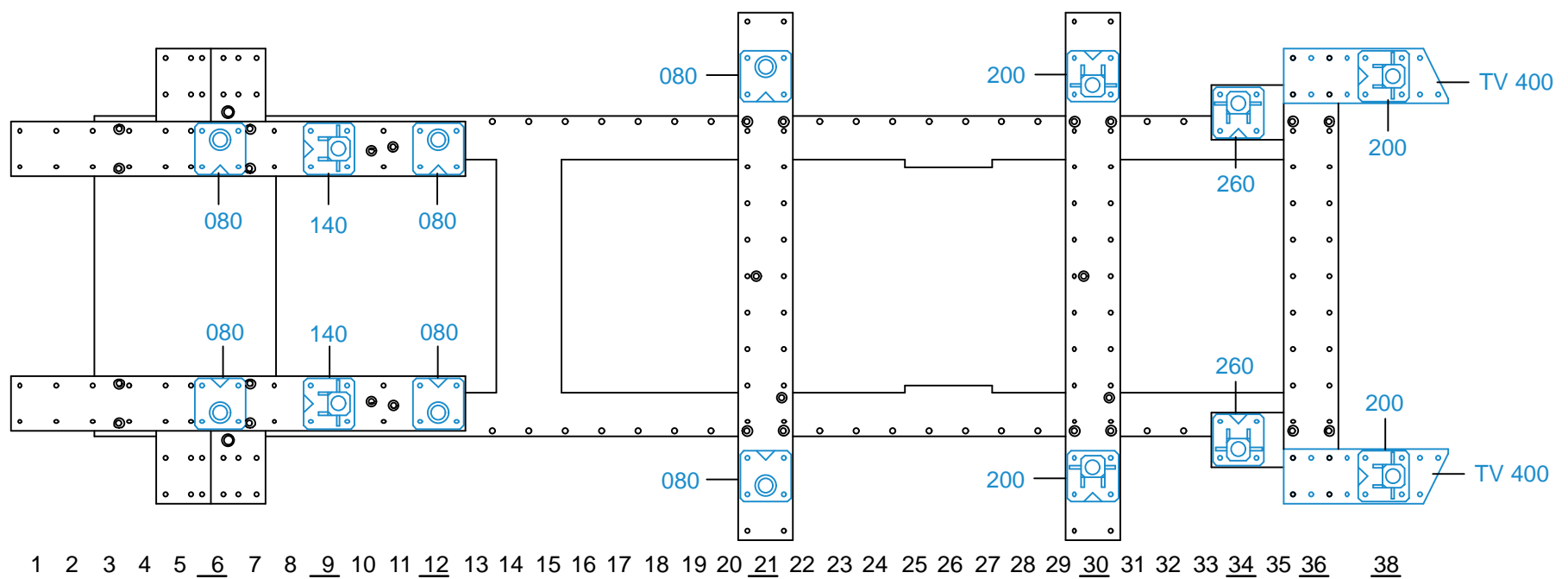

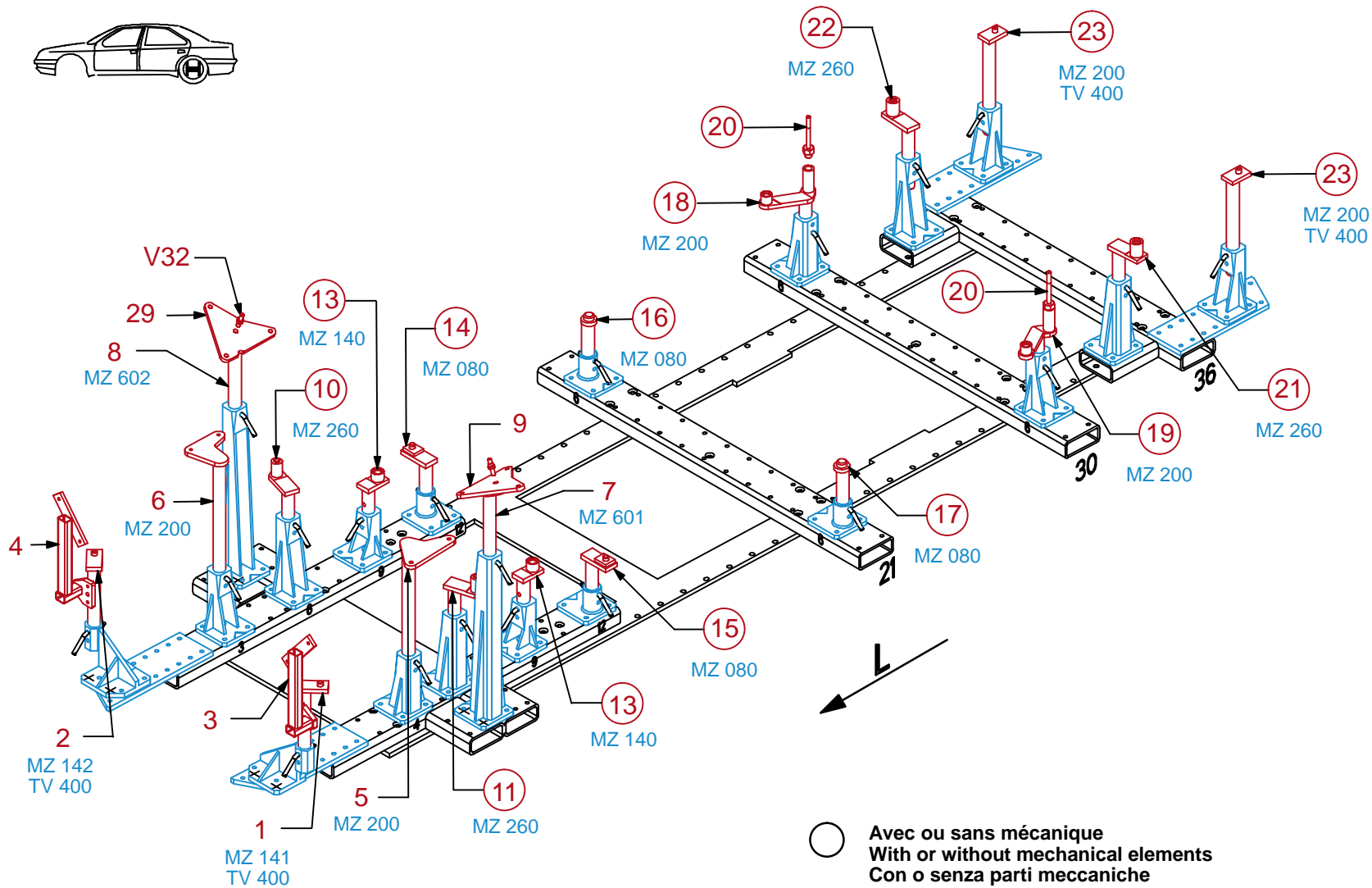
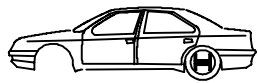

○ Avec ou sans mécanique
 With or without mechanical elements
 Con o senza parti meccaniche
 Mit oder ohne Aggregate
 Con ó sin mecanica desmontada

PEUGEOT

2042.300

81 Kg | 05.04.2004 | 423-D-22C

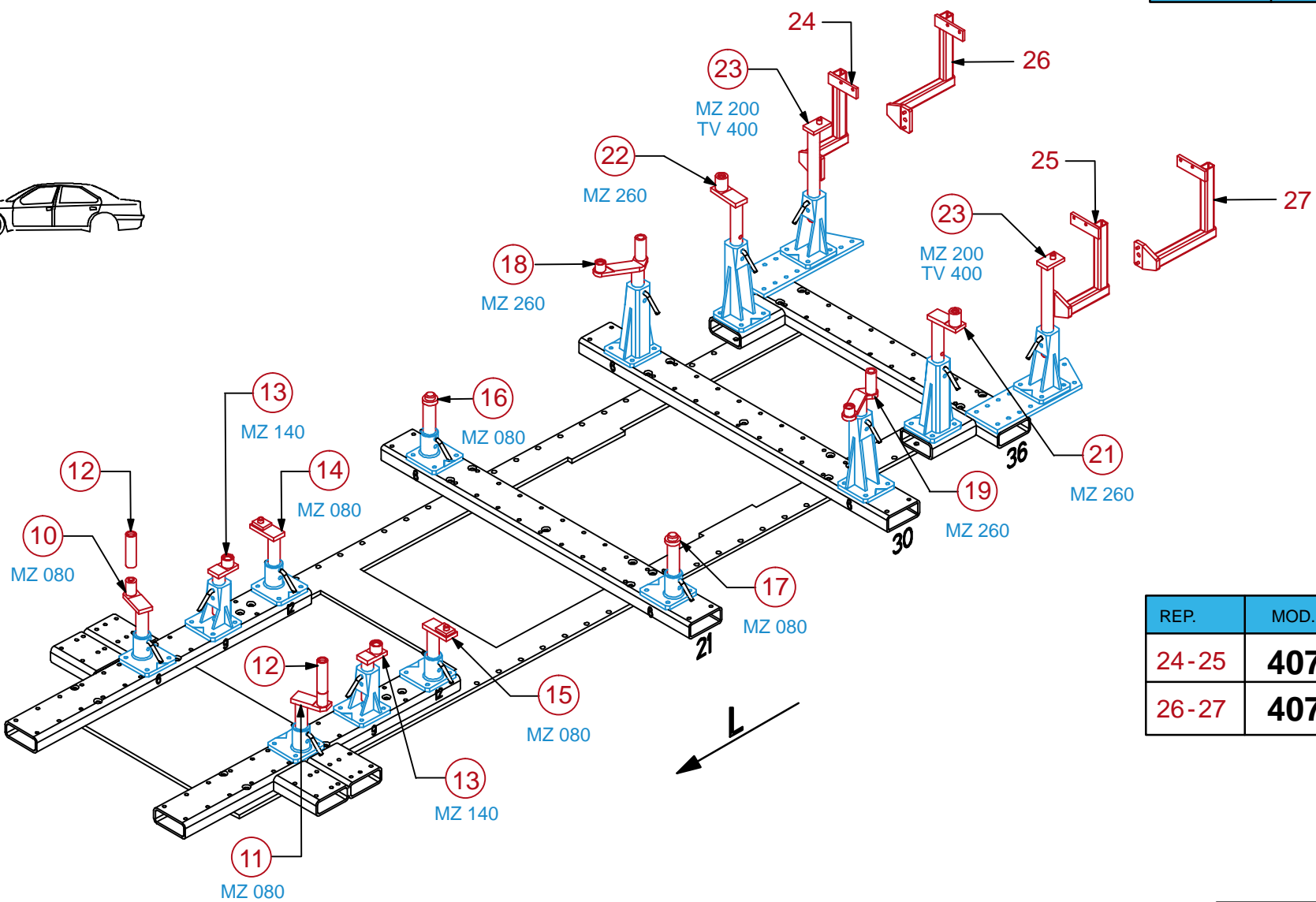

REP.	MOD.
24-25	407
26-27	407 SW

2042.300-RA3-2 | 00