

- Berceau arrière rigide
- Rigid Rear Subframe Model
- Starre Hinterachse
- Telaio posteriore rigido
- Bastidor trasero rigido

REP.	REFERENCE	PDS	NB	MZ
1	2037.7001	1,1	1	141
2	2037.7002	1,1	1	142
3	2037.7003	2,7	1	140/080
4	2037.7004	2,7	1	140/080
5	2037.7005	3,1	1	601
6	2037.7006	3,1	1	602
7	2037.7007	2,3	1	260
8	2037.7008	2,3	1	260
9	2037.7009	1,7	1	140/080
10	2037.7010	1,7	1	140/080
11	2037.7011	1,2	1	080
12	2037.7012	1,1	1	080
13	2037.7013	1,5	1	140
14	2037.7014	1,5	1	140
15	2037.7015	1,7	1	200/140
16	2037.7016	1,7	1	200/140
17	2037.7017	2,9	1	601
18	2037.7018	2,9	1	602
19	2037.7019	0,3	2	
20	2037.7020	2,5	1	260/080
21	2037.7021	2,5	1	260/080
22	2037.7022	2,2	1	200
23	2037.7023	2,2	1	200
24	2037.7024	3,7	2	
25	2037.7025	1,9	2	
26	2037.7026	0,4	2	
V73		0,01	2	

- M 12-25
- M 10x1,25-80
- M 12x1,25-40
- M 14x1,50-40
- M 14x1,50-90
- M 14x1,50-100
- M 14x1,50-110
- M 14x1,50-120
- M 14x1,50-130
- M 14x1,50-180
- M 14x1,50-190
- TFHc 16-60
- 955714

○ Avec ou sans mécanique
 With or without mechanical elements
 Con o senza parti meccaniche
 Mit oder ohne Aggregate
 Con ó sin mecanica desmontada

HONDA / ACURA

2037.300

62 Kg 02.03.2004 413-D-40A

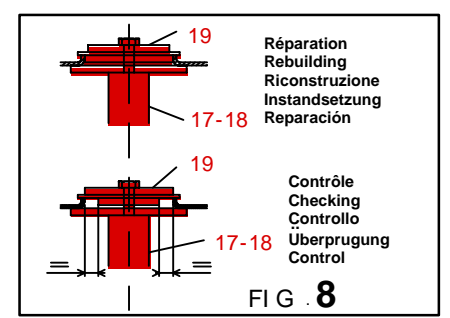
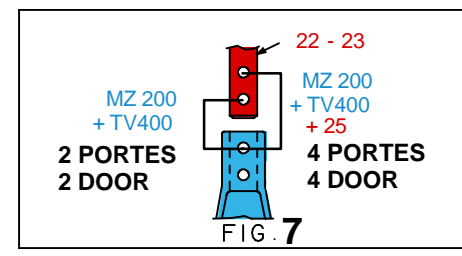
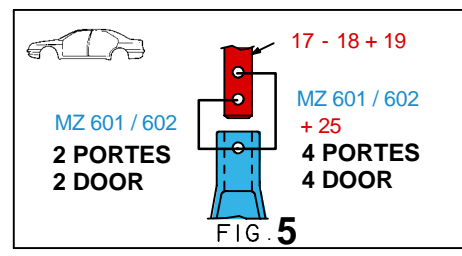
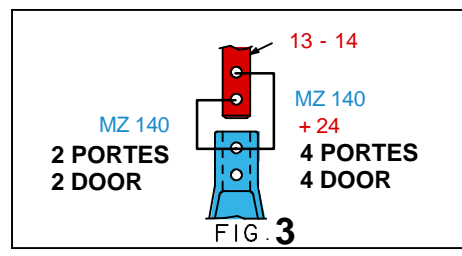
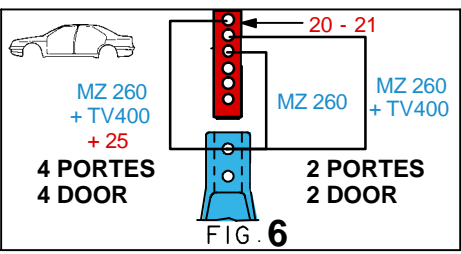
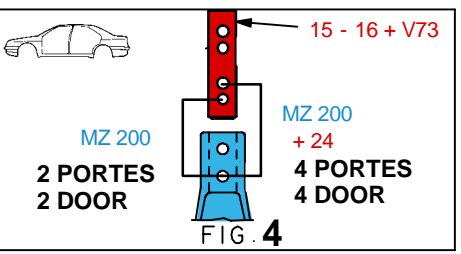
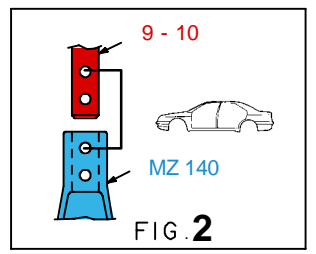
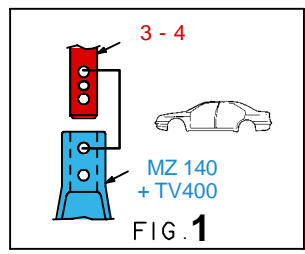
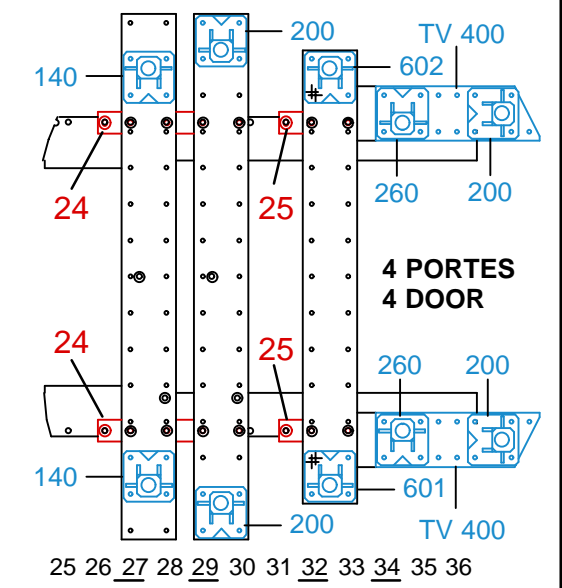
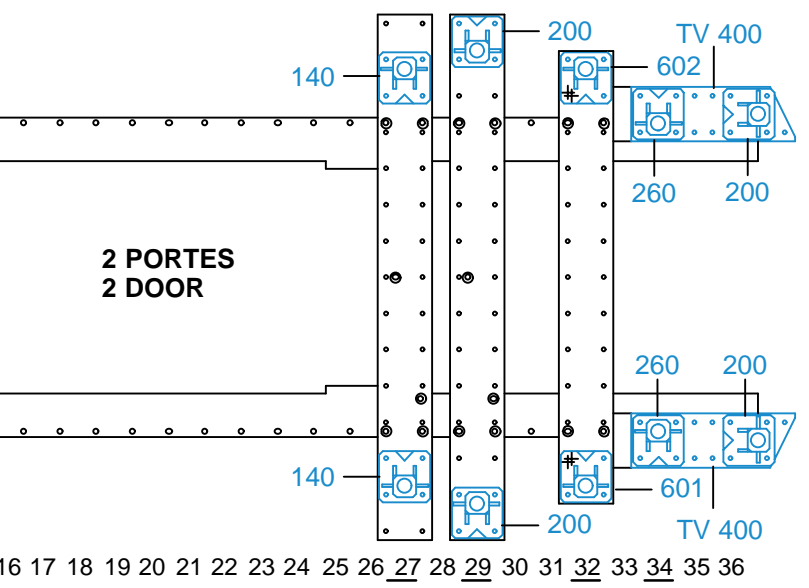
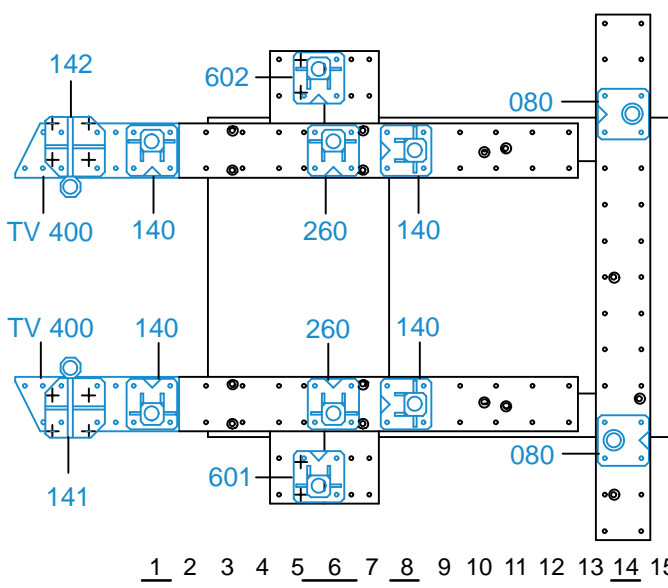

2037.300-RVA3-1 00

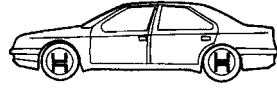
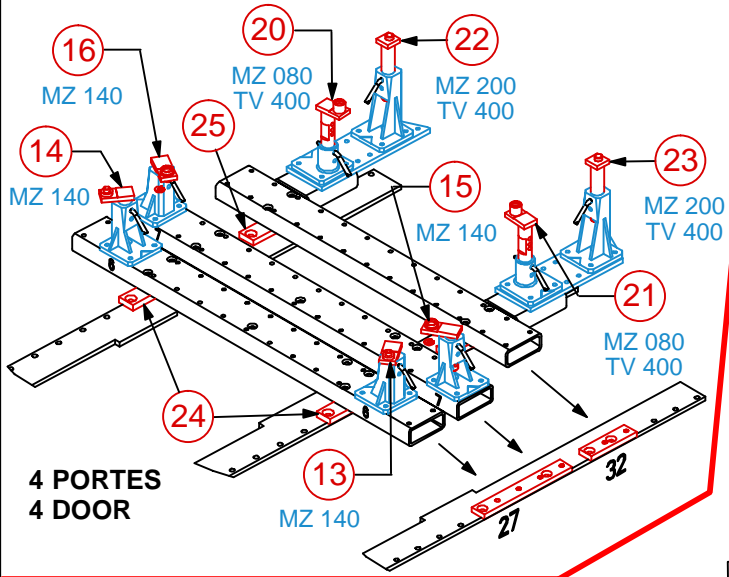

- Berceau arrière rigide
- Rigid Rear Subframe Model
- Starre Hinterachse
- Telaio posteriore rigido
- Bastidor trasero rigido

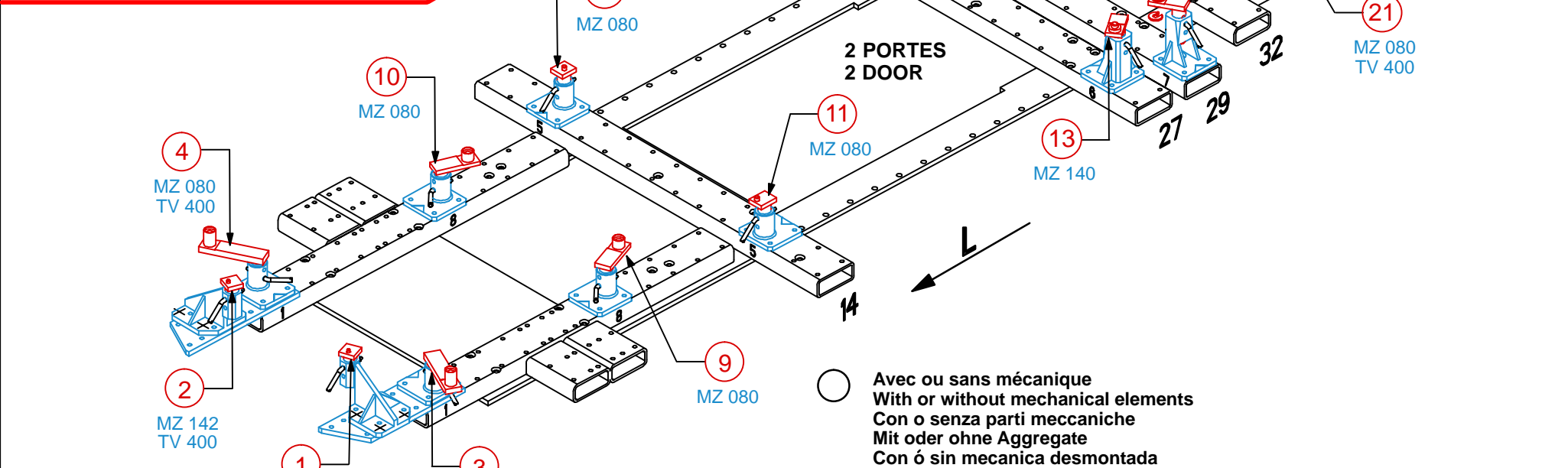

HONDA / ACURA

2037.300

62 Kg	02.03.2004	413-D-40B
-------	------------	-----------

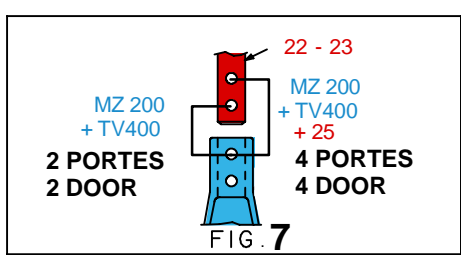
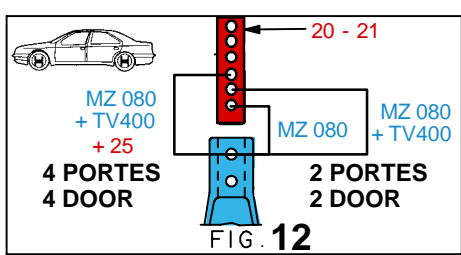
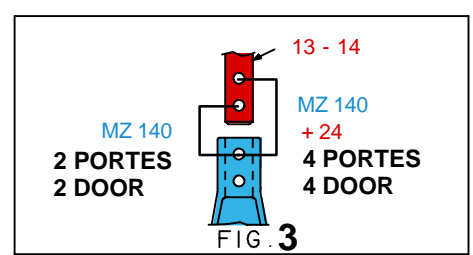
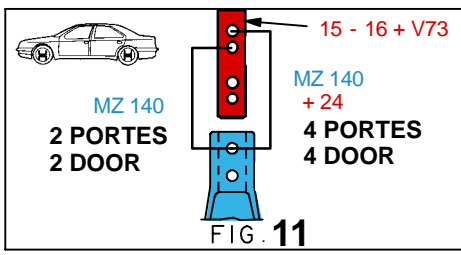
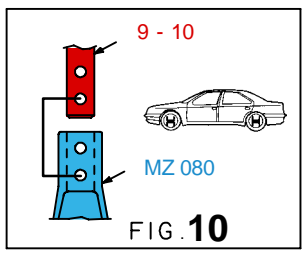
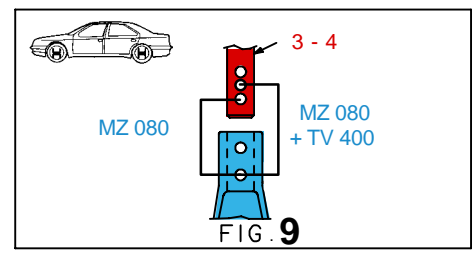
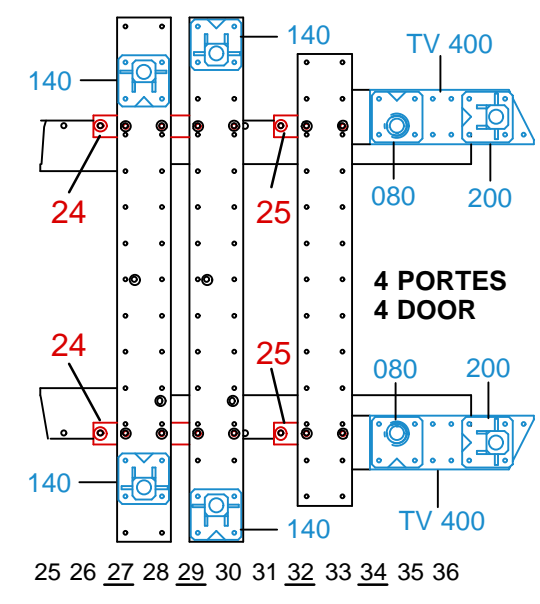
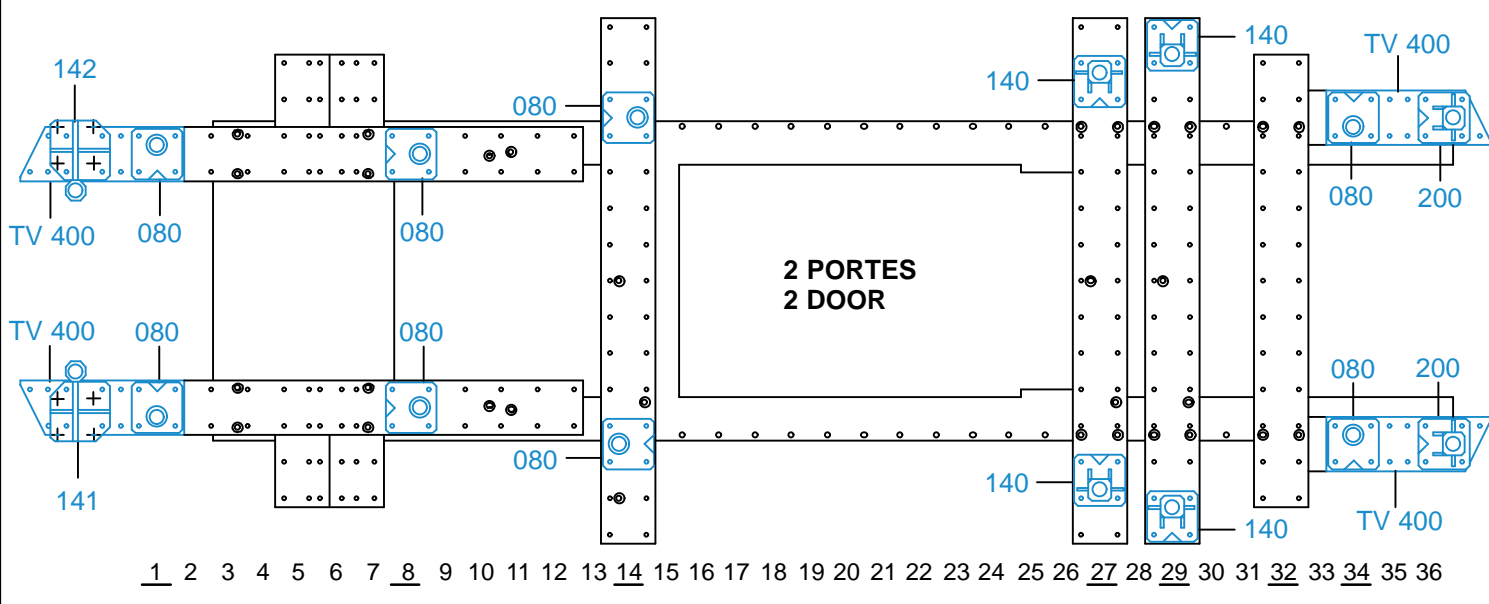

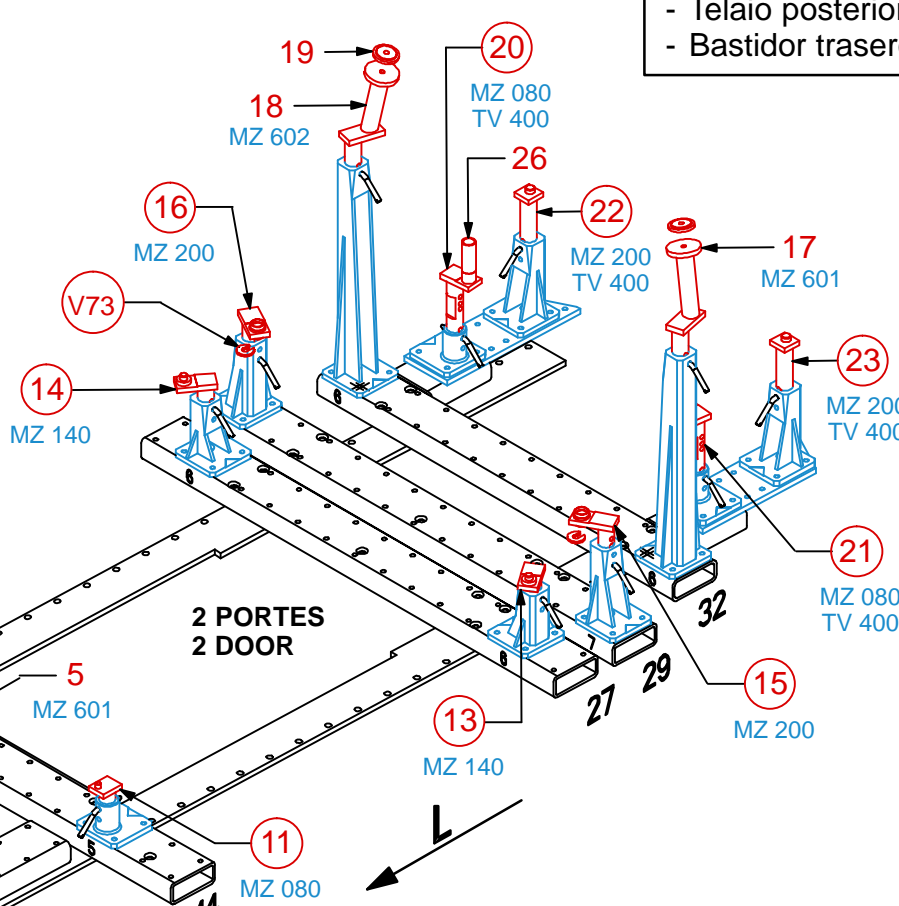
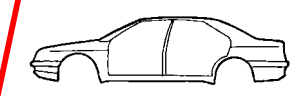
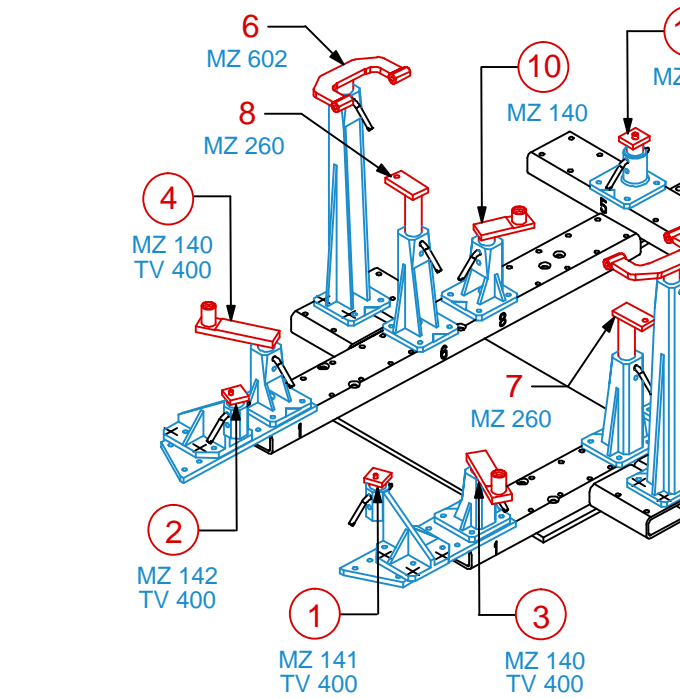
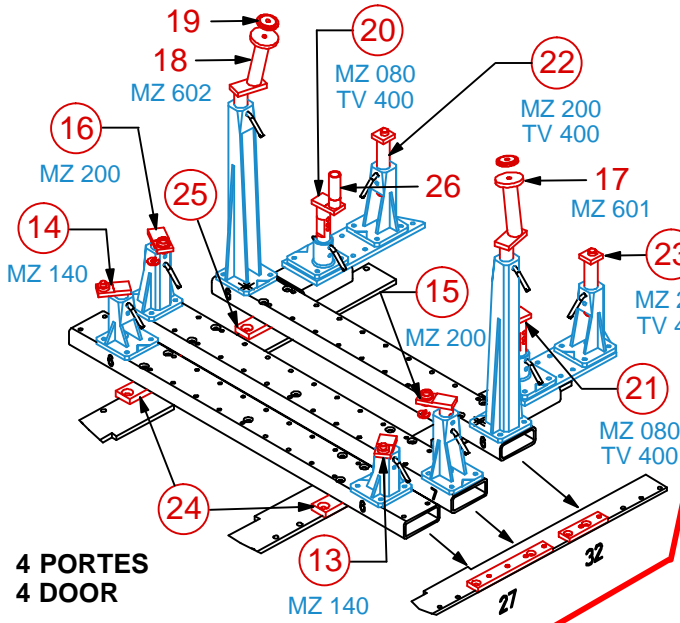

- Berceau arrière non rigide
- Floating Rear Subframe Model
- Biegsame Hinterachse
- Telaio posteriore flessibile
- Bastidor trasero no rigido

○ Avec ou sans mécanique
 With or without mechanical elements
 Con o senza parti meccaniche
 Mit oder ohne Aggregate
 Con ó sin mecanica desmontada

HONDA / ACURA

2037.300

62 Kg	02.03.2004	413-D-40C
-------	------------	-----------

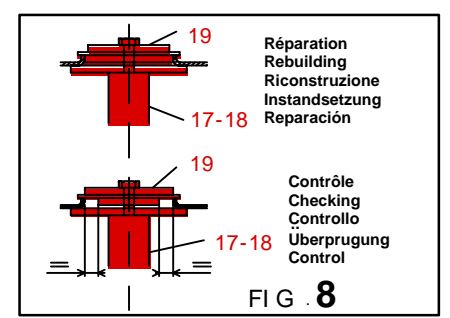
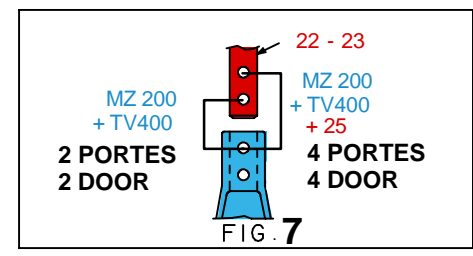
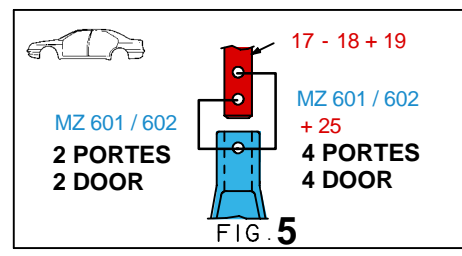
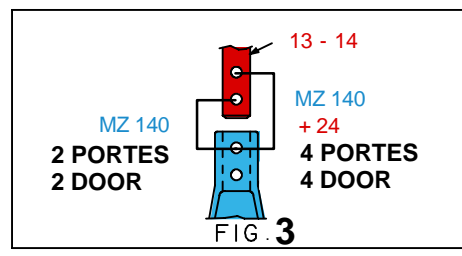
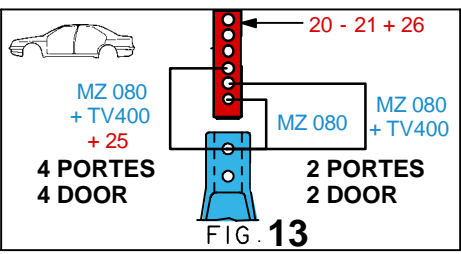
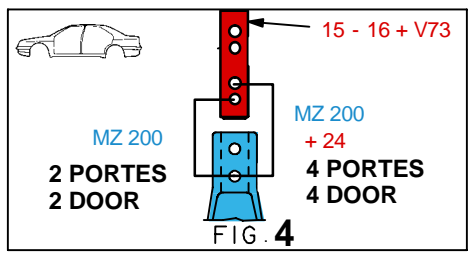
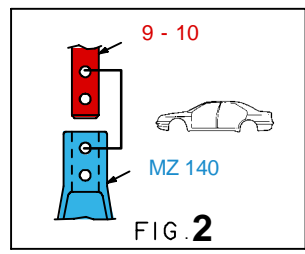
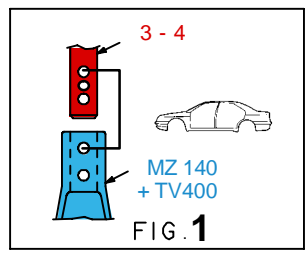
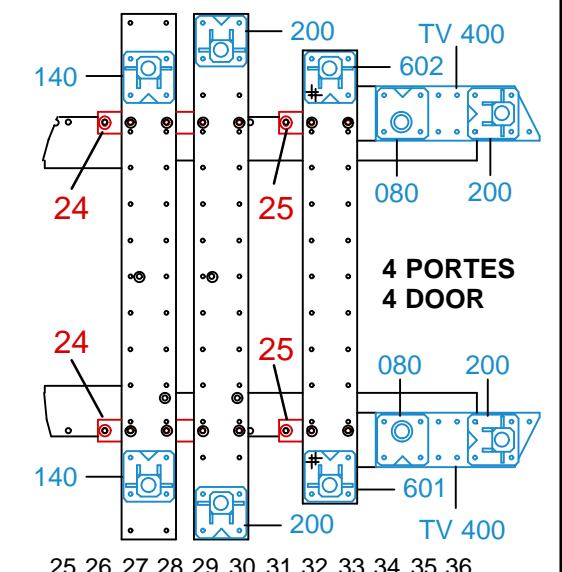
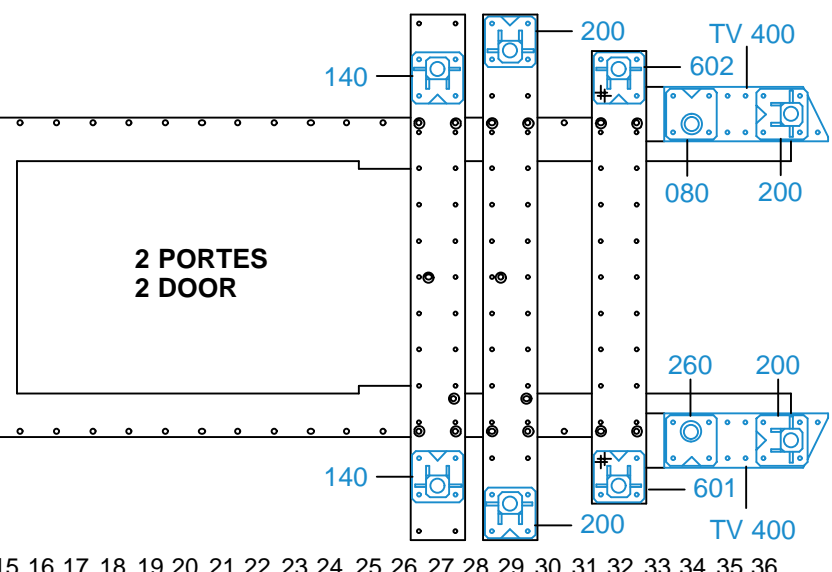
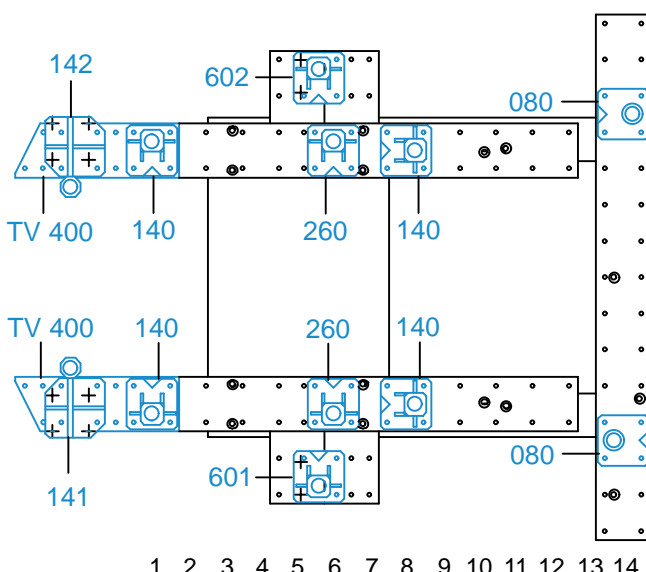

2037.300-RVA3-2 00

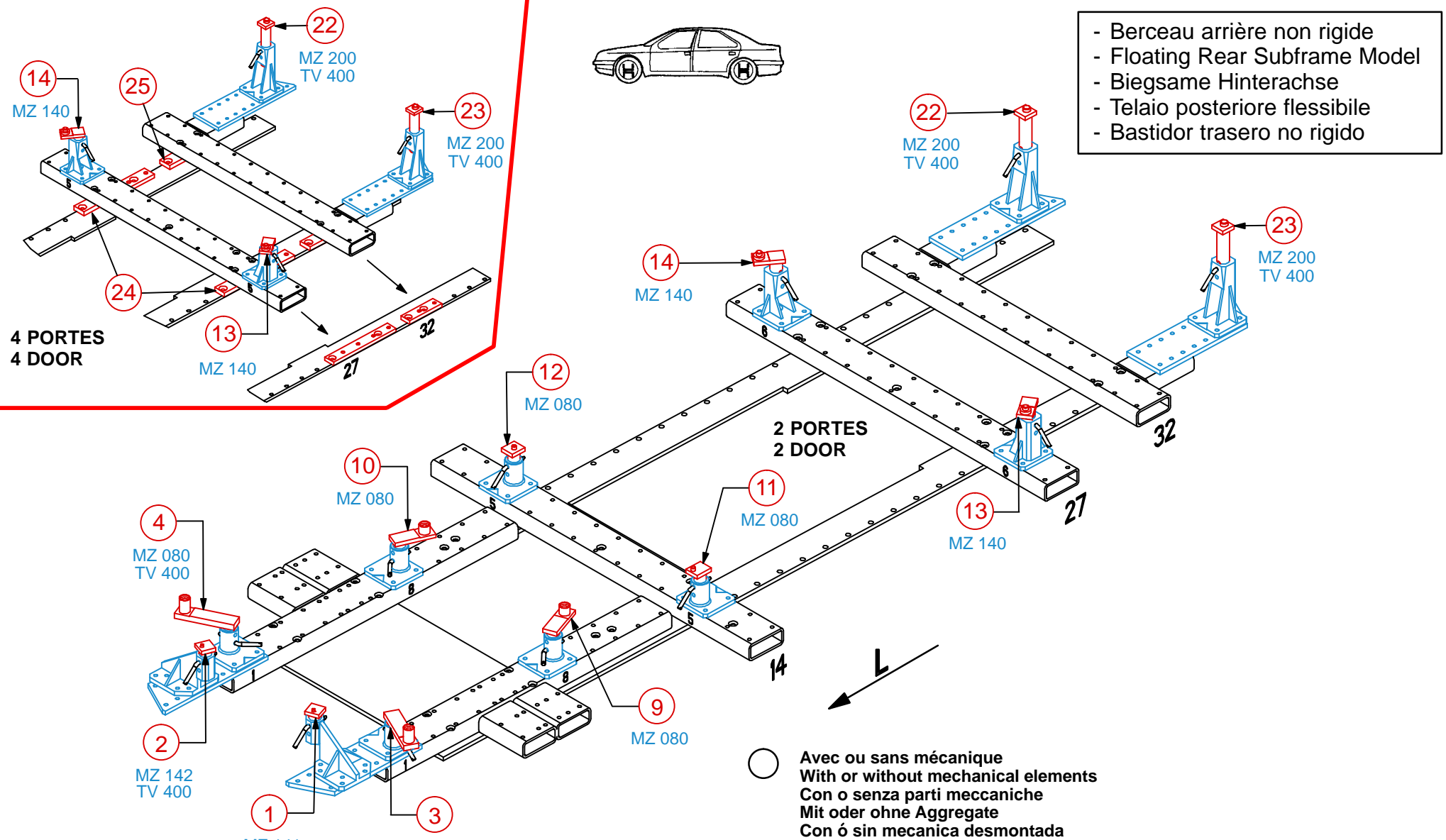

- Berceau arrière non rigide
- Floating Rear Subframe Model
- Biegsame Hinterachse
- Telaio posteriore flessibile
- Bastidor trasero no rígido

HONDA / ACURA

2037.300

62 Kg	02.03.2004	413-D-40D
-------	------------	-----------

