

○ Avec ou sans mécanique
 With or without mechanical elements
 Con o senza parti meccaniche
 Mit oder ohne Aggregate
 Con ó sin mecanica desmontada

MAZDA

REP.	REFERENCE	PDS	NB	MZ
1	2036.7001	2,7	1	260
2	2036.7002	2,7	1	260
3	2036.7003	3,1	1	142
4	2036.7004	3,1	1	141
5	2036.7005	1,8	1	260/080
6	2036.7006	1,8	1	260/080
7	2036.7007	1,3	2	
8	2036.7008	1,9	1	602
9	2036.7009	1,9	1	601
10	2036.7010	0,2	2	
11	2036.7011	1,6	1	140/080
12	2036.7012	1,6	1	140/080
13	2036.7013	1,4	1	080
14	2036.7014	1,4	1	080
15	2036.7015	1,4	1	140/080
16	2036.7016	1,4	1	140/080
17	2036.7017	0,3	2	
18	2036.7018	0,4	2	
19	2036.7019	2,8	1	260
20	2036.7020	2,8	1	260
21	2036.7021	1,7	1	200
22	2036.7022	1,7	1	200
23	2036.7023	0,7	2	
24	2036.7024	0,4	2	
25	2036.7025	1,6	1	200
26	2036.7026	1,6	1	200
27	2036.7027	0,3	4	

	M 8-35	4
	M 12-20	2
	M 12-40	2
	M 12x1,25-20	2
	M 12x1,25-25	2
	M 14x1,50-80	2
	M 12x1,25	4
	M 14x1,50	4
	LU 12	6

2036.300

49 Kg	30.10.2007	419-D-30A
-------	------------	-----------

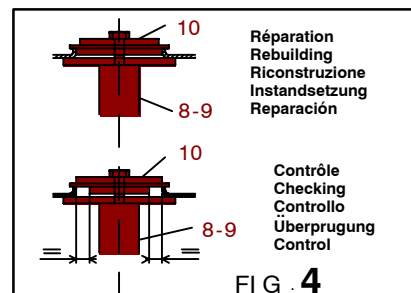
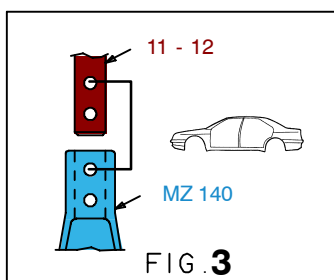
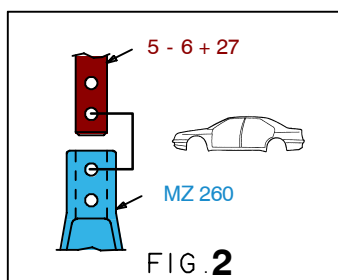
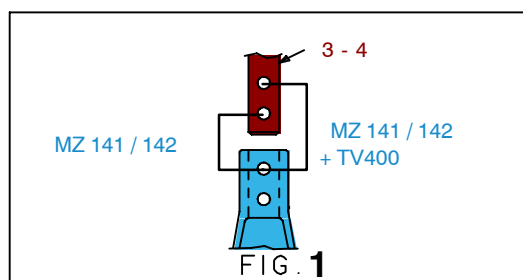
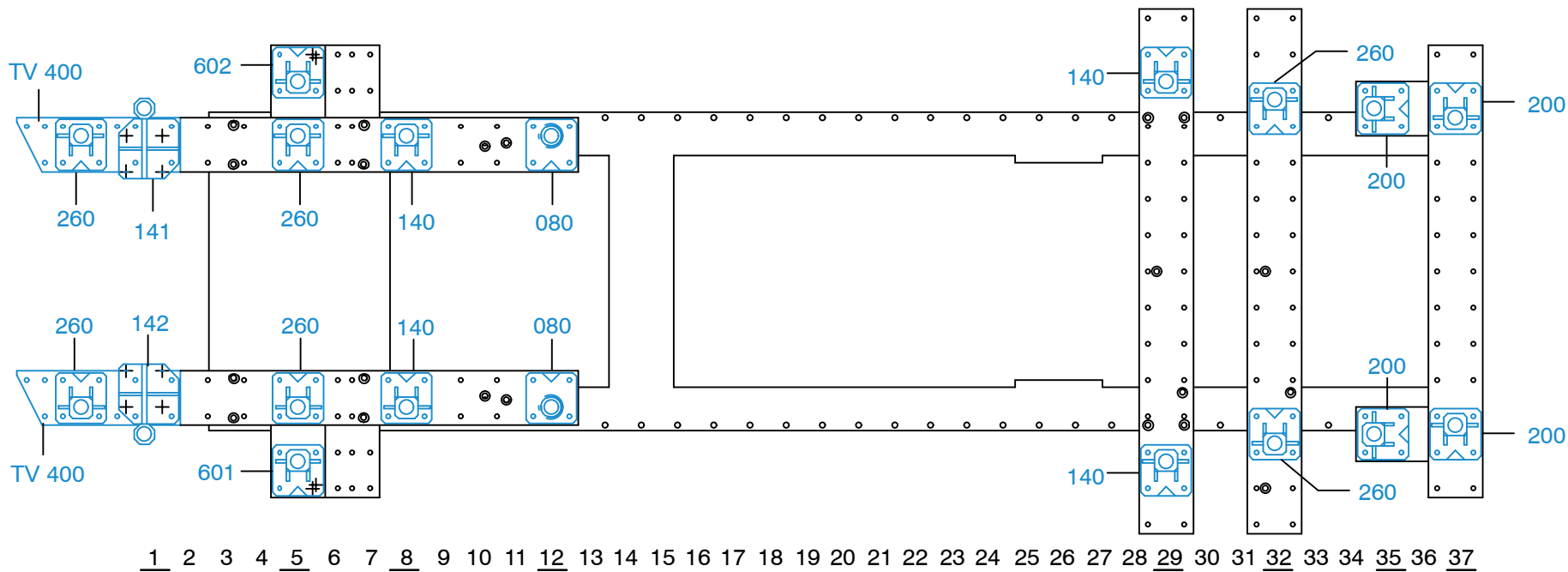

2036.300-RVA3-1 00

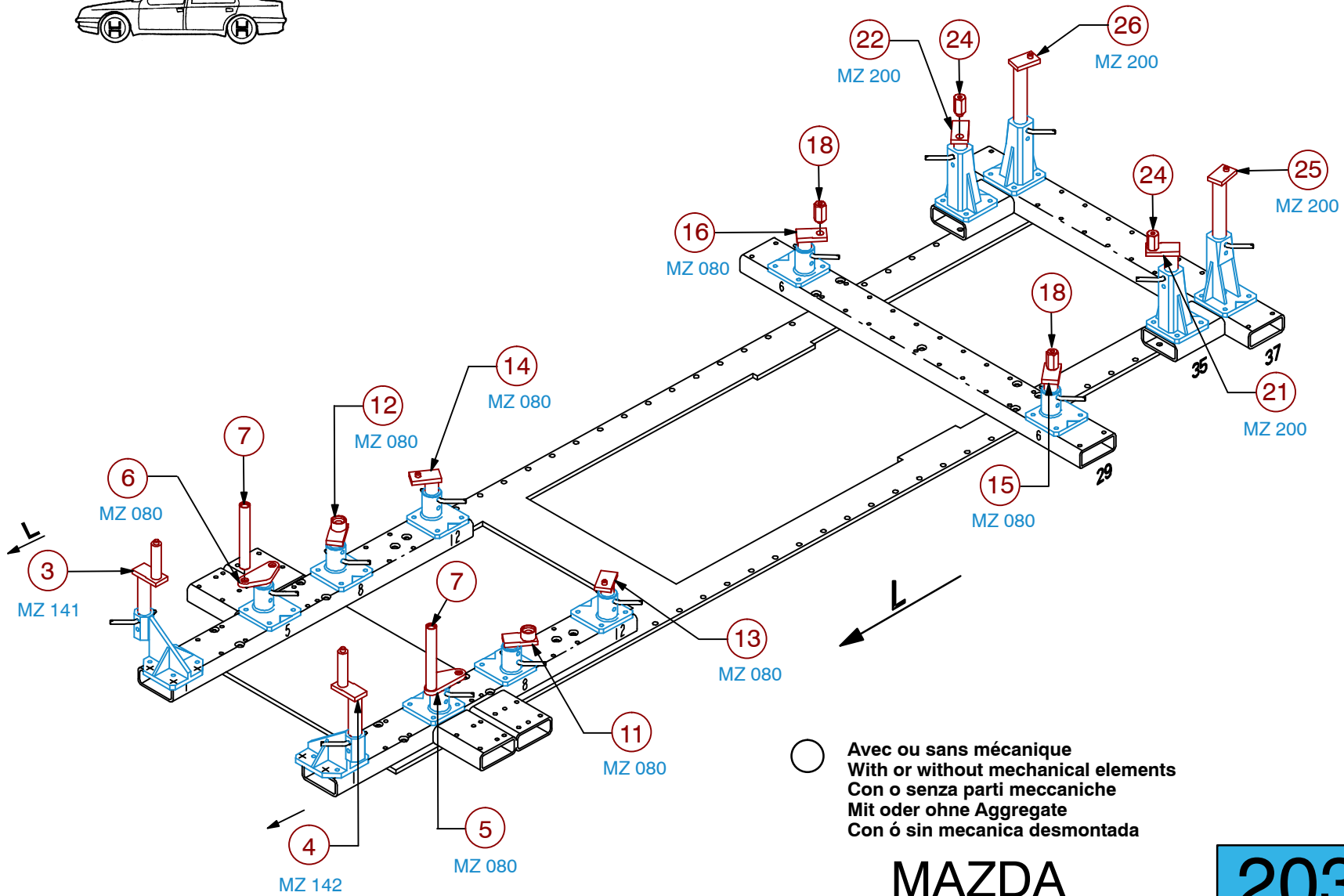
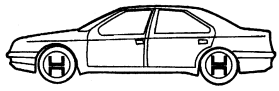

MAZDA

2036.300		
49 Kg	30.10.2007	419-D-30B

