

VAS 6240/4



Avec ou sans mécanique
With or without mechanical elements
Con o senza parti meccaniche
Mit oder ohne Aggregate
Con ó sin mecanica desmontada

REP.	REFERENCE	PDS	NB	MZ
48	2010.7048	3,1	1	
49	2010.7049	3,1	1	
50	2010.7050	3,4	1	141
51	2010.7051	2,8	1	142

	M 8-25	4
	M 10-40	2

complément au
complementary set to
complemento al
zusatz zu

2035.300
Ou/Or/Oder/O

2010.300 + 2010.309

2035.308

13 Kg 03.03.2004 433-D-7A

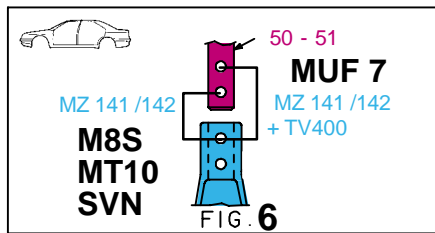
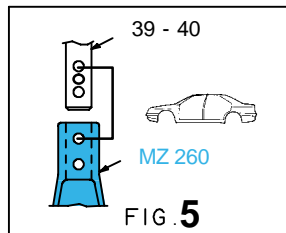
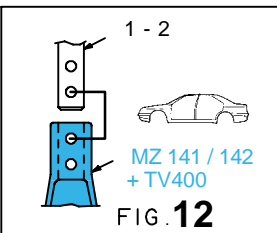
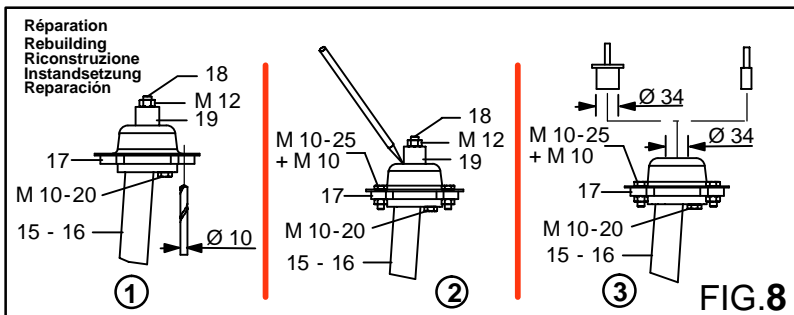
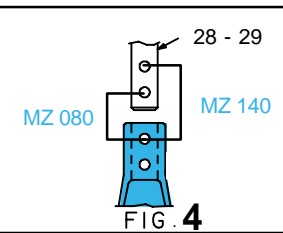
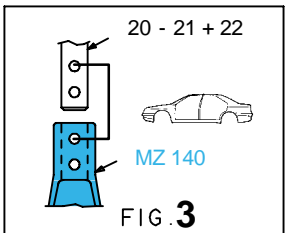
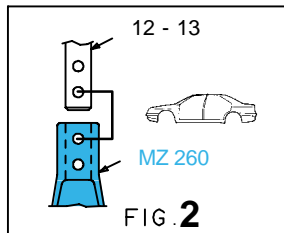
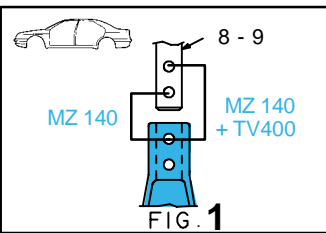
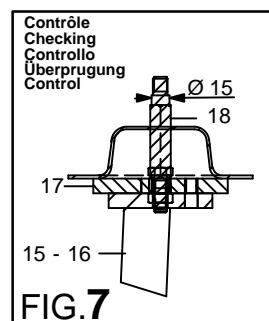
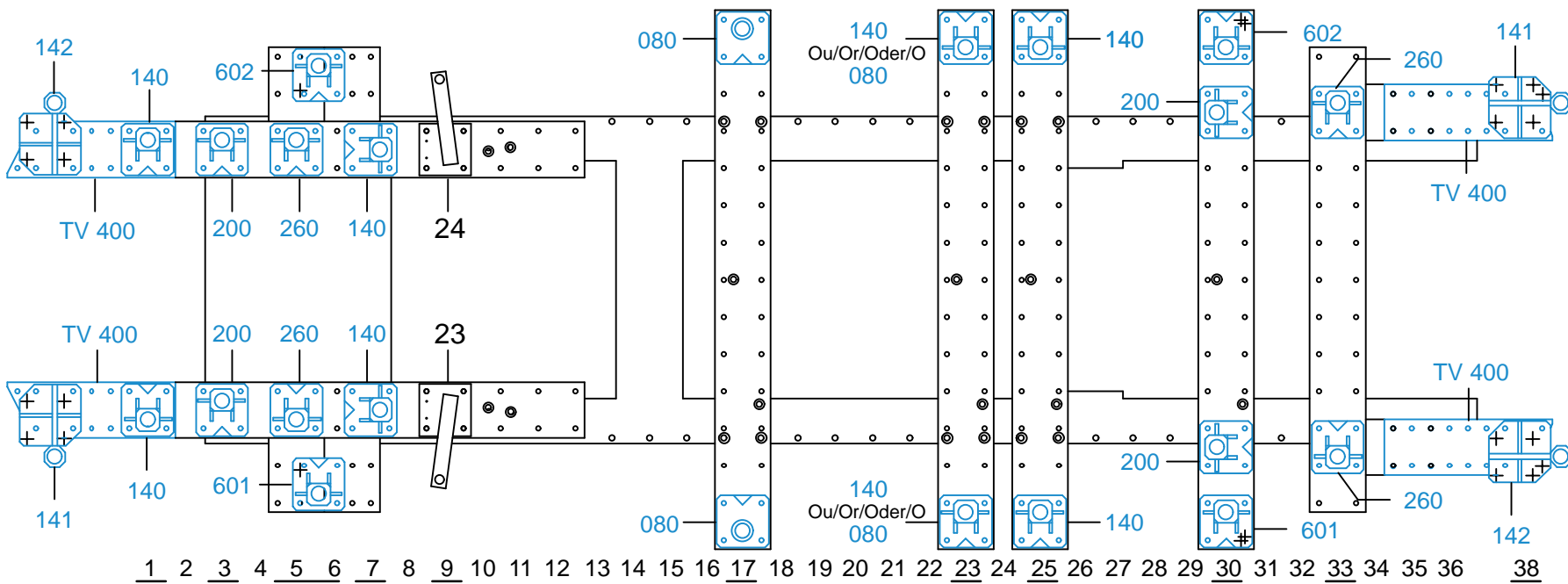

2035.308-RVA3-1 00

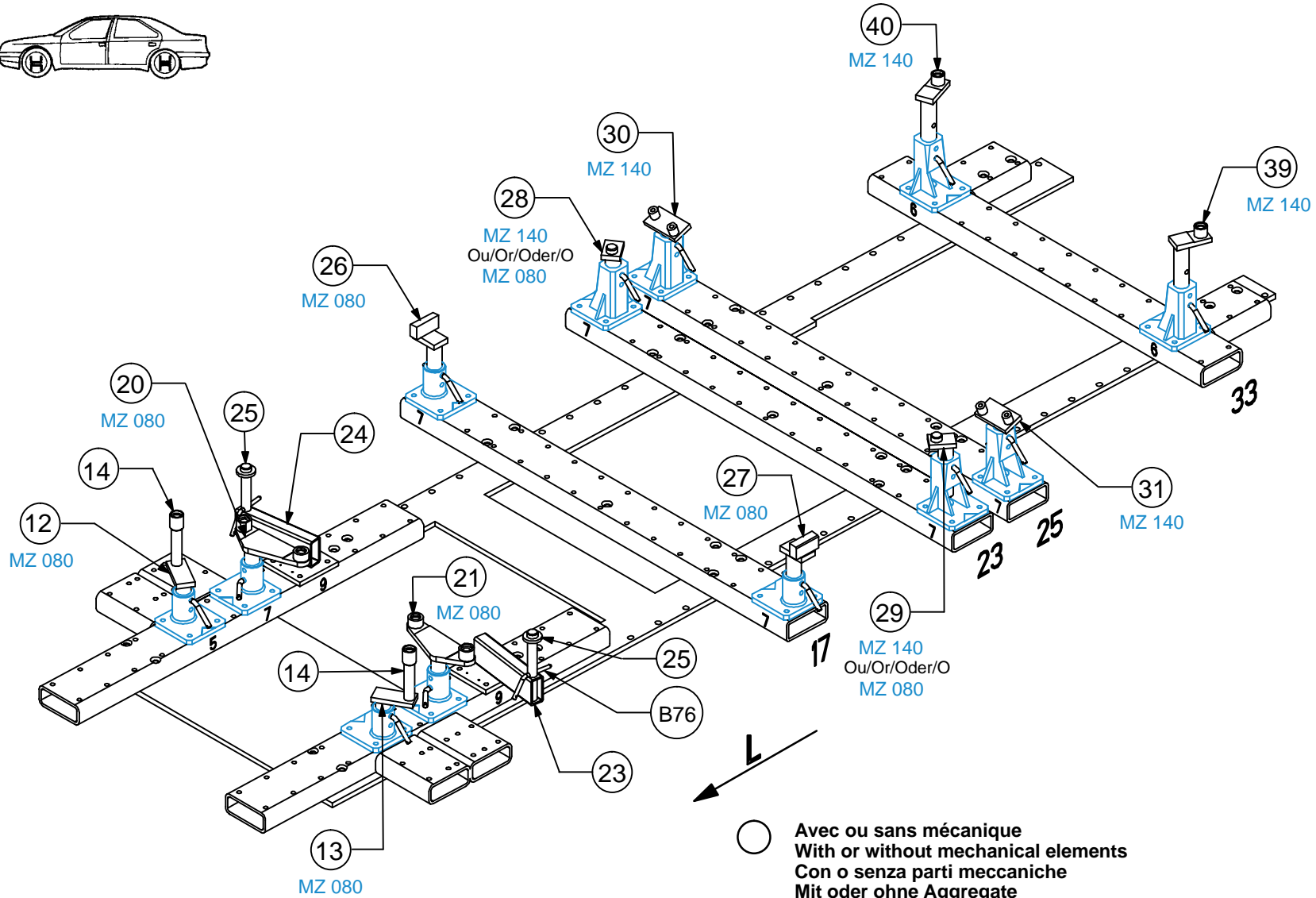
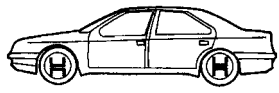

○ Avec ou sans mécanique
 With or without mechanical elements
 Con o senza parti meccaniche
 Mit oder ohne Aggregate
 Con ó sin mecanica desmontada

VAS 6240/4



2035.308

13 Kg	03.03.2004	433-D-7B
-------	------------	----------

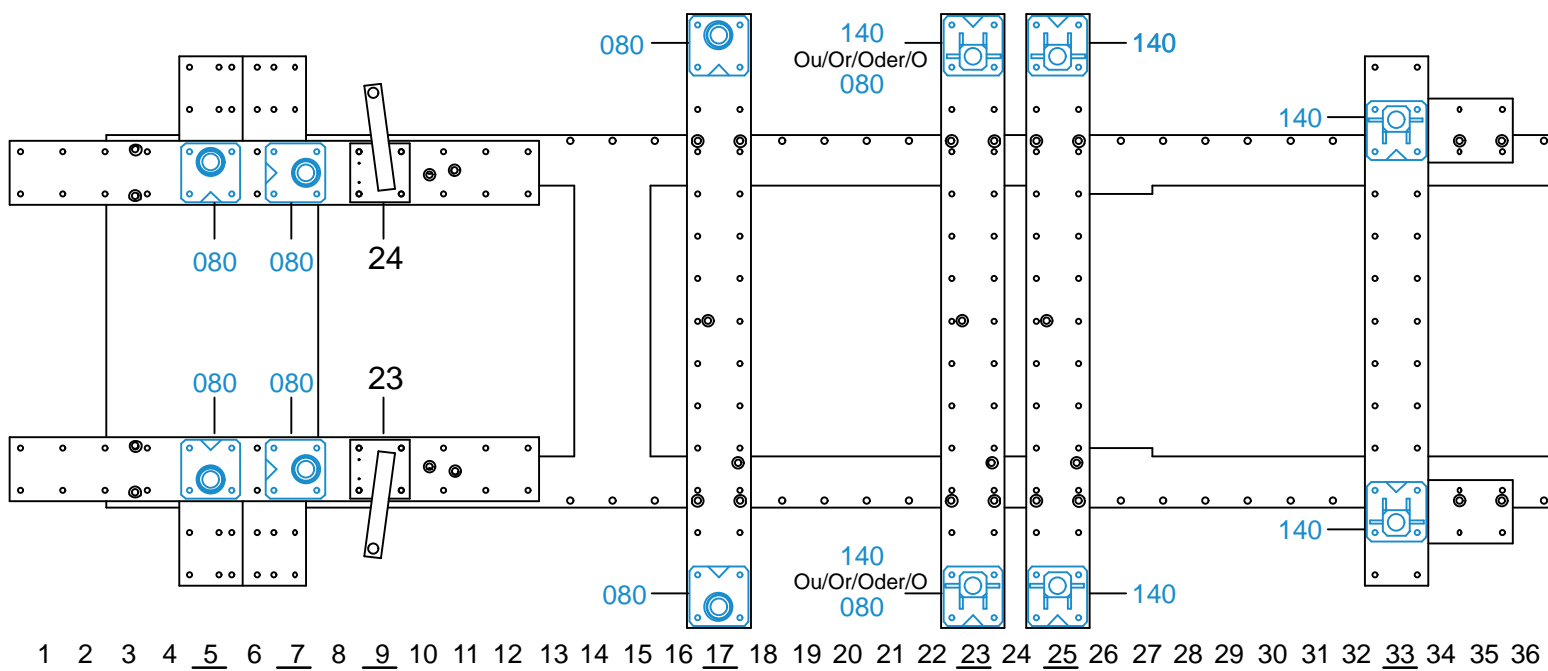

1 2 3 4 5 6 7 8 9 10 11 12 13 14 15 16 17 18 19 20 21 22 23 24 25 26 27 28 29 30 31 32 33 34 35 36

