

○ Avec ou sans mécanique
 With or without mechanical elements
 Con o senza parti meccaniche
 Mit oder ohne Aggregate
 Con ó sin mecanica desmontada

REP.	REFERENCE	PDS	NB	MZ
69 70	2010.7069 2010.7070	2,7 2,7	1 1	
	M 12-40		2	
	M 12		2	
complément au complementary set to complemento al zusatz zu				2035.300 Ou/Or/Oder/O 2010.300 + 2010.309
2035.304				
6 Kg	14.02.2008	431-D-10A		
2035.304 - RVA3-1				02

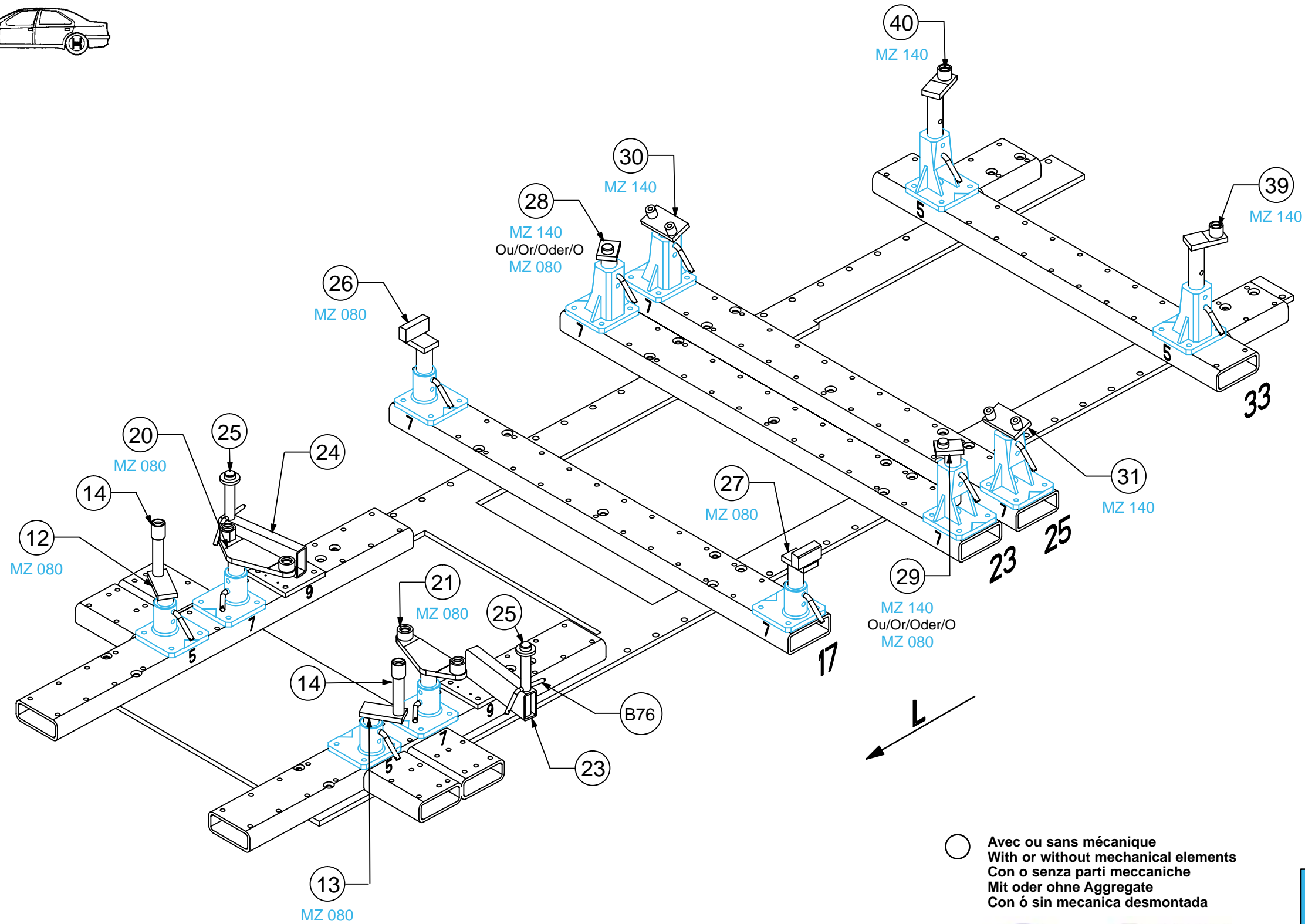
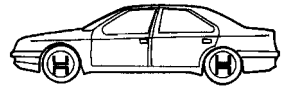

○ Avec ou sans mécanique
 With or without mechanical elements
 Con o senza parti meccaniche
 Mit oder ohne Aggregate
 Con ó sin mecanica desmontada

2035.304

6 Kg	06.04.2005	431-D-10B
2035.304 - RVA3 - 1		00

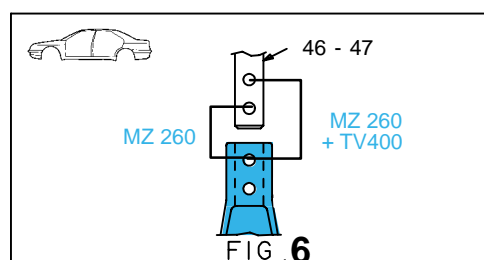
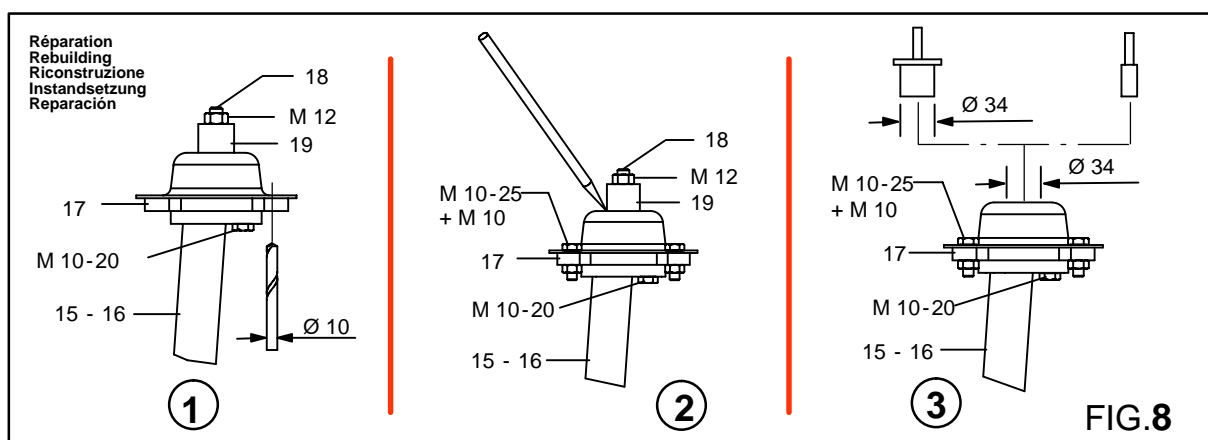
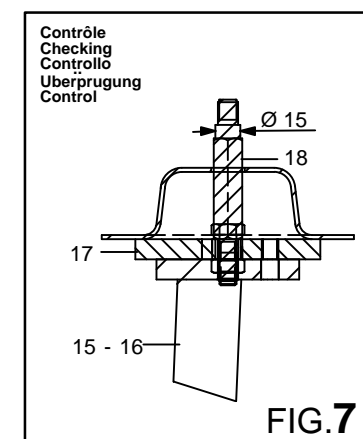
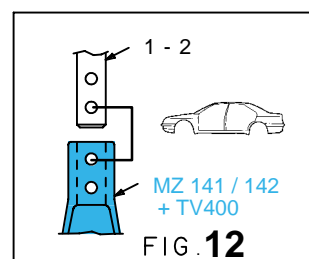
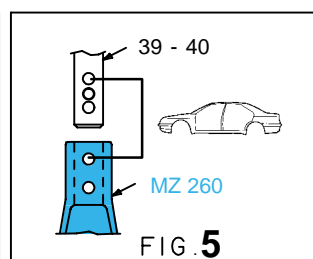
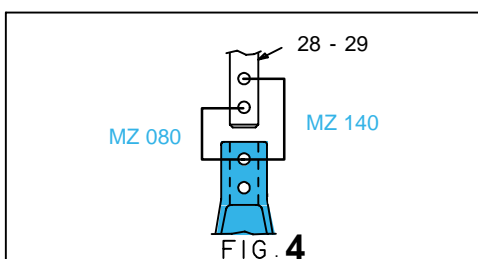
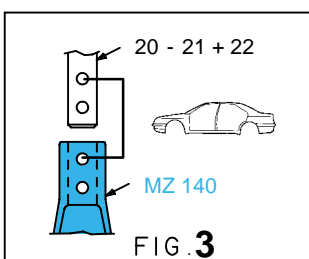
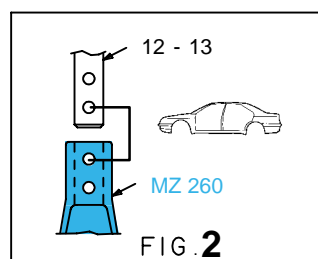
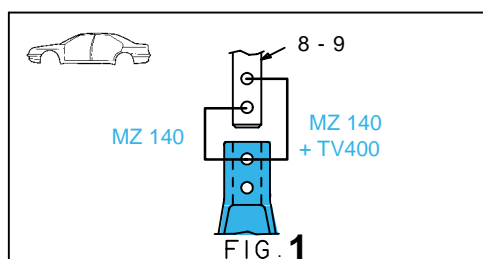
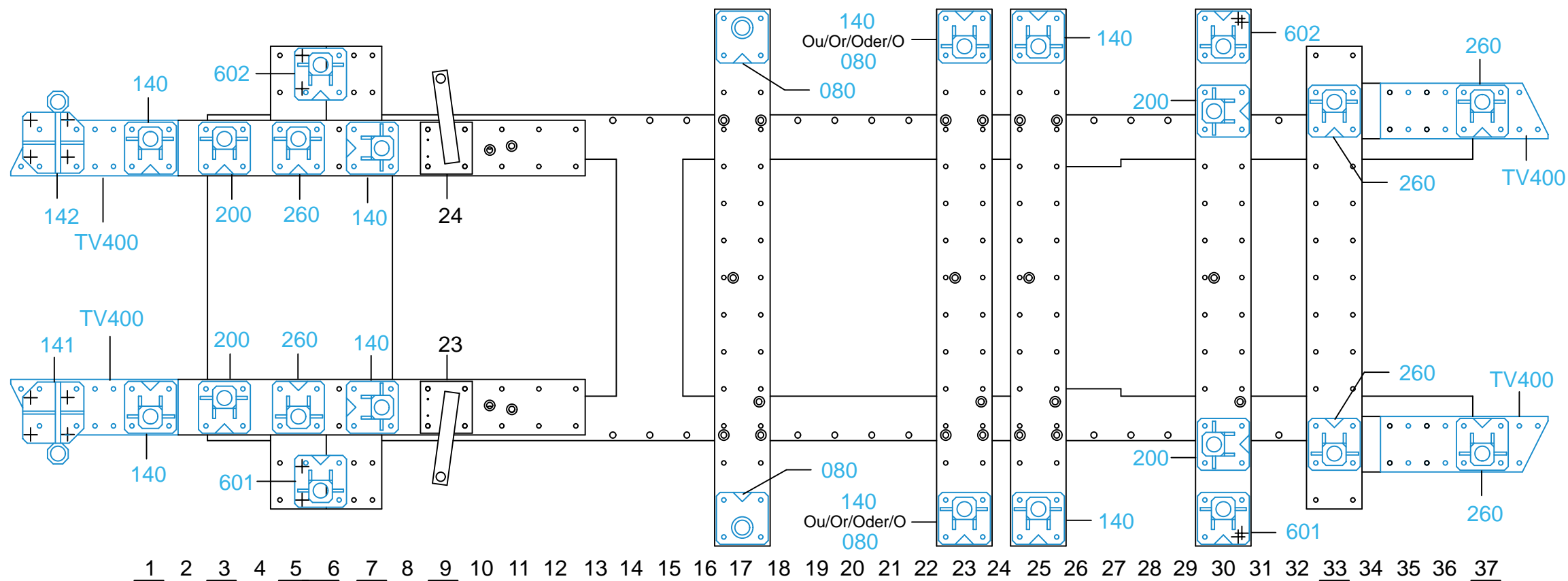
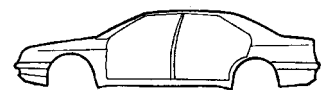

○ Avec ou sans mécanique
 With or without mechanical elements
 Con o senza parti meccaniche
 Mit oder ohne Aggregate
 Con ó sin mecanica desmontada

2035.304

6 Kg 06.04.2005 431-D-10C

2035.304-RVA3-2 00

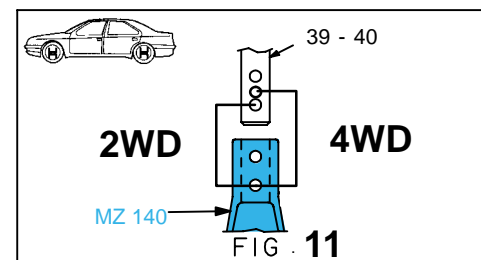
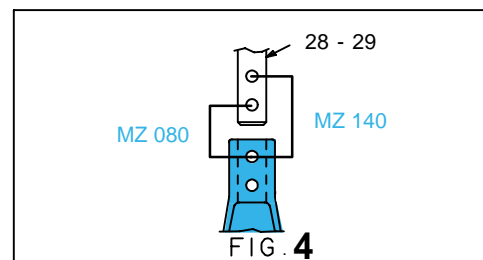
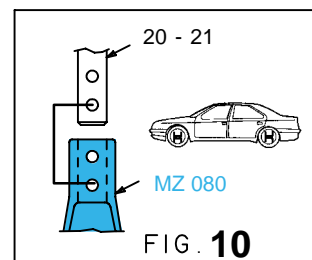
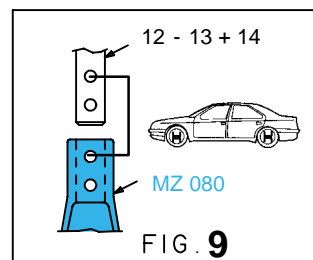
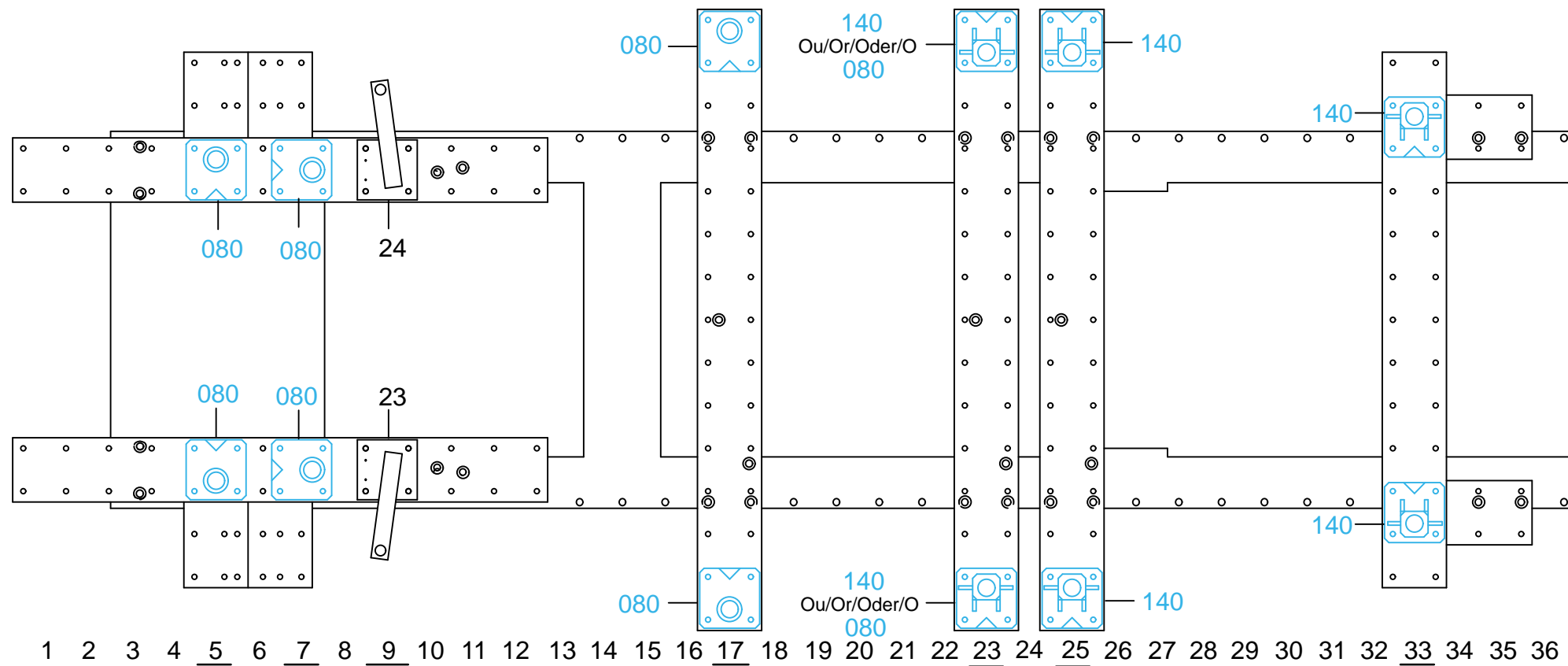
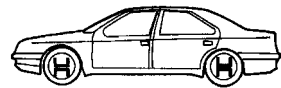

○ Avec ou sans mécanique
 With or without mechanical elements
 Con o senza parti meccaniche
 Mit oder ohne Aggregate
 Con ó sin mecánica desmontada

2035.304

6 Kg	06.04.2005	431-D-10D
2035.304 - RVA3-2		00