

* = 4 MOTION

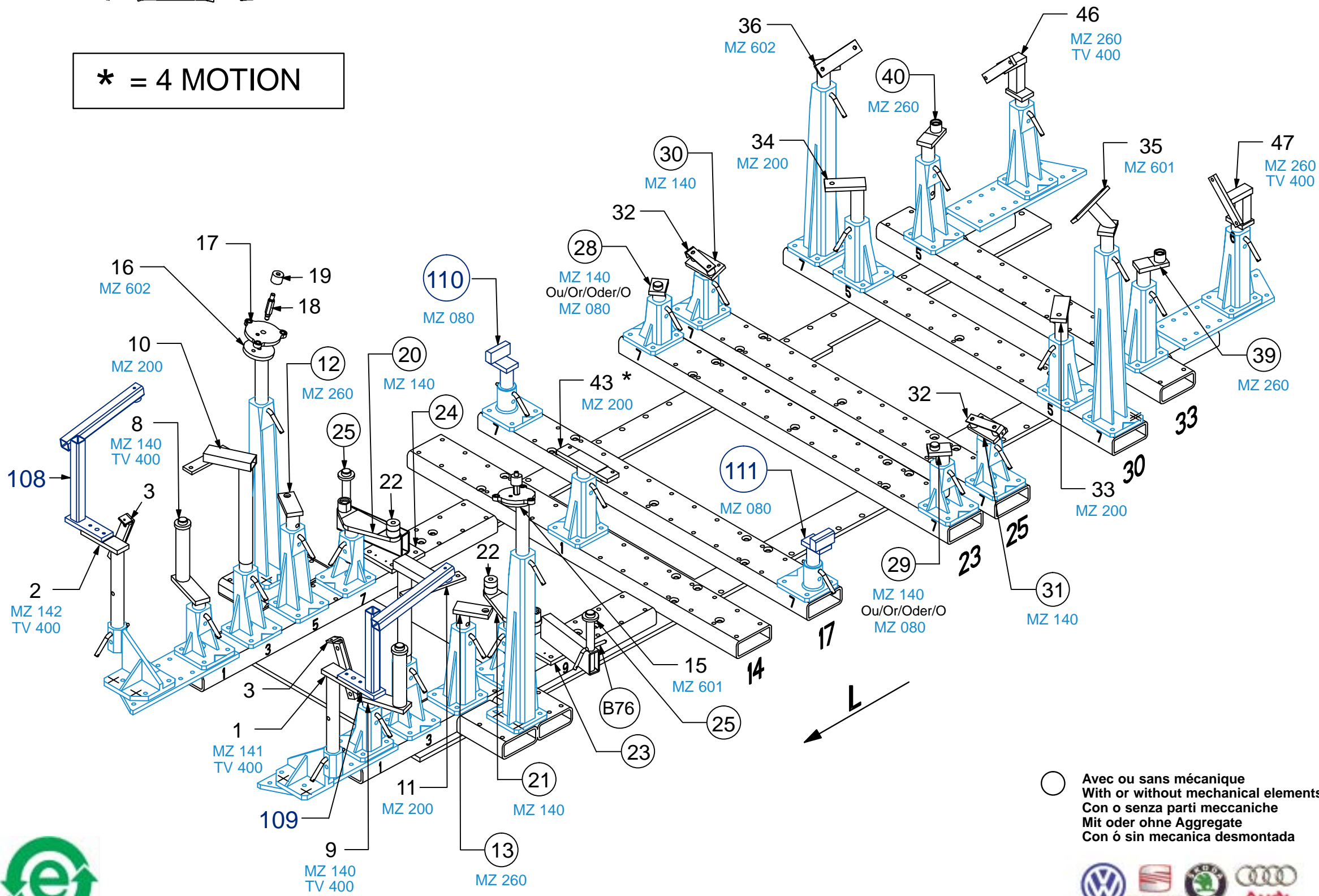

○ Avec ou sans mécanique
 With or without mechanical elements
 Con o senza parti meccaniche
 Mit oder ohne Aggregate
 Con ó sin mecanica desmontada



REP.	REFERENCE	PDS	NB	MZ
108	2010.7108	2,5	1	
109	2010.7109	2,5	1	
110	2010.7110	2,4	1	080
111	2010.7111	2,4	1	080

⚙ M 6-60 2

2035.300
 Ou/Or/Oder/O
 complément au
 complementary set to
 complemento al
 zusatz zu
2010.300 +
2010.309 +

2035.302

10 Kg 26.08.2008 438-D-28K

2035.302-RVA3-1 00



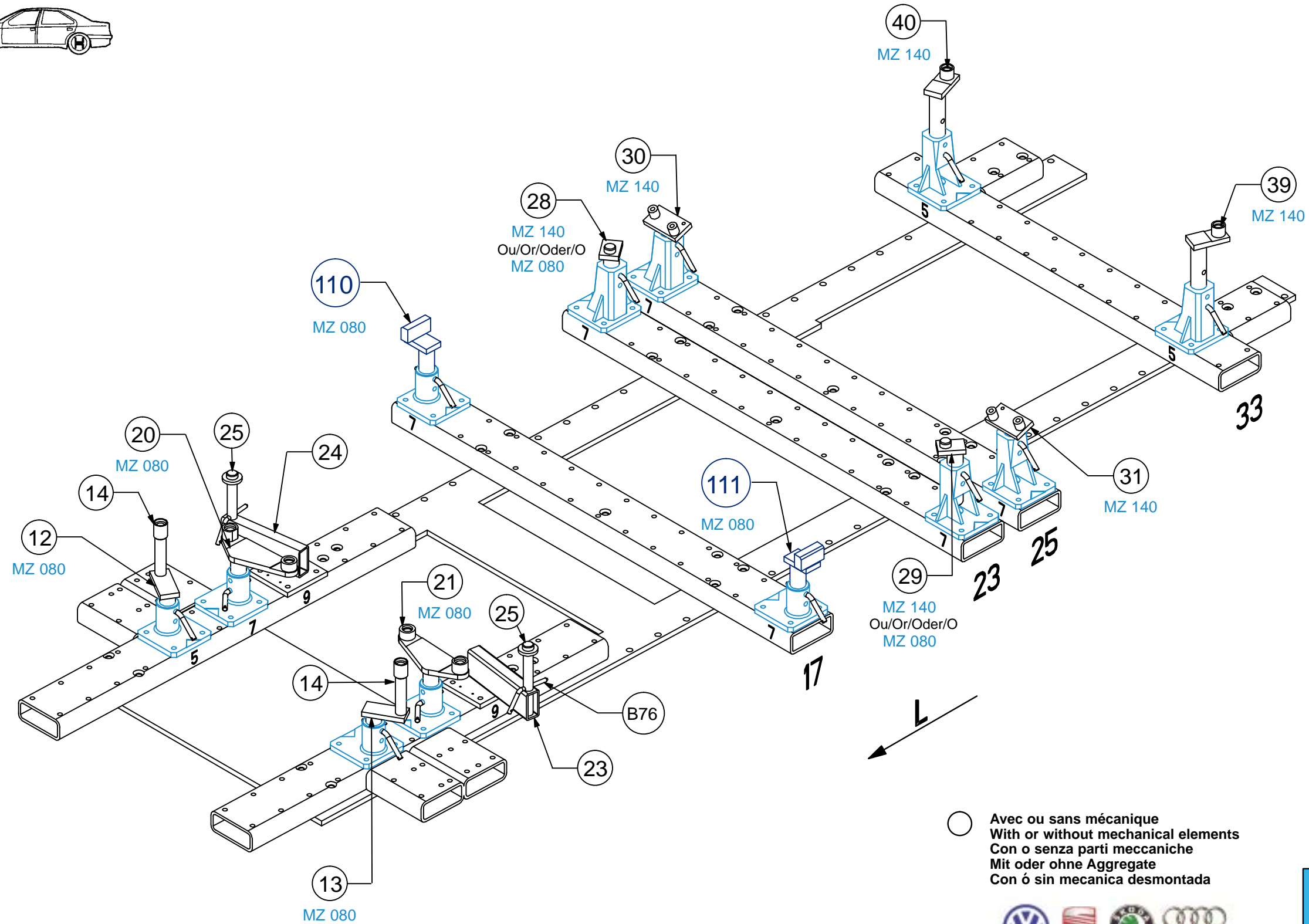
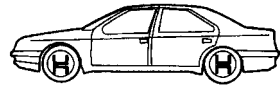

2035.302

10 Kg	10.06.2008	438-D-28L
2035.302-RVA3-1		00

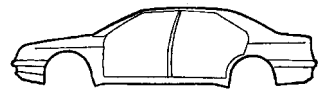

* = 4 MOTION

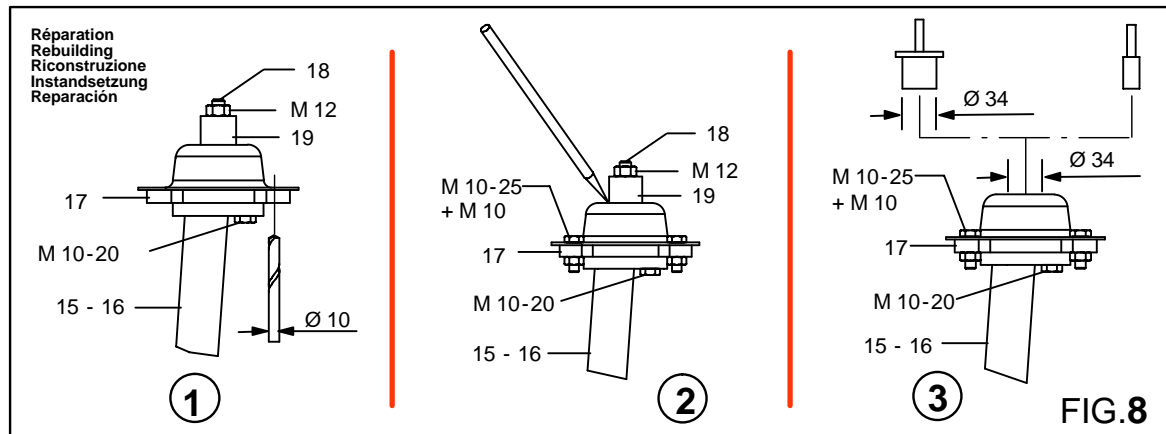
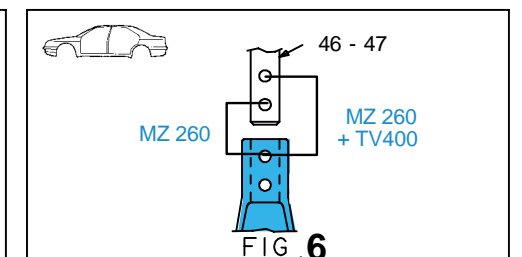
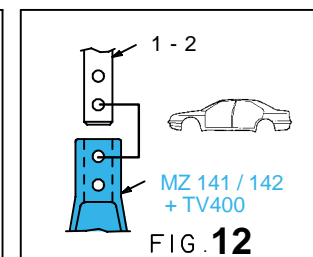
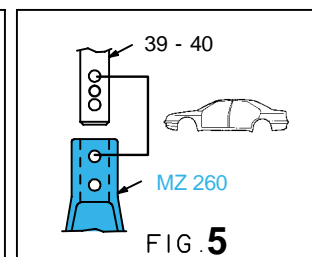
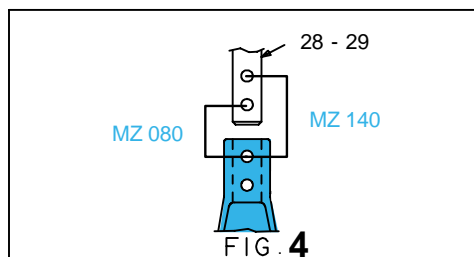
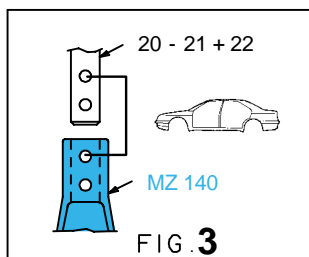
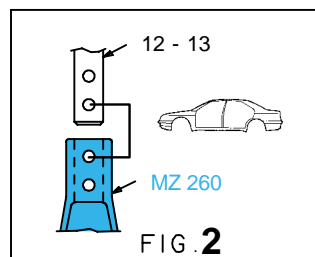
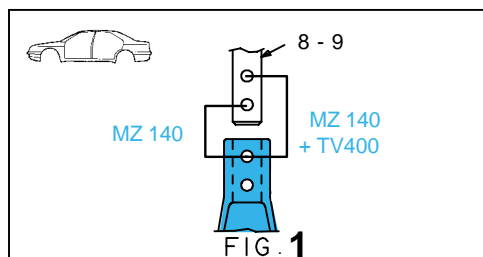
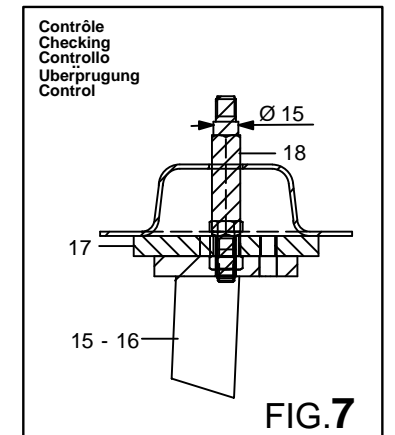
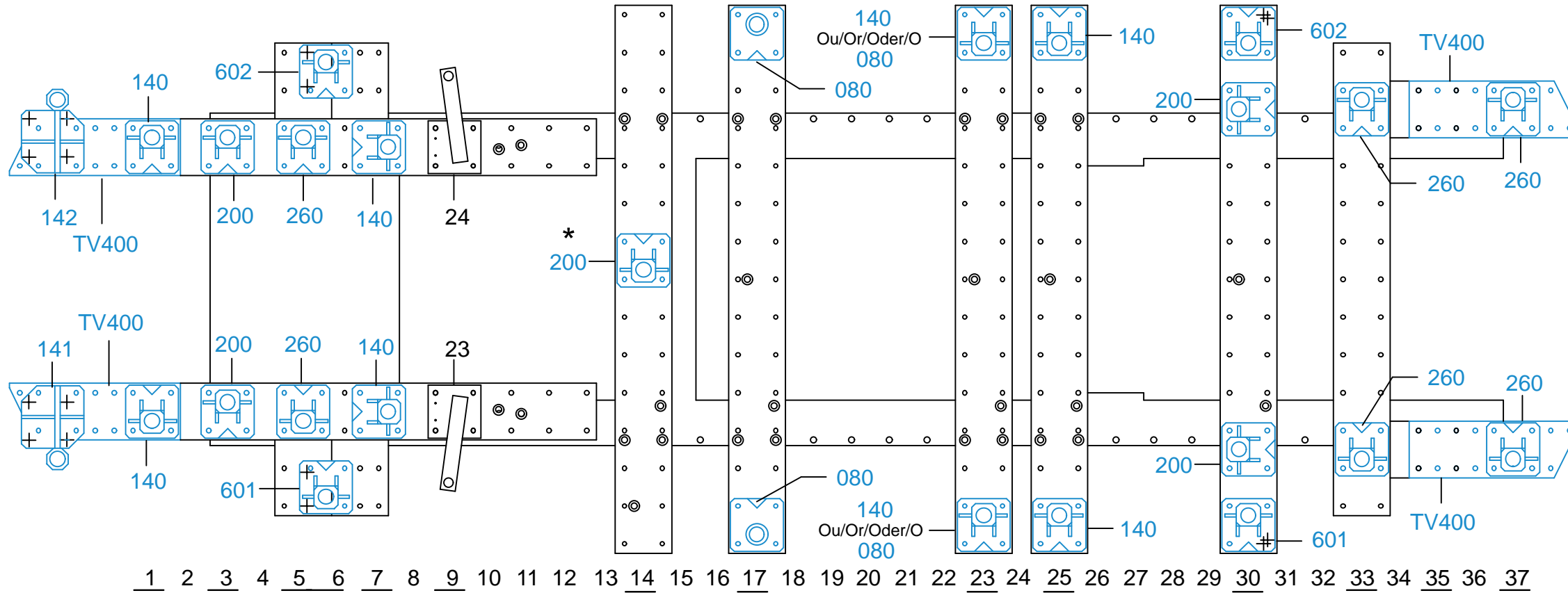

○ Avec ou sans mécanique
With or without mechanical elements
Con o senza parti meccaniche
Mit oder ohne Aggregate
Con ó sin mecanica desmontada



2035.302		
10 Kg	10.06.2008	438-D-28M
2035.302-RVA3-2		00

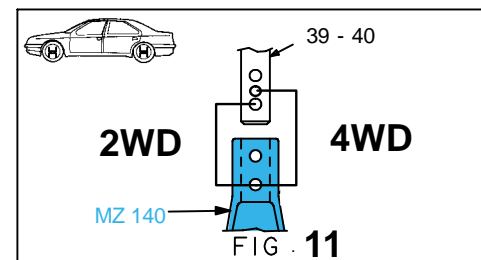
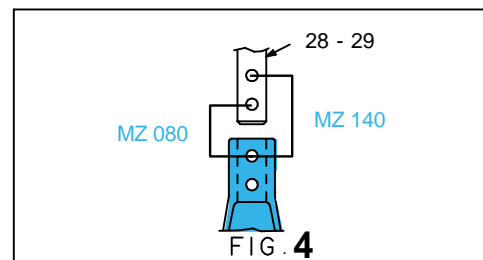
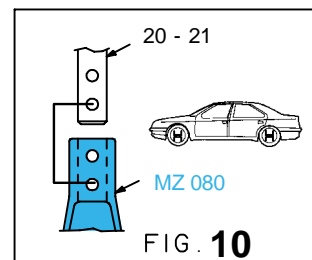
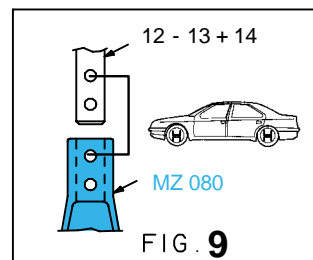
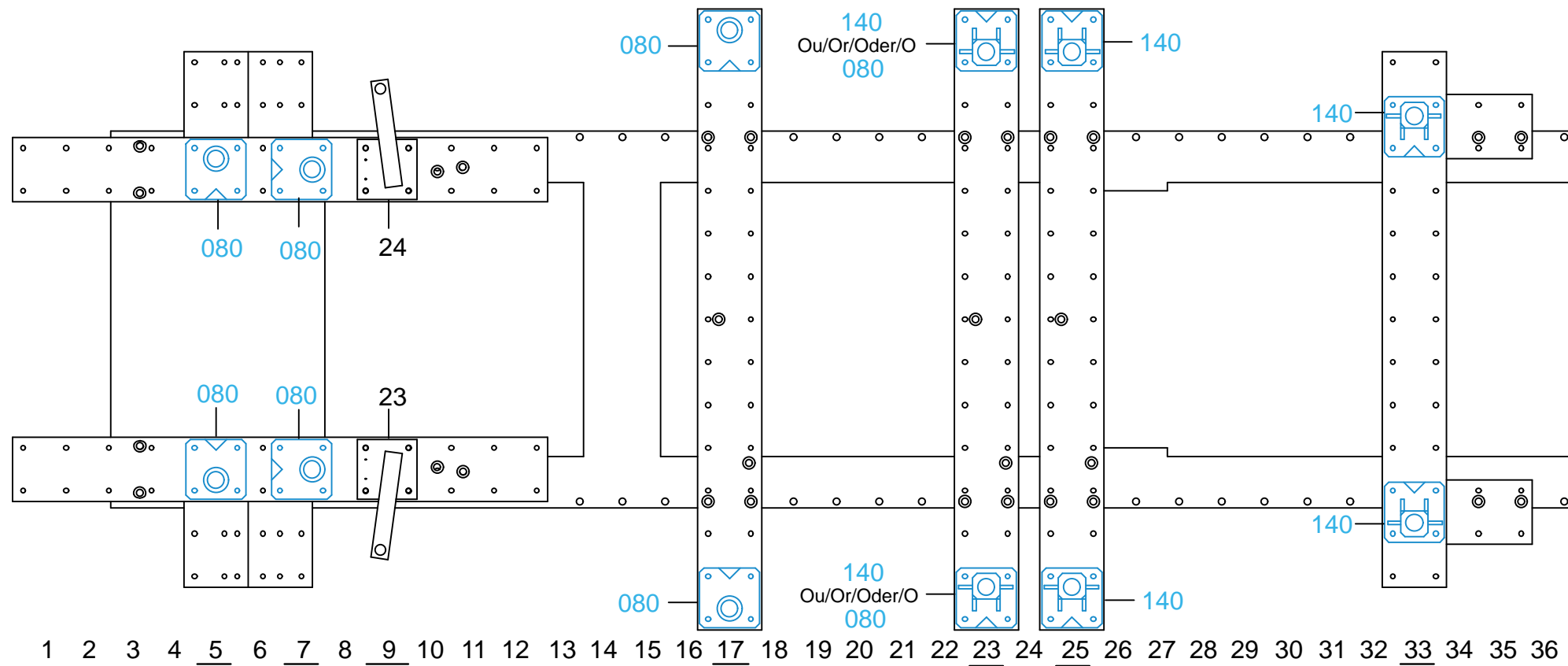
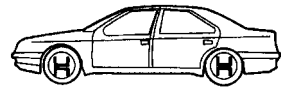

○ Avec ou sans mécanique
 With or without mechanical elements
 Con o senza parti meccaniche
 Mit oder ohne Aggregate
 Con ó sin mecanica desmontada



2035.302

10 Kg	10.06.2008	438-D-28N
2035.302-RVA3-2		00