

* = 4 MOTION

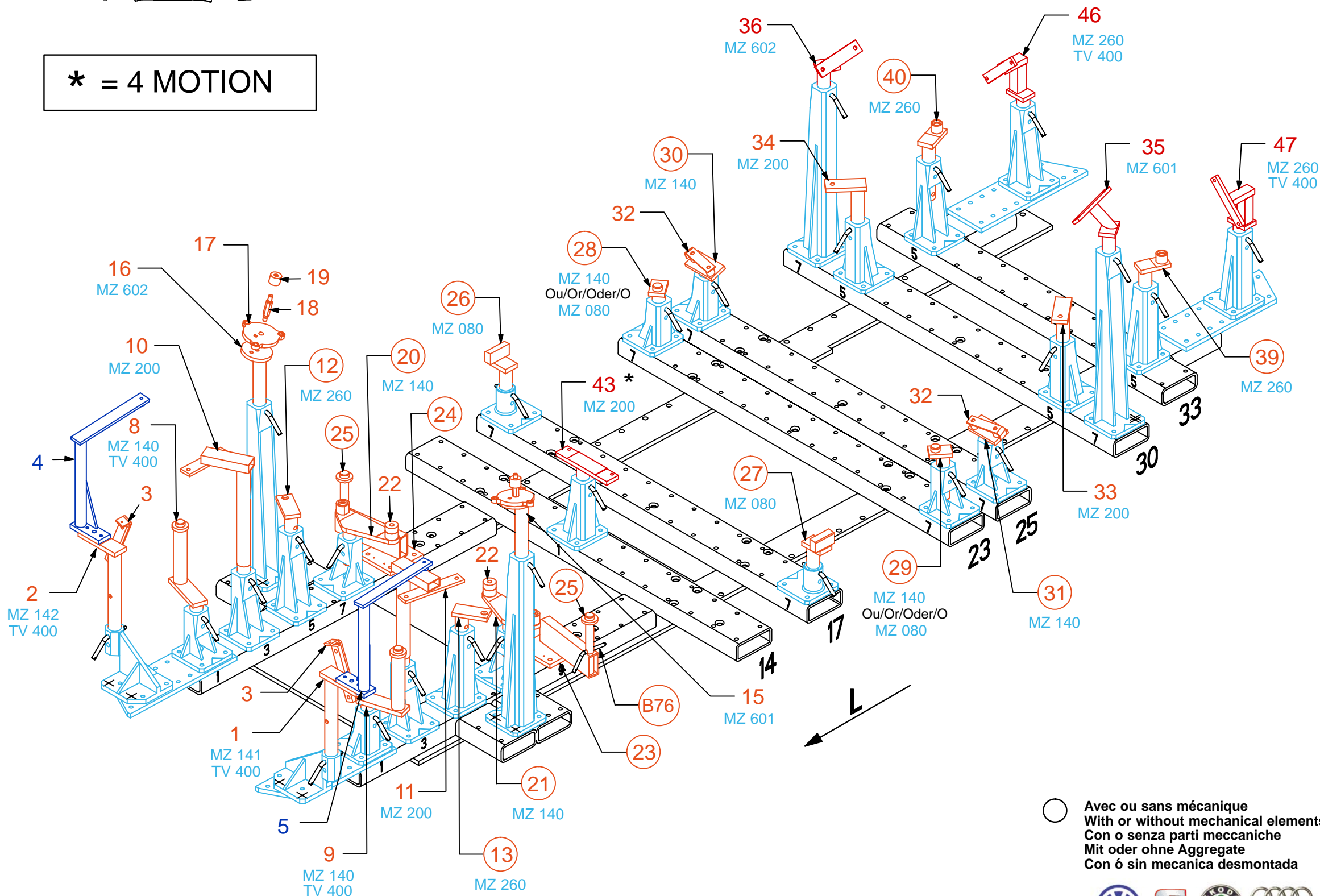

REP.	REFERENCE	PDS	NB	MZ
1	2010.7001	3,0	1	141
2	2010.7002	3,0	1	142
3	2010.7003	0,3	2	
4	2010.7004	2,5	1	
5	2010.7005	2,5	1	
8	2010.7008	2,6	1	140
9	2010.7009	2,6	1	140
10	2010.7010	2,9	1	200
11	2010.7011	2,9	1	200
12	2010.7012	1,6	1	260/080
13	2010.7013	1,6	1	260/080
14	2010.7014	0,8	2	
15	2010.7015	3,2	1	601
16	2010.7016	3,2	1	602
17	2010.7017	1,0	2	
18	2010.7018	0,2	2	
19	2010.7019	0,1	1	
20	2010.7020	3,3	1	140/080
21	2010.7021	3,3	1	140/080
22	2010.7022	0,2	2	
23	2010.7023	4,1	1	
24	2010.7024	4,1	1	
25	2010.7025	0,9	2	
26	2010.7026	2,4	1	080
27	2010.7027	2,4	1	080
28	2010.7028	2,0	1	140/080
29	2010.7029	2,0	1	140/080
30	2010.7030	2,0	1	140
31	2010.7031	2,0	1	140
32	2010.7032	0,1	2	
33	2010.7033	2,6	1	200
34	2010.7034	2,6	1	200
35	2010.7035	2,2	1	601
36	2010.7036	2,2	1	602
39	2010.7039	2,6	1	260/140
40	2010.7040	2,6	1	260/140
43	2010.7043	2,3	1	200
46	2010.7046	2,6	1	260
47	2010.7047	2,6	1	260
	B76	0,1	2	

M 6-35	2
M 8-25	6
M 10-20	6
M 10-25	10
M 10-35	4
M 10-60	4
M 12-20	4
M 12x1,50-30	4
M 12x1,50-60	4
M 12x1,50-70	2
M 12x1,50-110	4
M 12x1,50-130	2
M 12x1,50-150	2
M 10	6
M 12	1

○ Avec ou sans mécanique
 With or without mechanical elements
 Con o senza parti meccaniche
 Mit oder ohne Aggregate
 Con ó sin mecanica desmontada

2035.300

91 Kg | 08.12.2004 | 438-D-28A

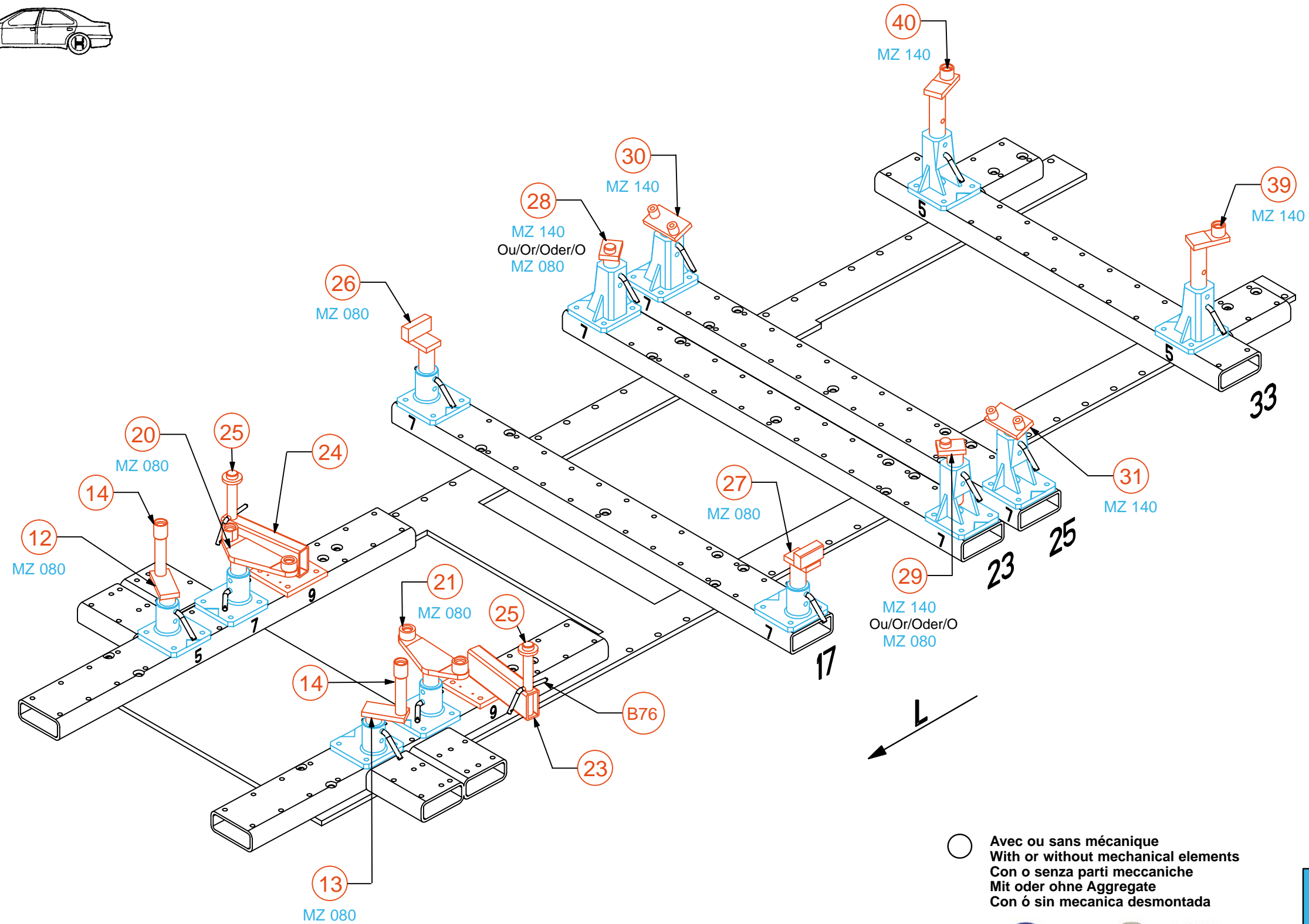

○ Avec ou sans mécanique
 With or without mechanical elements
 Con o senza parti meccaniche
 Mit oder ohne Aggregate
 Con ó sin mecanica desmontada

2035.300

91 Kg	29.09.2003	438-D-28B
2035.300-RVA3-1		01

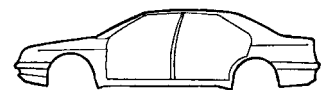

*** = 4 MOTION**

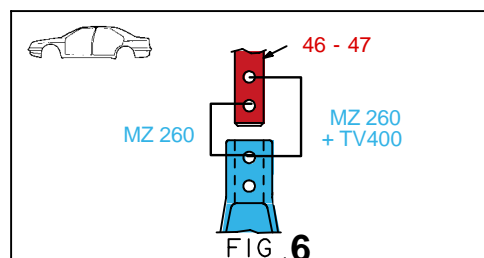
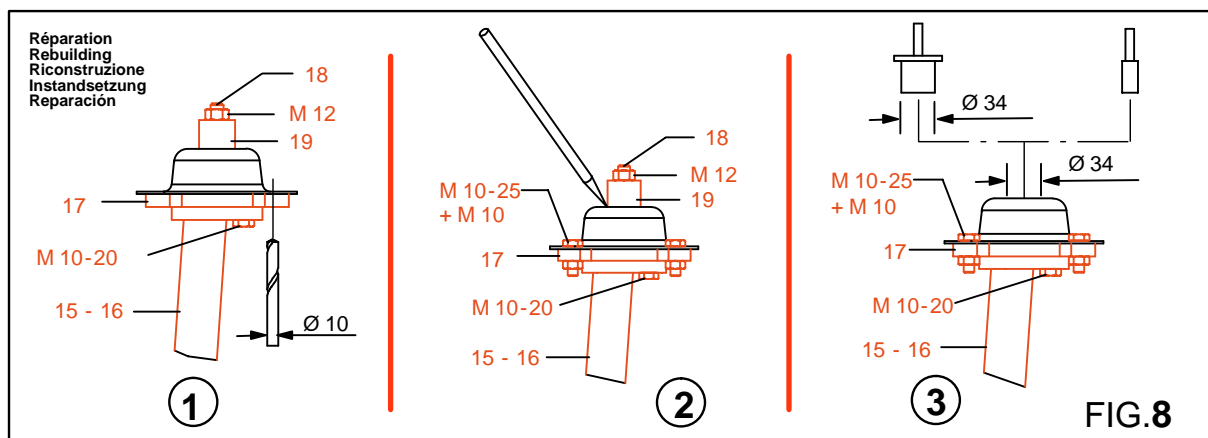
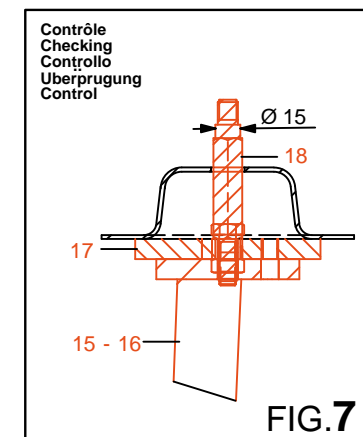
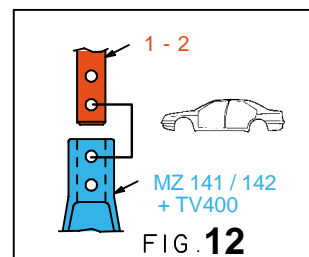
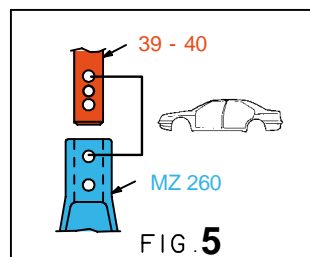
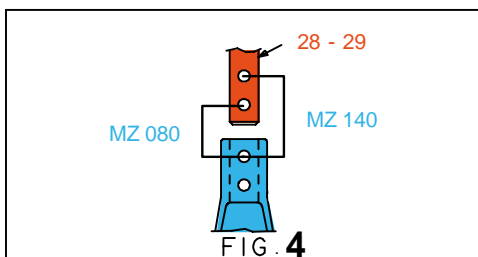
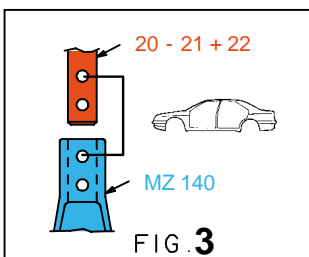
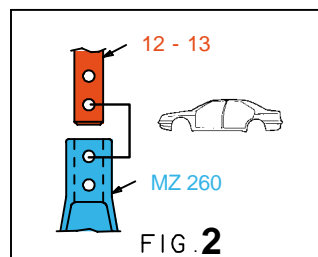
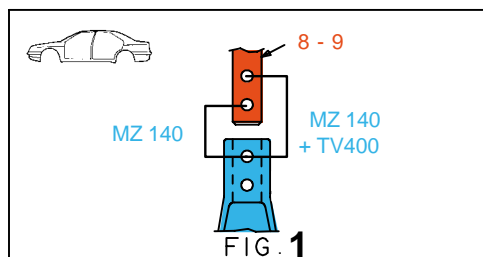
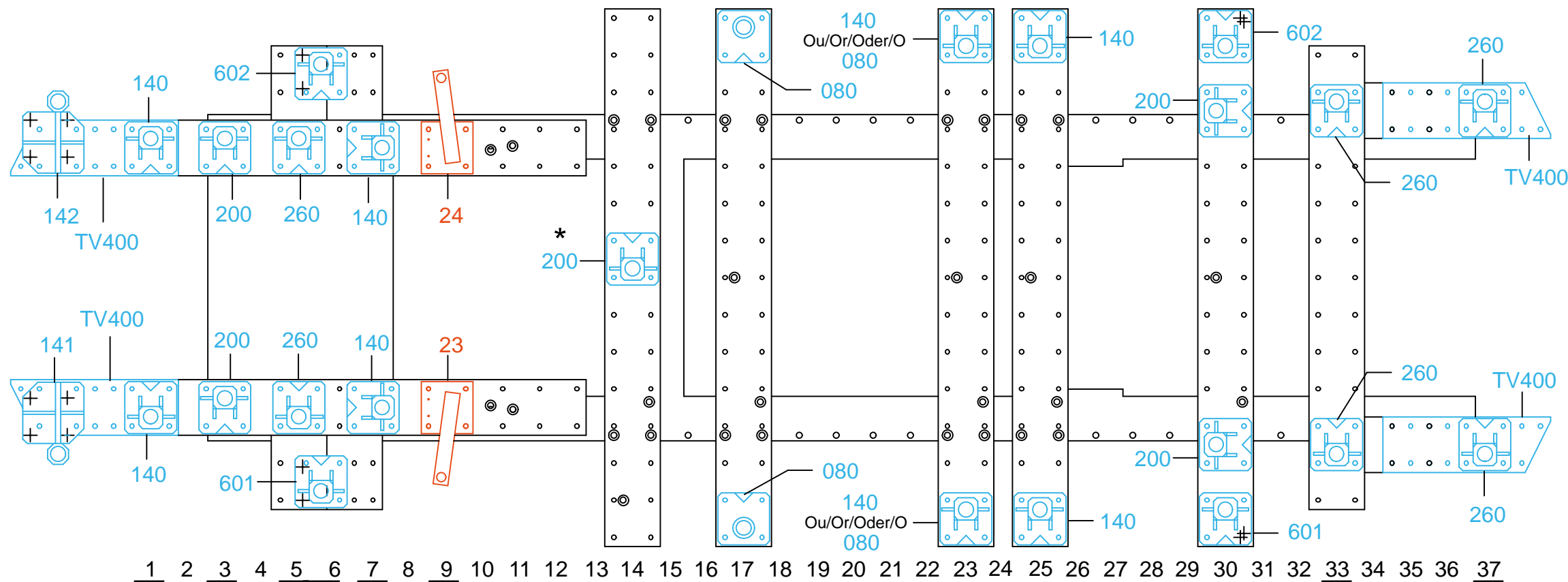

○ Avec ou sans mécanique
 With or without mechanical elements
 Con o senza parti meccaniche
 Mit oder ohne Aggregate
 Con ó sin mecanica desmontada

2035.300

91 Kg | 29.09.2003 | 438-D-28C

2035.300-RVA3-2 | 00

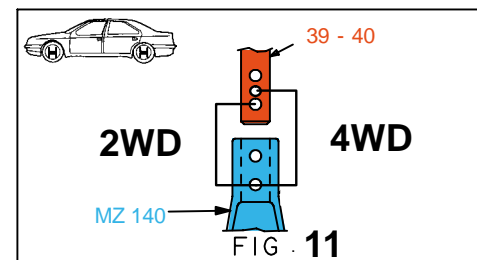
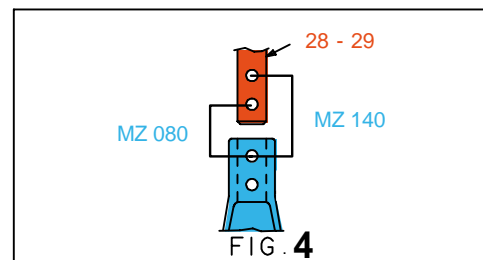
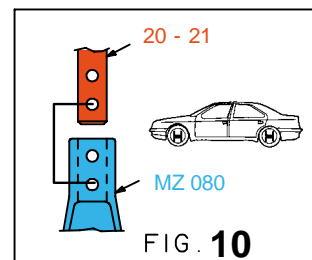
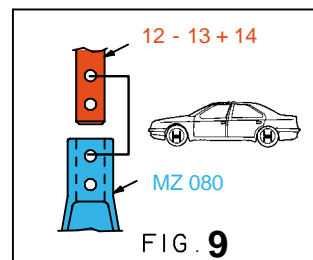
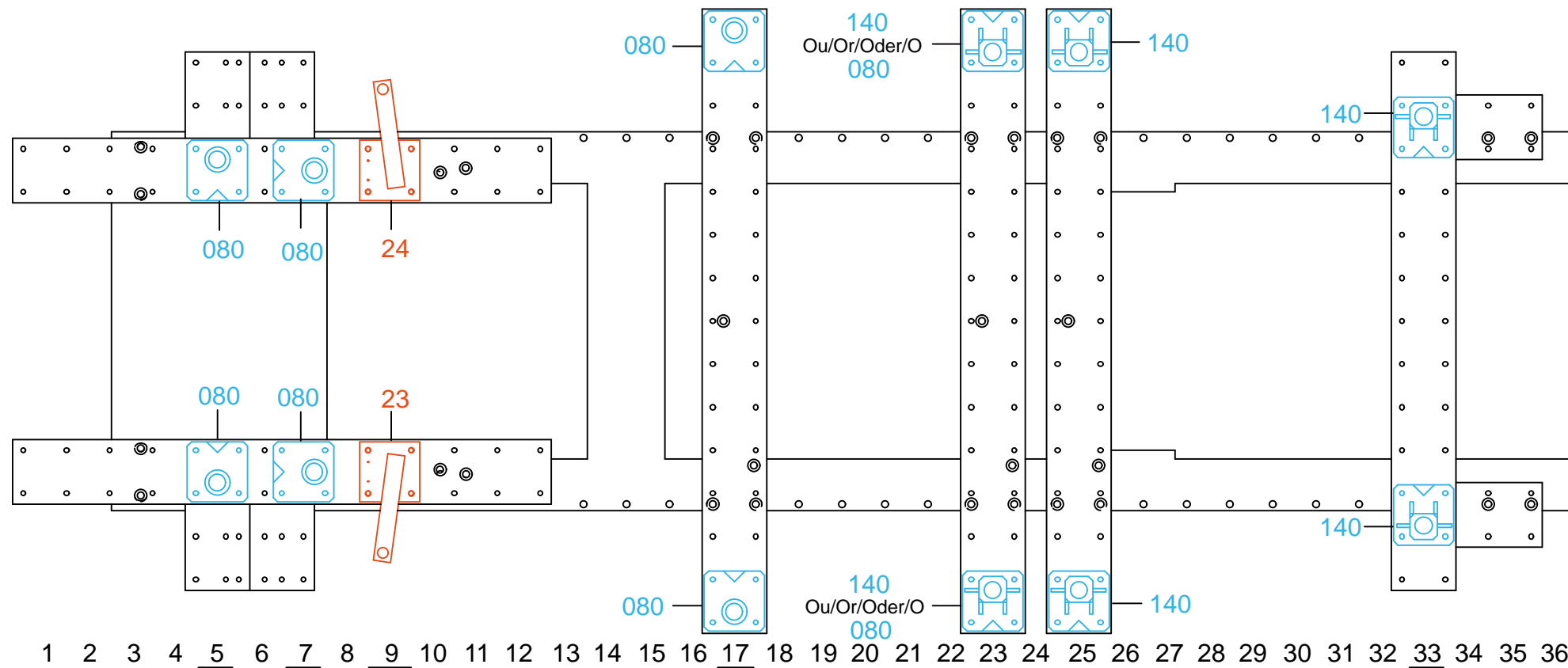
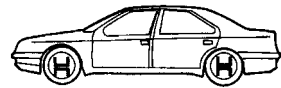

○ Avec ou sans mécanique
With or without mechanical elements
Con o senza parti meccaniche
Mit oder ohne Aggregate
Con ó sin mecanica desmontada



2035.300

91 Kg	29.09.2003	438-D-28D
2035.300-RVA3-2		00