

○ Avec ou sans mécanique
 With or without mechanical elements
 Con o senza parti meccaniche
 Mit oder ohne Aggregate
 Con ó sin mecanica desmontada

MITSUBISHI

REP.	REFERENCE	PDS	NB	MZ
34	2030.7034	2,7	1	200
35	2030.7035	2,7	1	200
36	2030.7036	3,4	1	142
37	2030.7037	3,4	1	141
55	2030.7055	3,0	1	601
56	2030.7056	3,0	1	602
57	2030.7057	0,6	2	
59	2030.7059	0,2	2	
61	2030.7061	2,3	1	260
62	2030.7062	2,3	1	260

M 10x1,25-50 2
 M 12x1,25-200 2

complément au
 complementary set to
 complemento al
 zusatz zu **2030.300**

2030.309

25 Kg 18.05.2005 421-D-32C

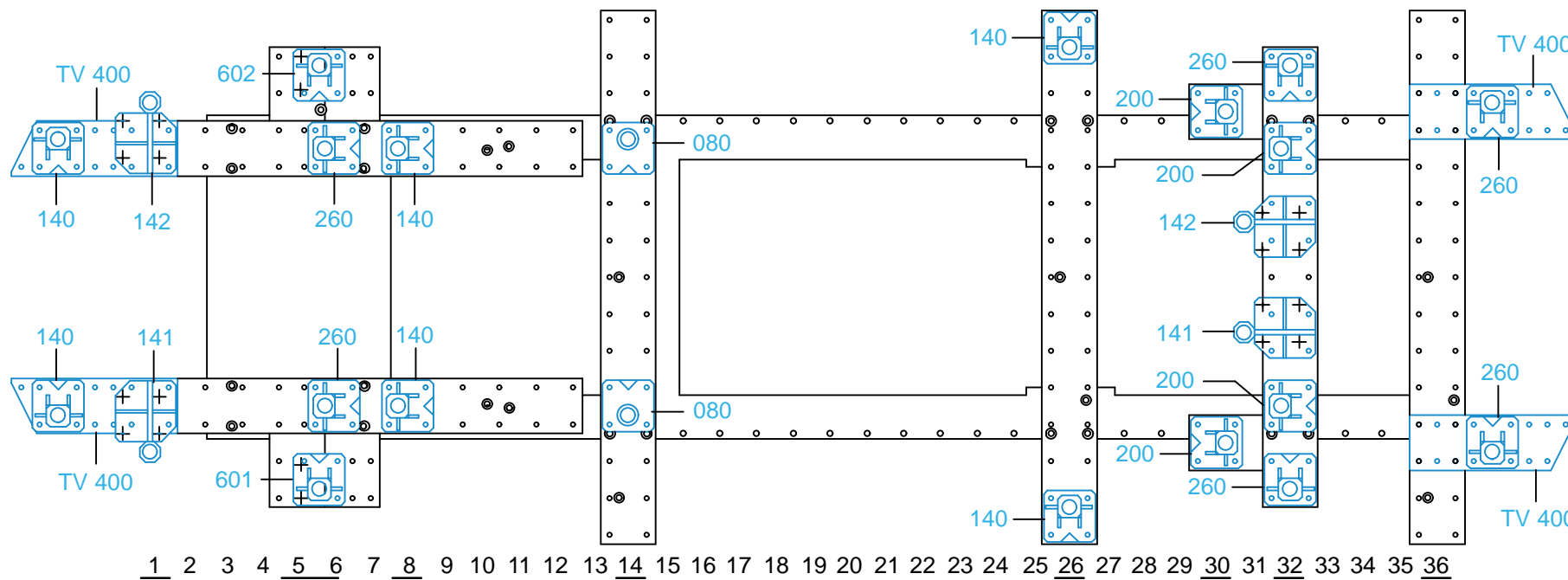

1 2 3 4 5 6 7 8 9 10 11 12 13 14 15 16 17 18 19 20 21 22 23 24 25 26 27 28 29 30 31 32 33 34 35 36

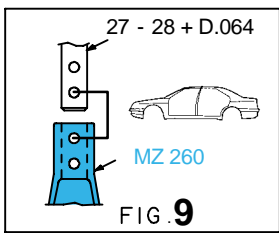
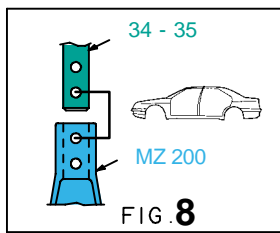
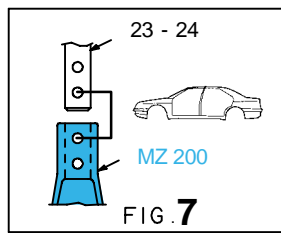
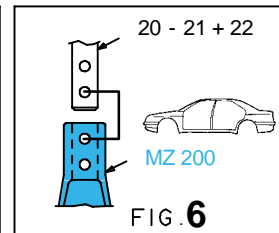
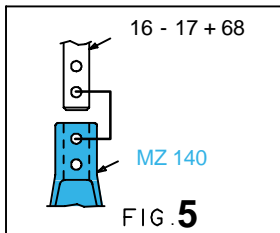
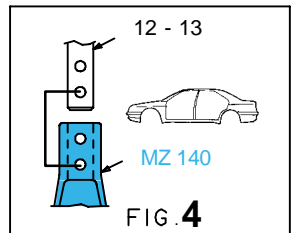
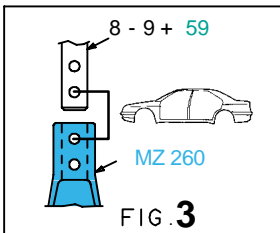
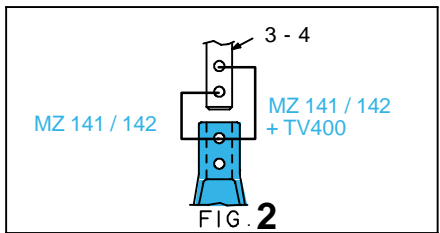
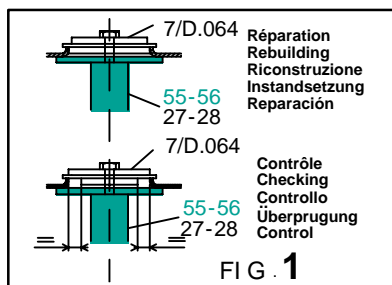

2030.309-RVA3-1 00

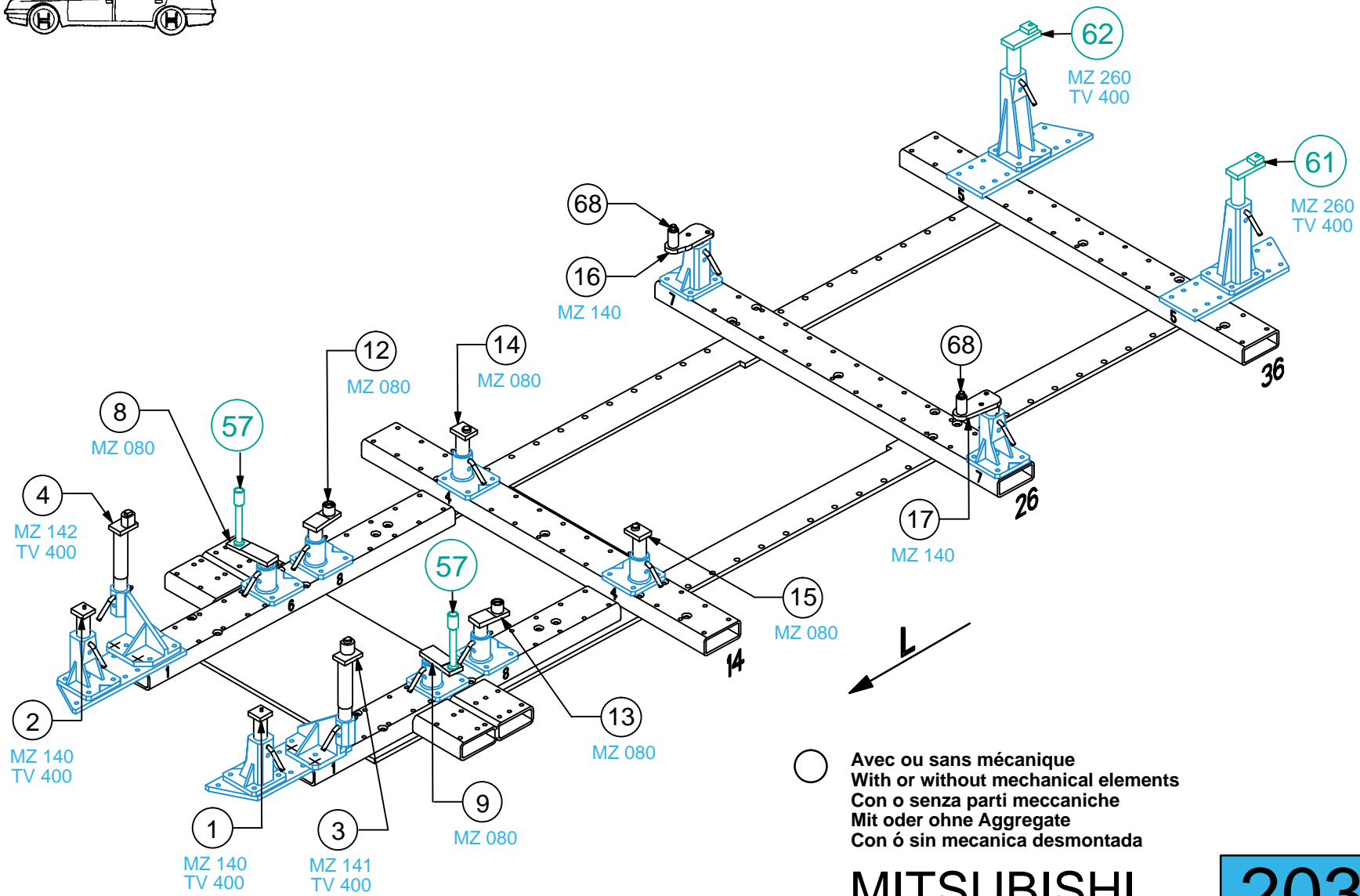

2030.309
25 Kg | 18.05.2005 | 421-D-32D

