

**AVEC BERCEAU ARRIERE
WITH REAR CRADLE
MIT HINTERACHSKÖRPER
CON TELAIO POSTERIORE
CON BASTIDOR TRASERO**

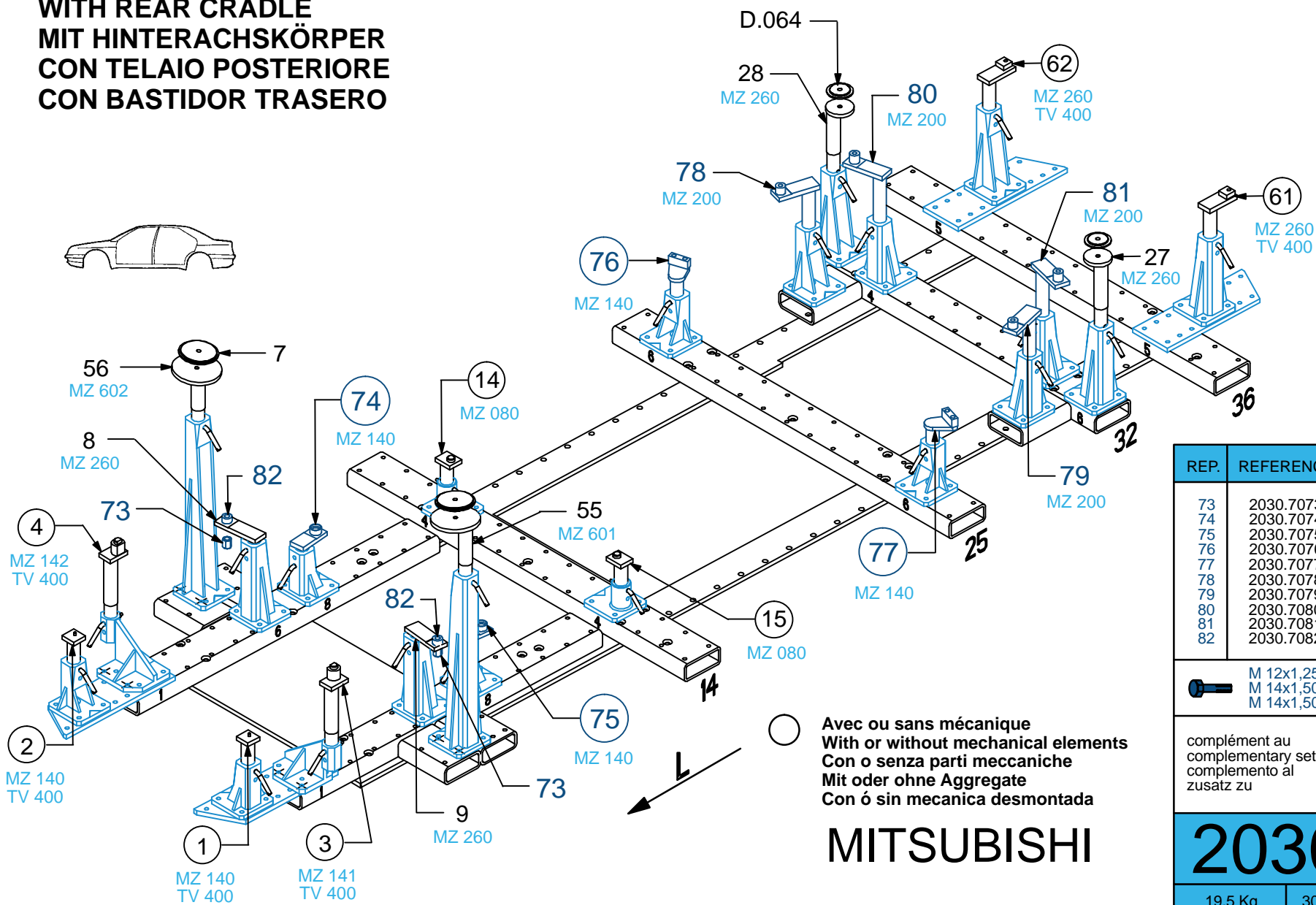

| REP. | REFERENCE | PDS | NB | MZ |
|------|-----------|------|----|---------|
| 73 | 2030.7073 | 0,01 | 2 | 140/080 |
| 74 | 2030.7074 | 1,5 | 1 | 140/080 |
| 75 | 2030.7075 | 1,5 | 1 | 140 |
| 76 | 2030.7076 | 1,8 | 1 | 140 |
| 77 | 2030.7077 | 1,8 | 1 | 140 |
| 78 | 2030.7078 | 2,9 | 1 | 200 |
| 79 | 2030.7079 | 2,9 | 1 | 200 |
| 80 | 2030.7080 | 3,1 | 1 | 200 |
| 81 | 2030.7081 | 3,1 | 1 | 200 |
| 82 | 2030.7082 | 0,1 | 2 | 200 |

| | |
|---------------|---|
| M 12x1,25-60 | 4 |
| M 14x1,50-100 | 2 |
| M 14x1,50-160 | 2 |

complément au
complementary set to
complemento al
zusatz zu

**2030.300 +
2030.309**

MITSUBISHI

2030.306

| | | |
|---------|------------|-----------|
| 19,5 Kg | 30.11.2005 | 421-D-32K |
|---------|------------|-----------|

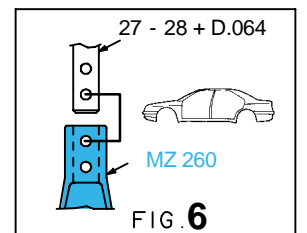
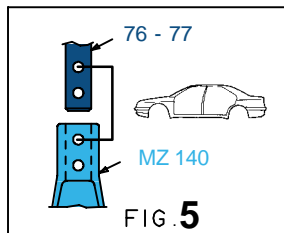
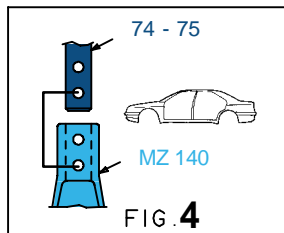
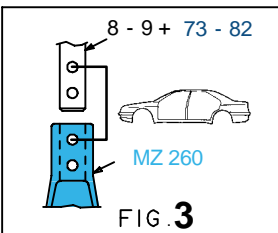
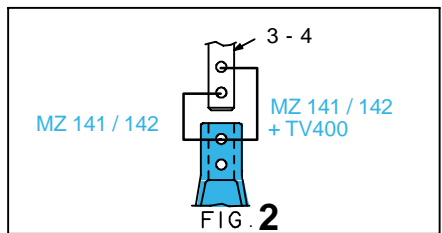
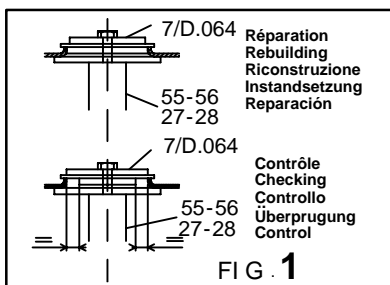
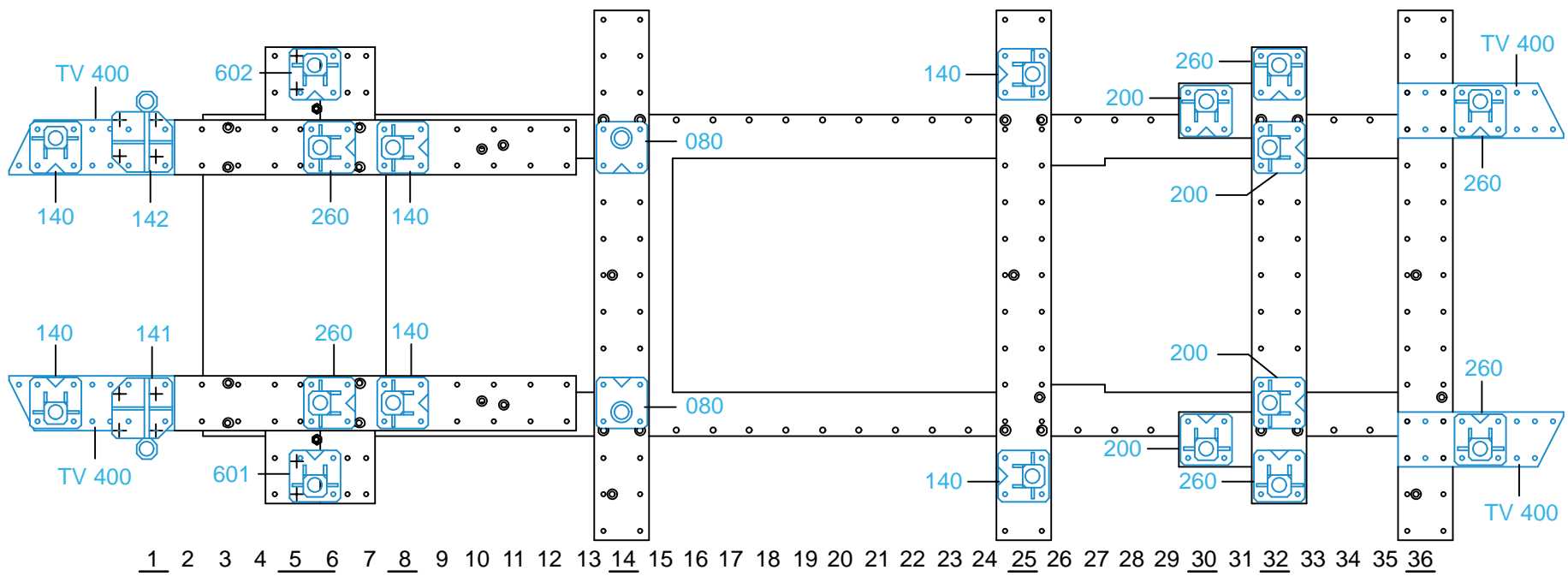

2030.306-RVA3-1 00

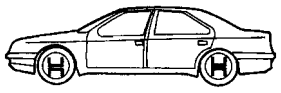

**AVEC BERCEAU ARRIERE
WITH REAR CRADLE
MIT HINTERACHSKÖRPER
CON TELAIO POSTERIORE
CON BASTIDOR TRASERO**

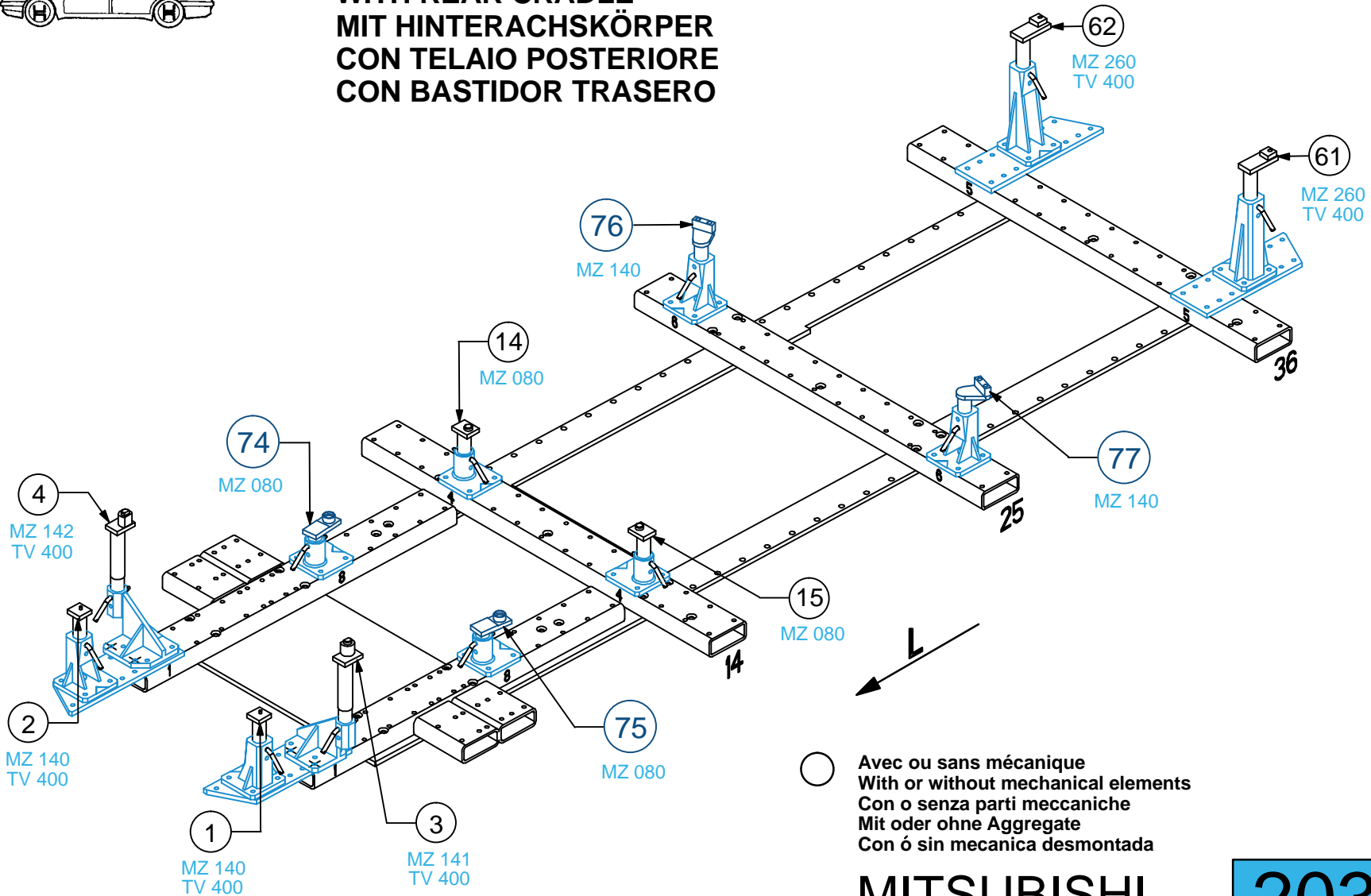

○ Avec ou sans mécanique
With or without mechanical elements
Con o senza parti meccaniche
Mit oder ohne Aggregate
Con ó sin mecanica desmontada

MITSUBISHI

2030.306

19,5 Kg | 30.11.2005 | 421-D-32L

