

○ Avec ou sans mécanique
 With or without mechanical elements
 Con o senza parti meccaniche
 Mit oder ohne Aggregate
 Con ó sin mecanica desmontada

REP.	REFERENCE	PDS	NB	MZ
43	2026.7043	2,8	1	200
44	2026.7044	2,8	1	200

complément au
 complementary set to
 complemento al
 zusatz zu **2026.300**

2026.308
 6 Kg | 29.08.2006 | 439-D-13E

VOLVO

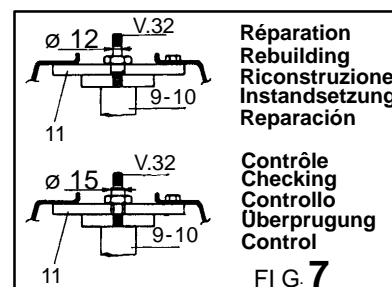
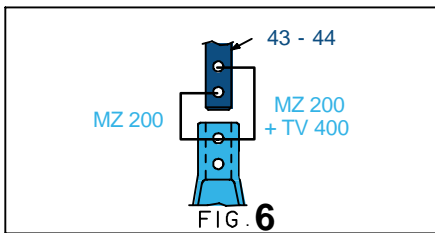
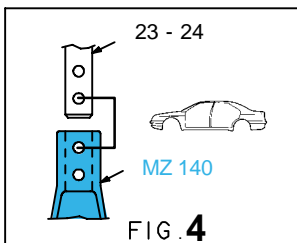
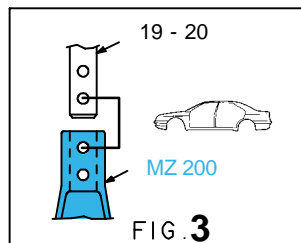
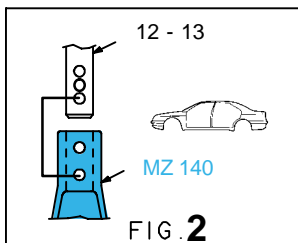
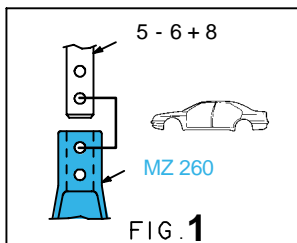
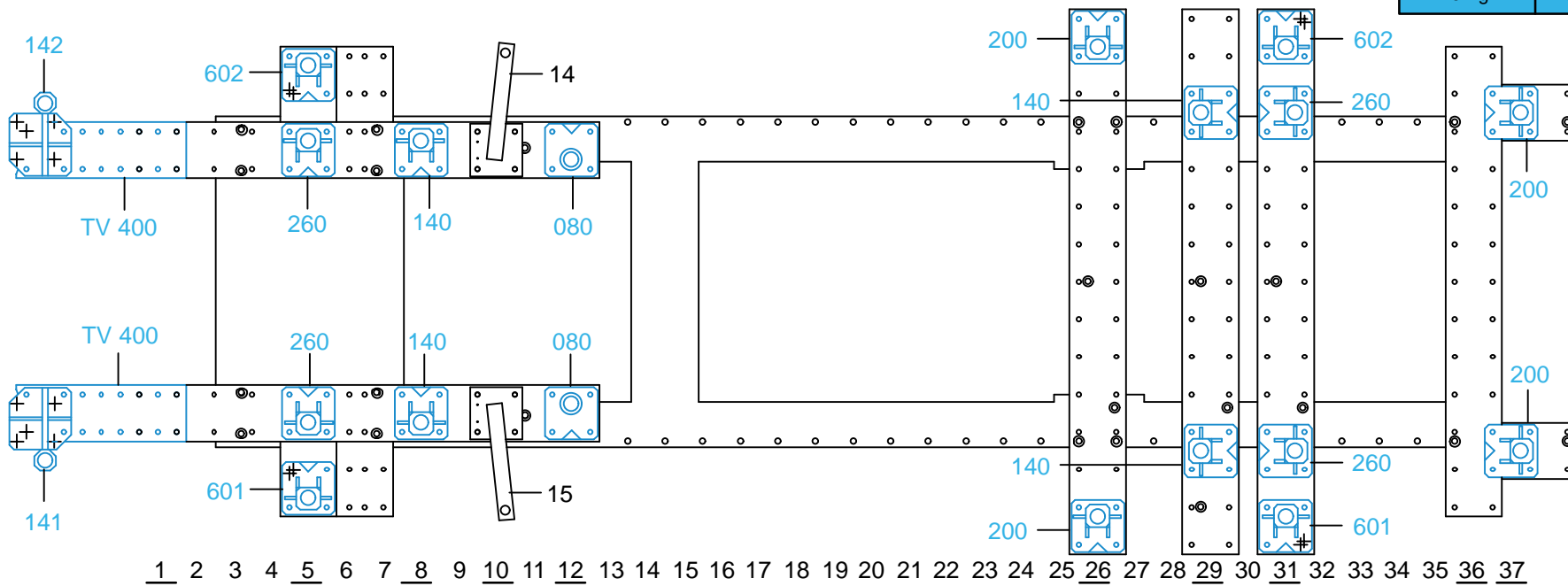

2026.308-RVA3-1 | 00

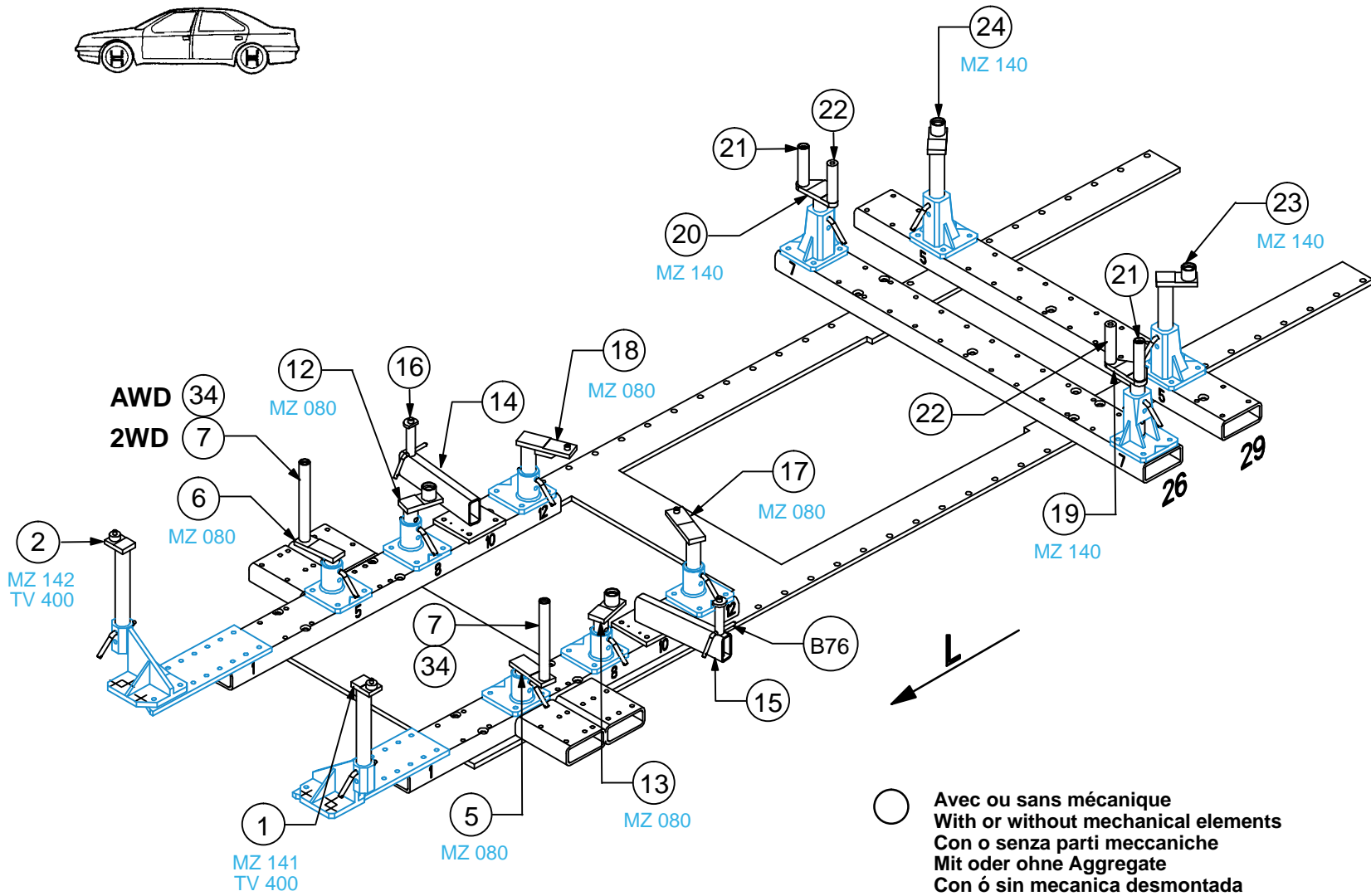

○ Avec ou sans mécanique
 With or without mechanical elements
 Con o senza parti meccaniche
 Mit oder ohne Aggregate
 Con ó sin mecanica desmontada

VOLVO

2026.308

6 Kg	29.08.2006	439-D-13F
------	------------	-----------

