

REP.	REFERENCE	PDS	NB	MZ
1	2024.7001	2,2	1	260
2	2024.7002	2,2	1	260
3	2024.7003	1,7	1	260
4	2024.7004	1,7	1	260
5	2024.7005	2,3	1	080
6	2024.7006	2,3	1	080
7	2024.7007	0,2	2	
8	2024.7008	2,1	1	602
9	2024.7009	2,1	1	601
10	2024.7010	2,1	1	140
11	2024.7011	2,1	1	140
12	2024.7012	0,1	2	
13	2024.7013	1,7	1	141
14	2024.7014	1,7	1	142
15	2024.7015	3,1	1	080
16	2024.7016	3,1	1	080
17	2024.7017	2,4	1	080
18	2024.7018	2,4	1	080
19	2024.7019	1,1	1	
20	2024.7020	1,1	1	
21	2024.7021	1,1	1	
22	2024.7022	1,1	1	
23	2024.7023	2,7	1	200
24	2024.7024	2,7	1	200
25	2024.7025	2,0	1	200
26	2024.7026	2,0	1	260
27	2024.7027	2,0	1	260
28	2024.7028	2,9	2	
29	2024.7029	2,7	1	
30	2024.7030	2,7	1	
31	2024.7031	3,6	1	
32	2024.7032	3,0	2	
	E33	0,1	2	

M 10-45	2
M 12-25	28
M 12-30	8
M 12-45	4
M 12-110	4
M 10x1,25-100	2
M 12x1,25-50	2
CHc TB 12-25	18
M 10	14
M 12	4
LU 10	4

○ Avec ou sans mécanique
With or without mechanical elements
Con o senza parti meccaniche
Mit oder ohne Aggregate
Con ó sin mecanica desmontada

TOYOTA / LEXUS

2024.300

76 Kg 22.10.2003 434-D-79A

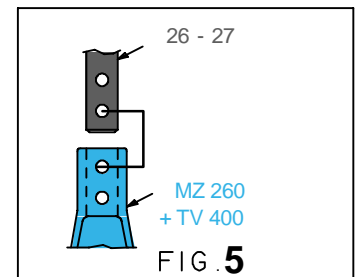
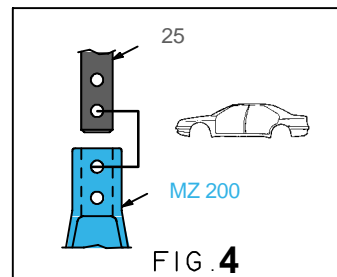
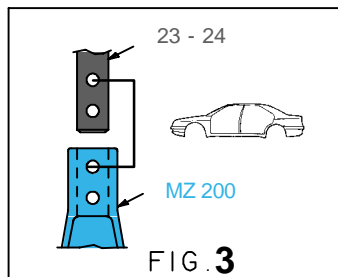
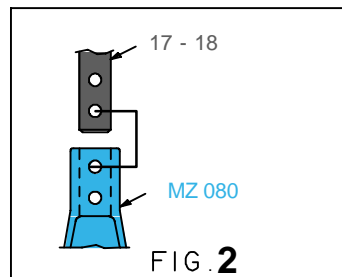
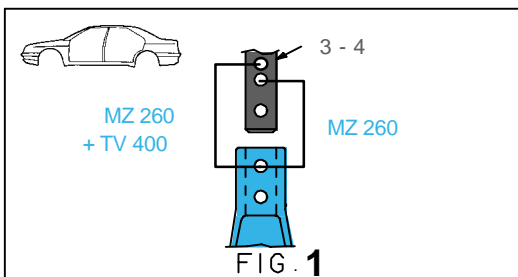
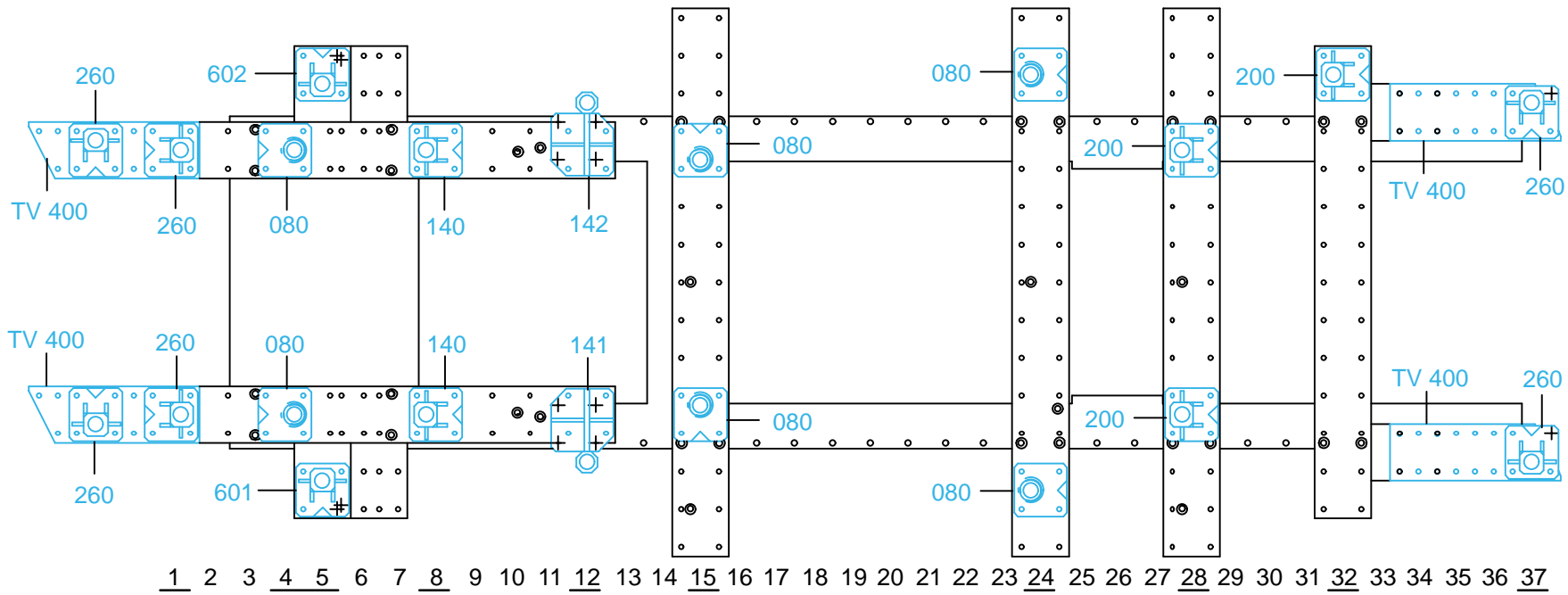

2024.300-RVA3-1 | 00

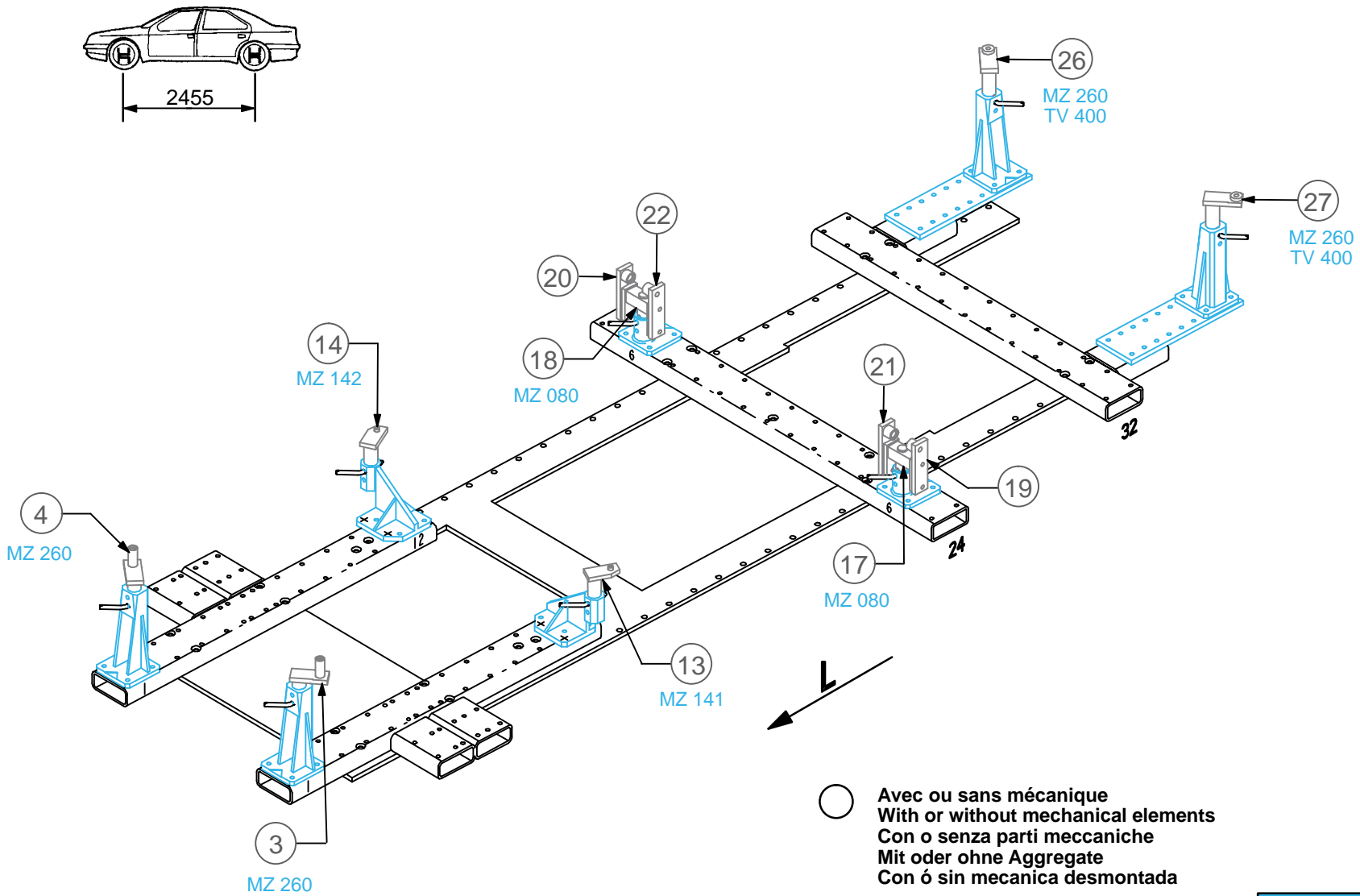

TOYOTA / LEXUS

2024.300

76 Kg | 22.10.2003 | 434-D-79B

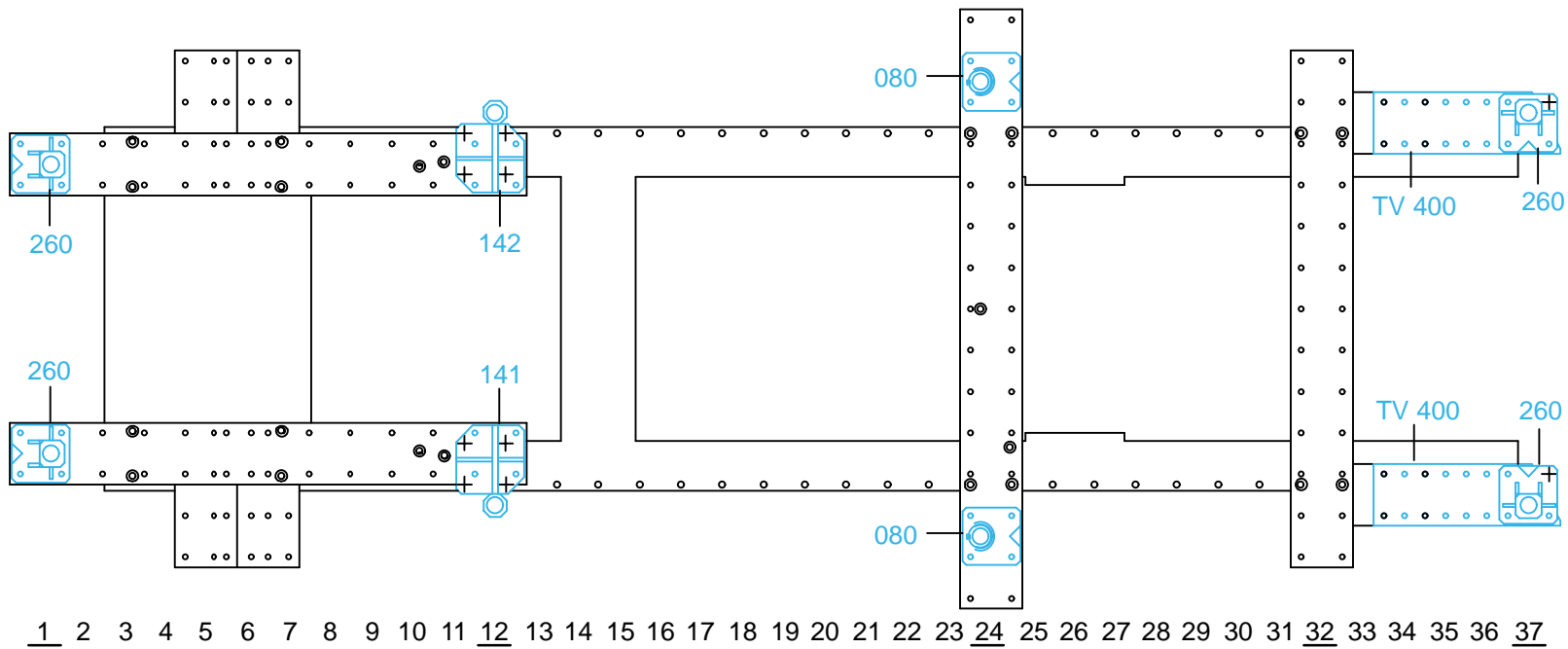

1 2 3 4 5 6 7 8 9 10 11 12 13 14 15 16 17 18 19 20 21 22 23 24 25 26 27 28 29 30 31 32 33 34 35 36 37

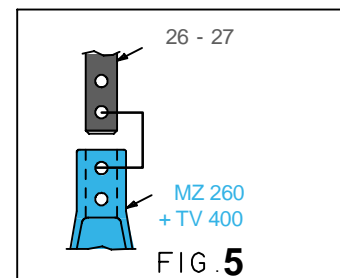
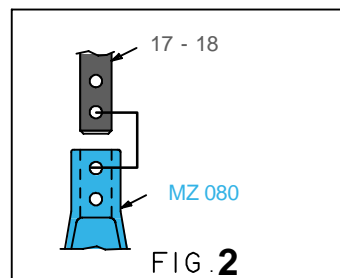
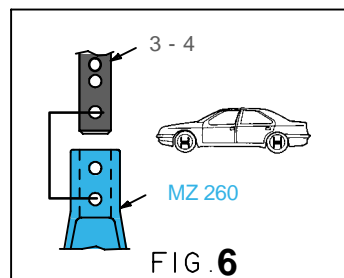

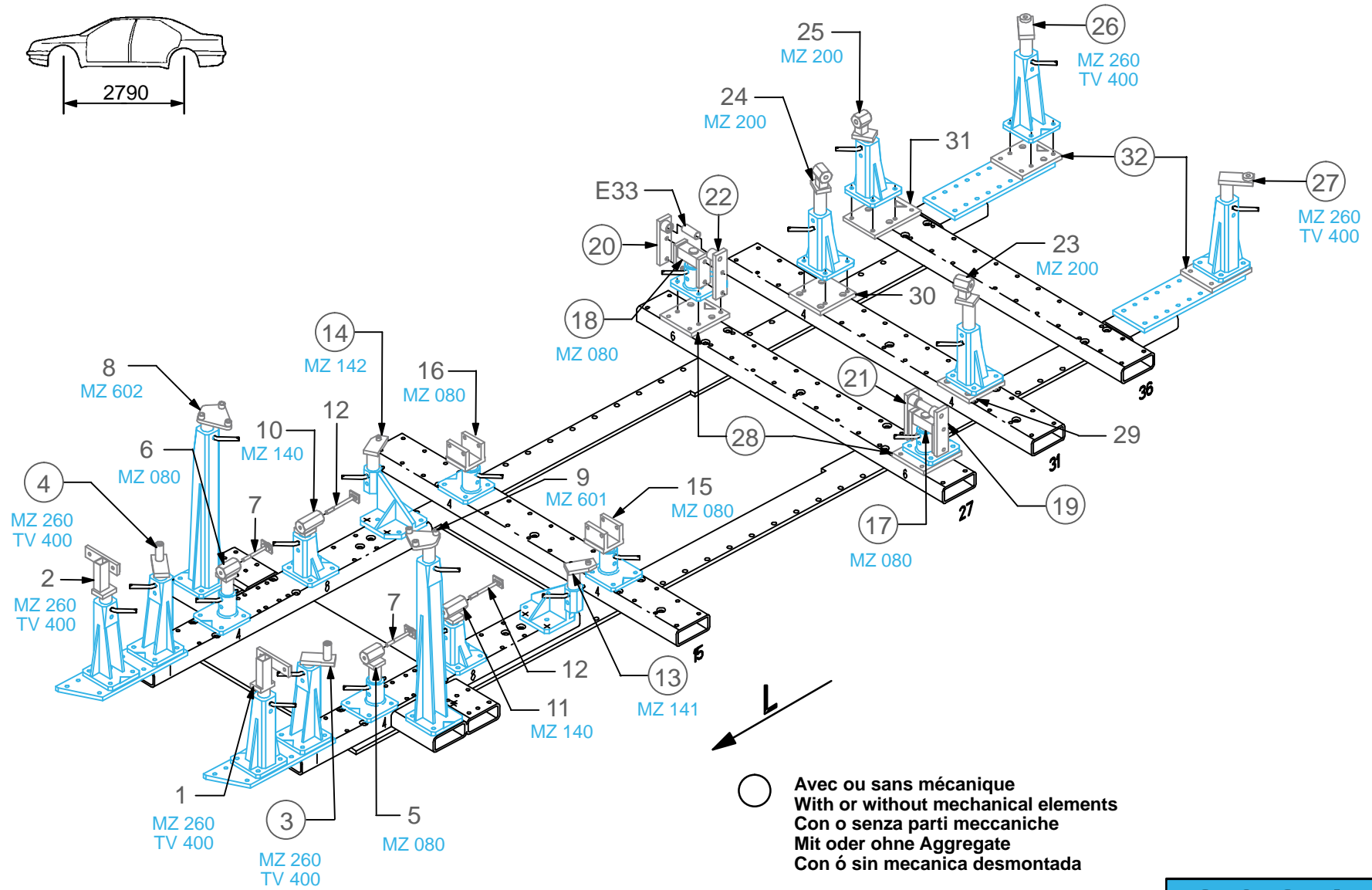
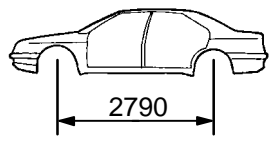

TOYOTA / LEXUS

2024.300

76 Kg 22.08.2005 434-D-79C

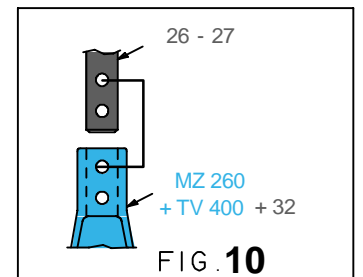
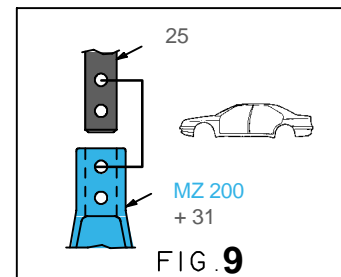
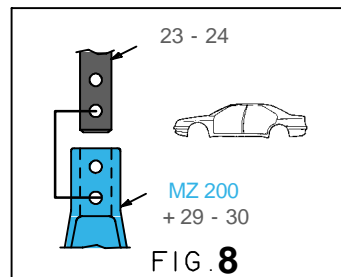
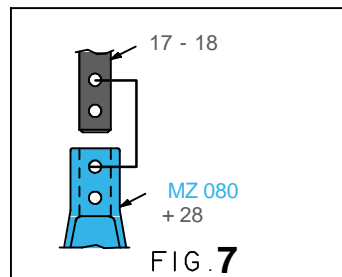
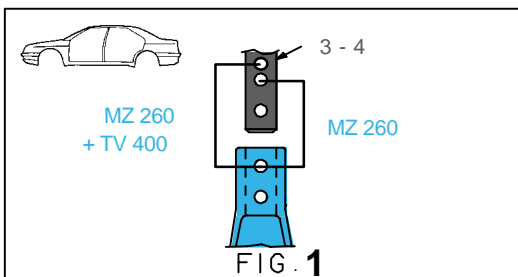
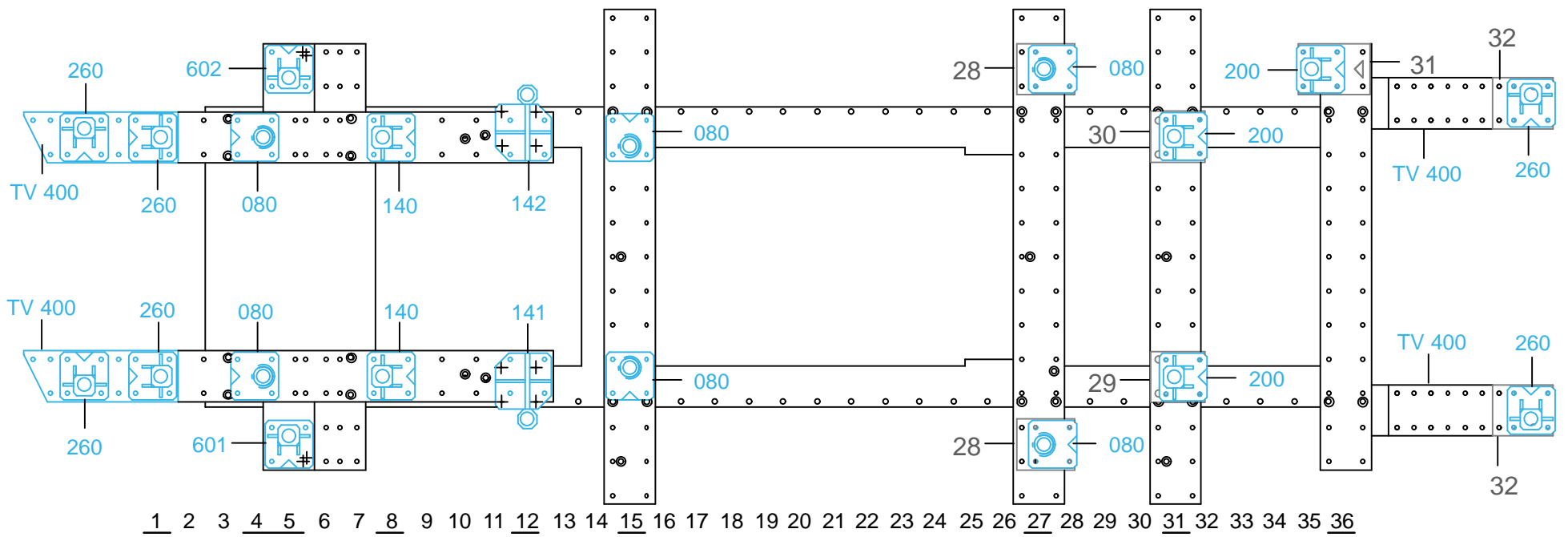

2024.300-RVA3-2 | 00

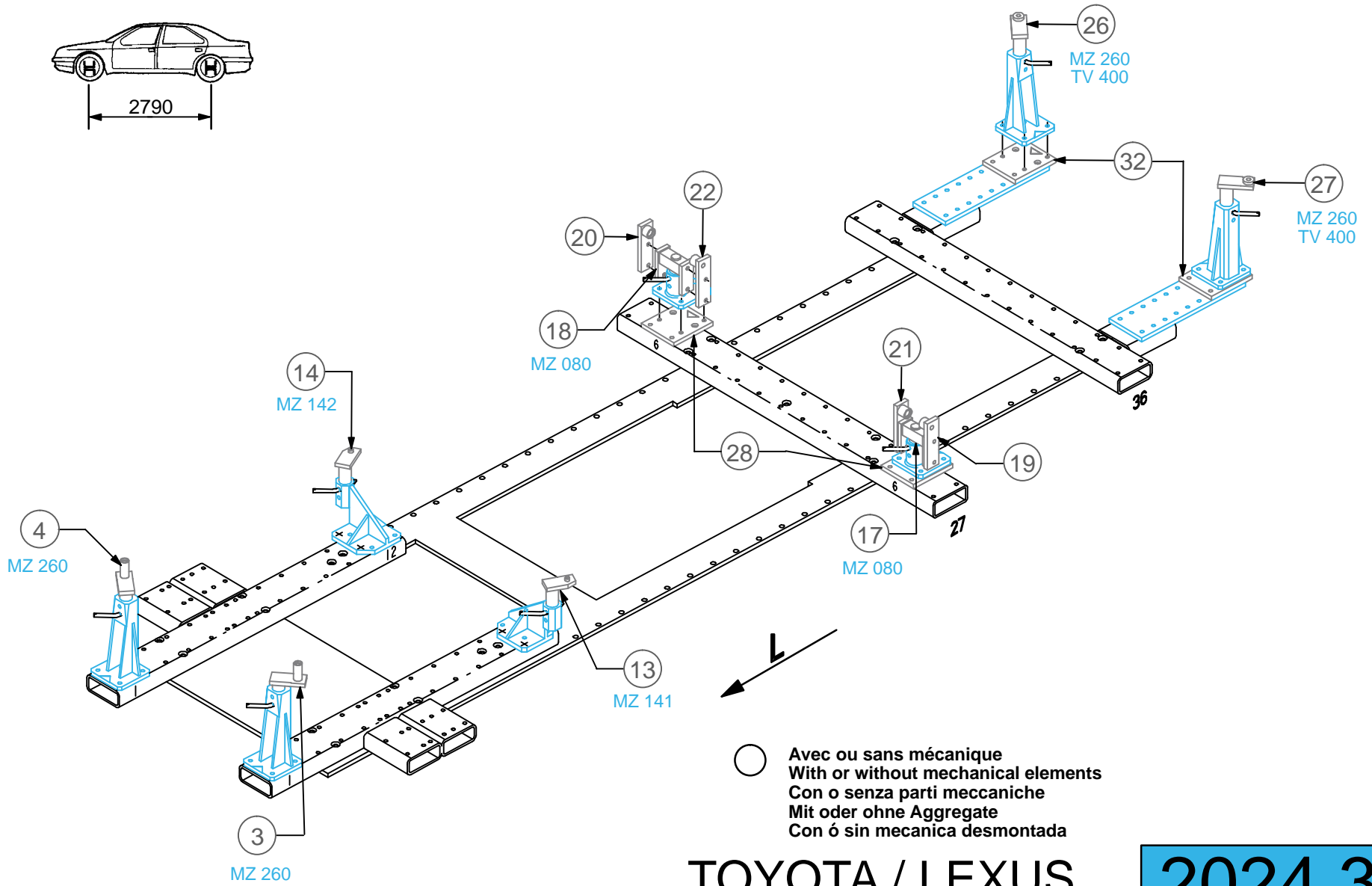

TOYOTA / LEXUS

2024.300

76 Kg	22.08.2005	434-D-79D
-------	------------	-----------

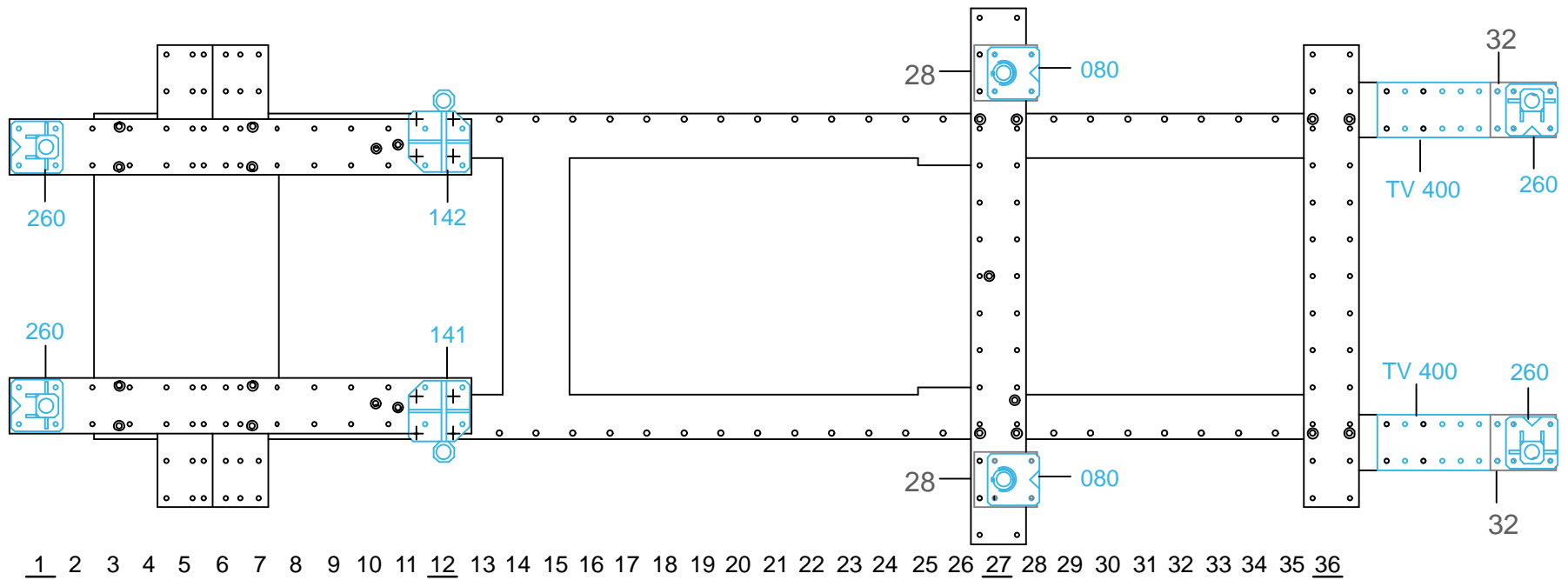

1 2 3 4 5 6 7 8 9 10 11 12 13 14 15 16 17 18 19 20 21 22 23 24 25 26 27 28 29 30 31 32 33 34 35 36

