

M8S
MT10
SVN

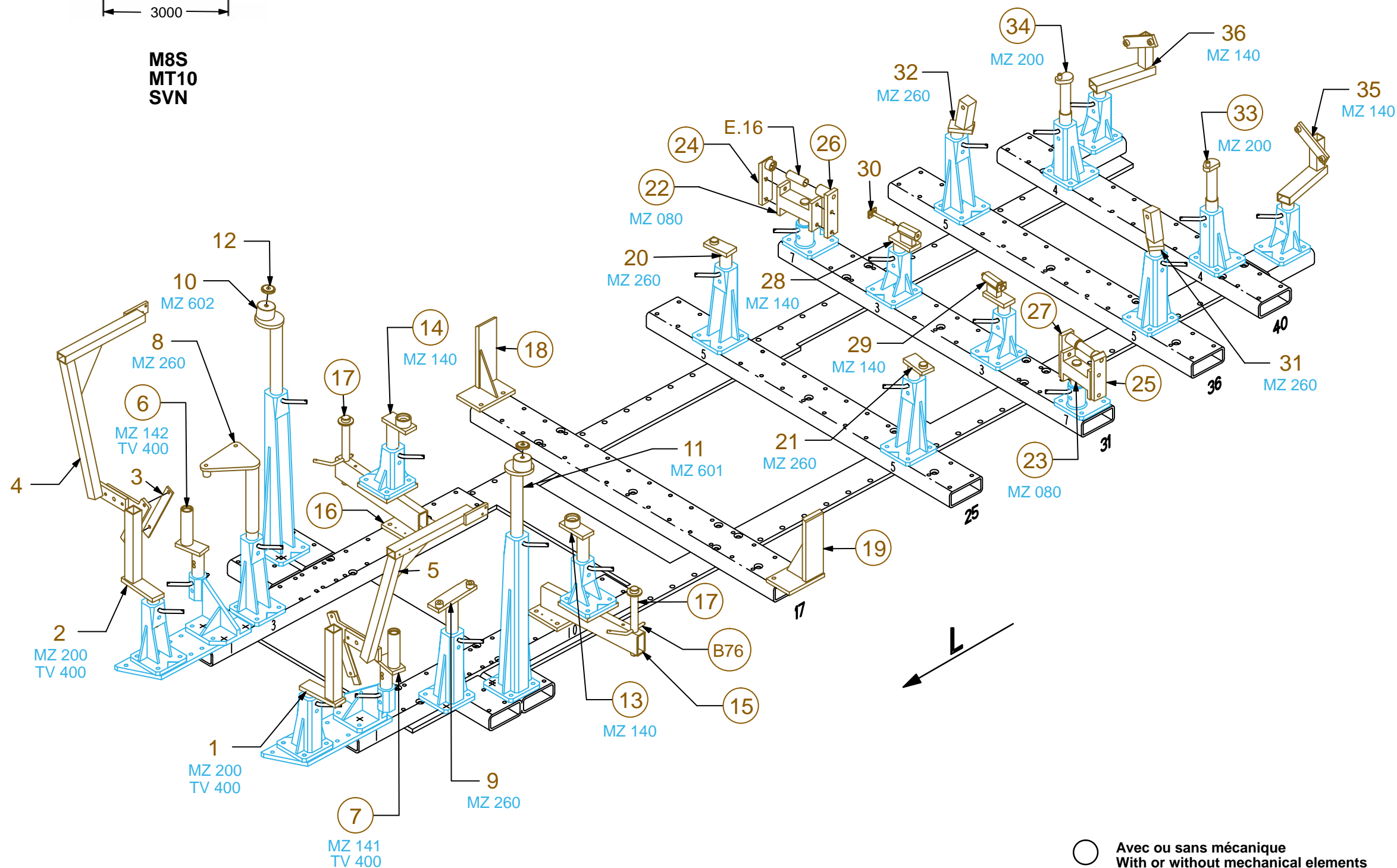

○ Avec ou sans mécanique
With or without mechanical elements
Con o senza parti meccaniche
Mit oder ohne Aggregate
Con ó sin mecanica desmontada

REP.	REFERENCE	PDS	NB	MZ
1	2012.7001	4,7	1	200
2	2012.7002	4,7	1	200
3	2012.7003	0,4	2	
4	2012.7004	4,3	1	
5	2012.7005	4,3	1	
6	2012.7006	3,2	1	142
7	2012.7007	3,2	1	141
8	2012.7008	3,4	1	260
9	2012.7009	3,2	1	260
10	2012.7010	3,0	1	602
11	2012.7011	3,0	1	601
12	2012.7012	0,1	2	
13	2012.7013	2,3	1	140/080
14	2012.7014	2,3	1	140/080
15	2012.7015	7,8	1	
16	2012.7016	7,8	1	
17	2012.7017	1,1	2	
18	2012.7018	4,6	1	
19	2012.7019	4,6	1	
20	2012.7020	1,8	1	260
21	2012.7021	1,8	1	260
22	2012.7022	3,0	1	080
23	2012.7023	3,0	1	080
24	2012.7024	1,0	1	
25	2012.7025	1,0	1	
26	2012.7026	1,2	1	
27	2012.7027	1,2	1	
28	2012.7028	2,2	1	140
29	2012.7029	2,2	1	140
30	2012.7030	0,1	2	
31	2012.7031	2,7	1	260
32	2012.7032	2,7	1	260
33	2012.7033	1,6	1	200
34	2012.7034	1,6	1	200
35	2012.7035	2,6	1	140
36	2012.7036	2,6	1	140
	B76	0,1	2	
	E.16	0,1	2	

	M 6-20	4
	M 8-25	4
	M 8-35	4
	M 10-45	2
	M 10-55	2
	M 12-20	2
	M 12-25	10
	M 12-30	8
	M 14x1,50-70	2
	M 14x1,50-140	2
M 14x1,50-180	2	
	M 10	2
	LU 10	2

2012.300

104 Kg	31.03.2003	438-D-27A
2012.300-RVA3-1		00

VAS 6236

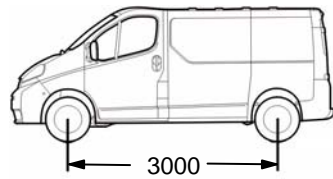

M8S
MT10
SVN

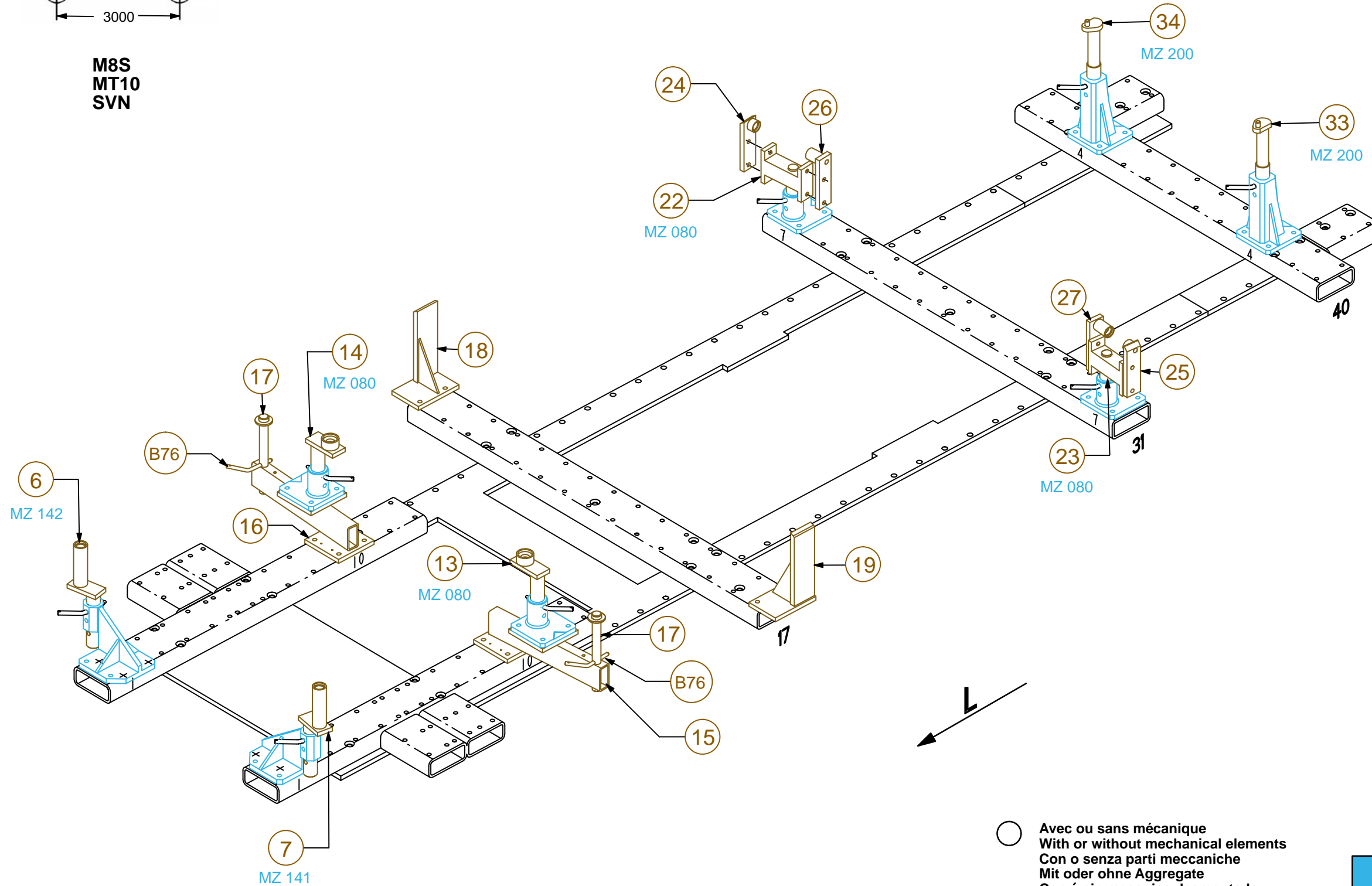

○ Avec ou sans mécanique
With or without mechanical elements
Con o senza parti meccaniche
Mit oder ohne Aggregate
Con ó sin mecanica desmontada

VAS 6236

2012.300		
104 Kg	31.03.2003	438-D-27B
2012.300-RVA3-1		00

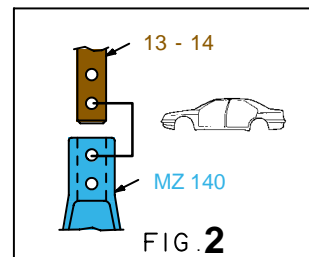
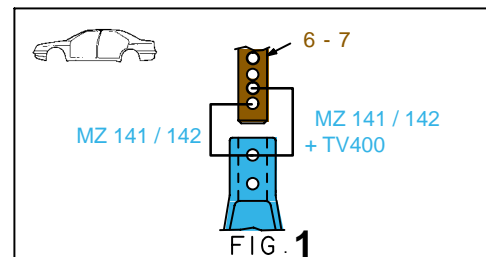
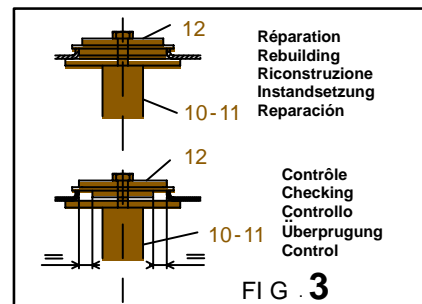
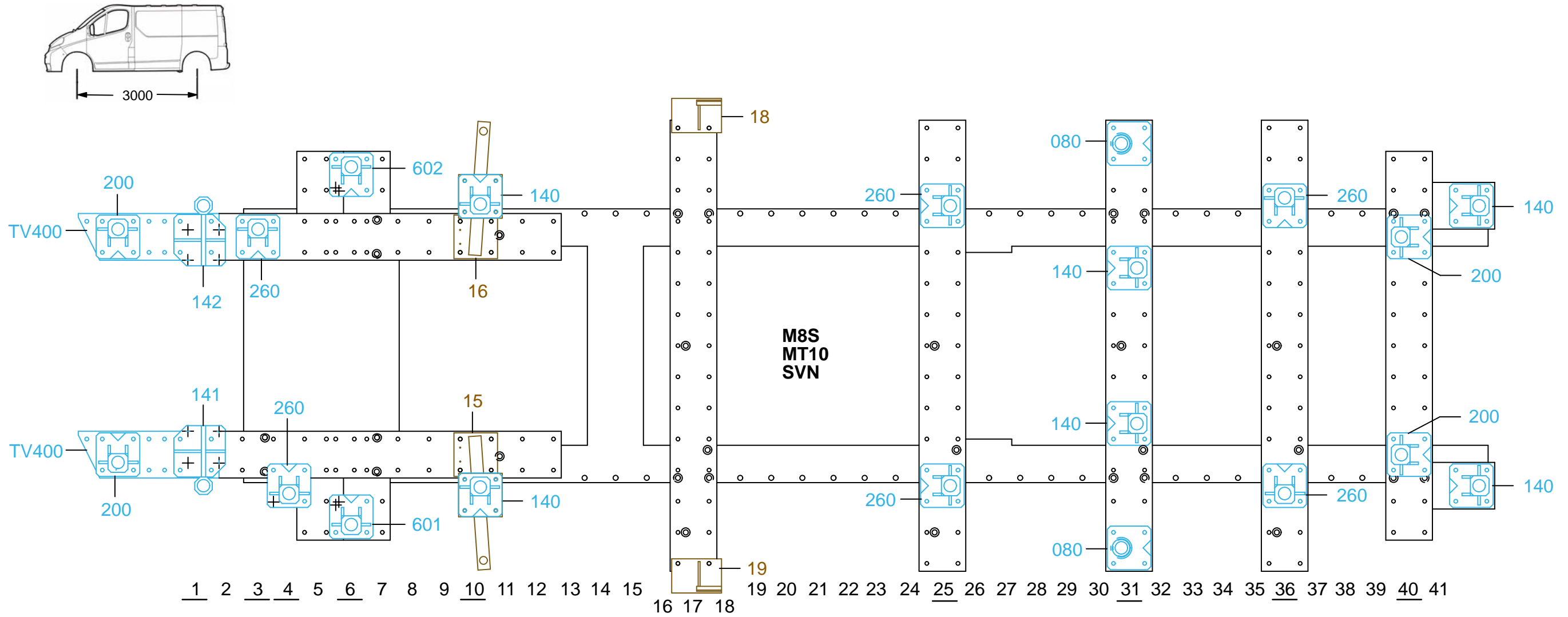

○ Avec ou sans mécanique
With or without mechanical elements
Con o senza parti meccaniche
Mit oder ohne Aggregate
Con ó sin mecanica desmontada

VAS 6236

2012.300

104 Kg | 31.03.2003 | 438-D-27C

2012.300-RVA3-2 | 00

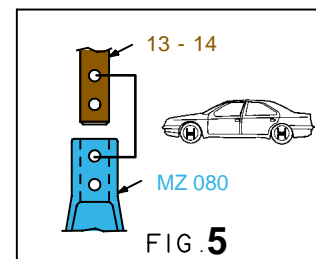
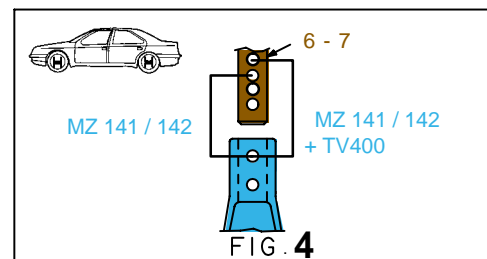
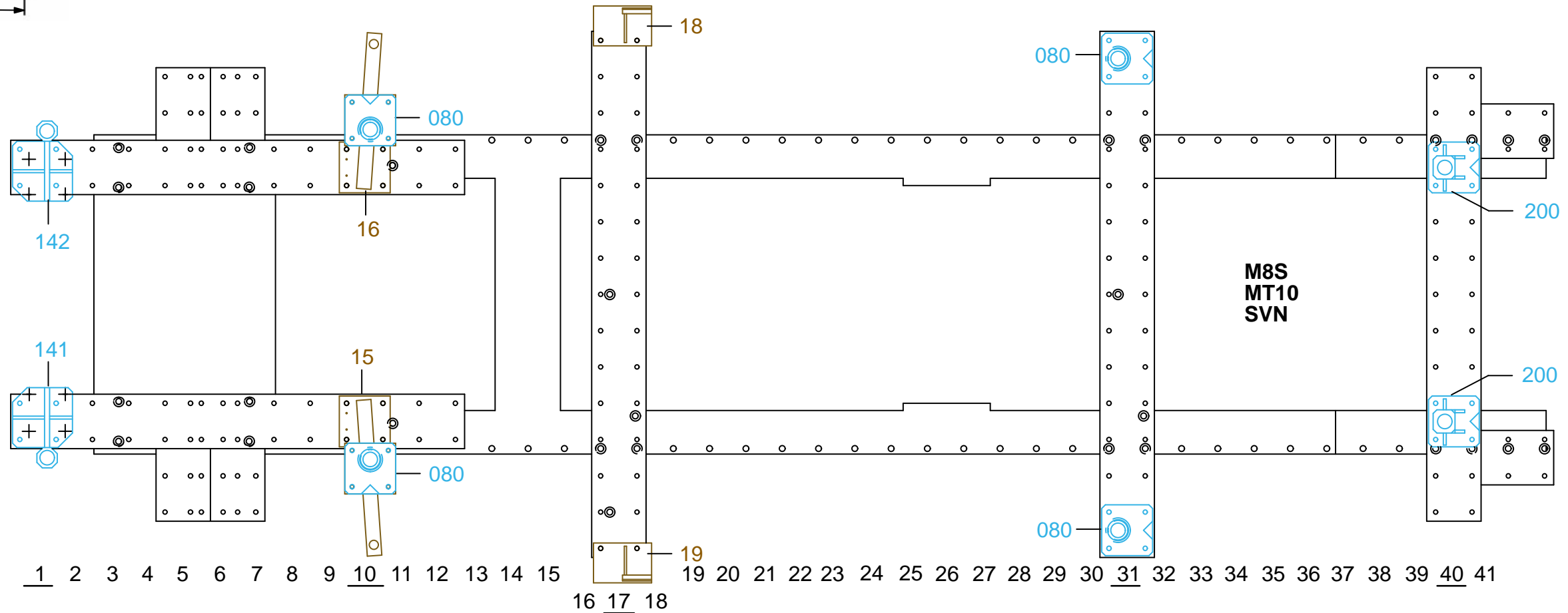
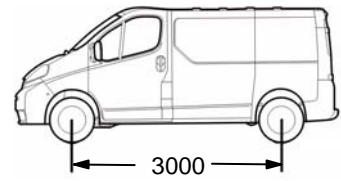

○ Avec ou sans mécanique
 With or without mechanical elements
 Con o senza parti meccaniche
 Mit oder ohne Aggregate
 Con ó sin mecanica desmontada

VAS 6236



2012.300

104 Kg	31.03.2003	438-D-27D
2012.300-RVA3-2		00

Choc avant
Front crash
Frontreparatur
Urto anteriore
Choque delantero

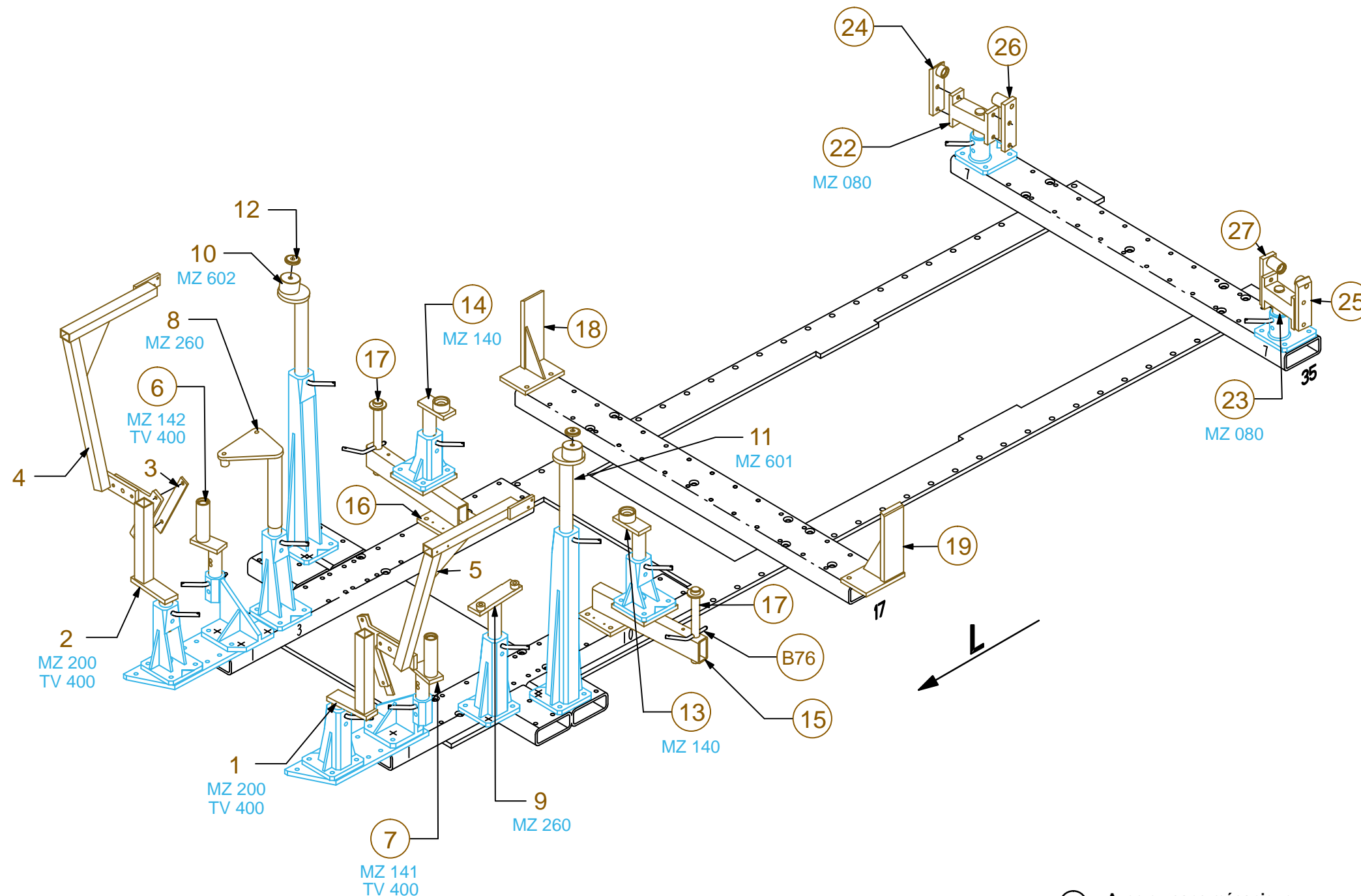
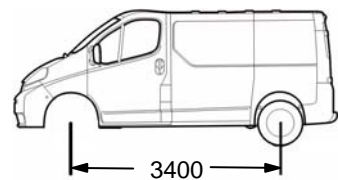

○ Avec ou sans mécanique
With or without mechanical elements
Con o senza parti meccaniche
Mit oder ohne Aggregate
Con ó sin mecanica desmontada

VAS 6236

2012.300

104 Kg	31.03.2003	438-D-27E
2012.300-RVA3-3		00

Choc arrière
Rear crash
Heckreparatur
Urto posteriore
Choque trasero

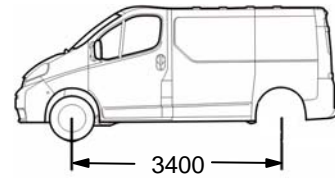

M8S
MT10
SVN

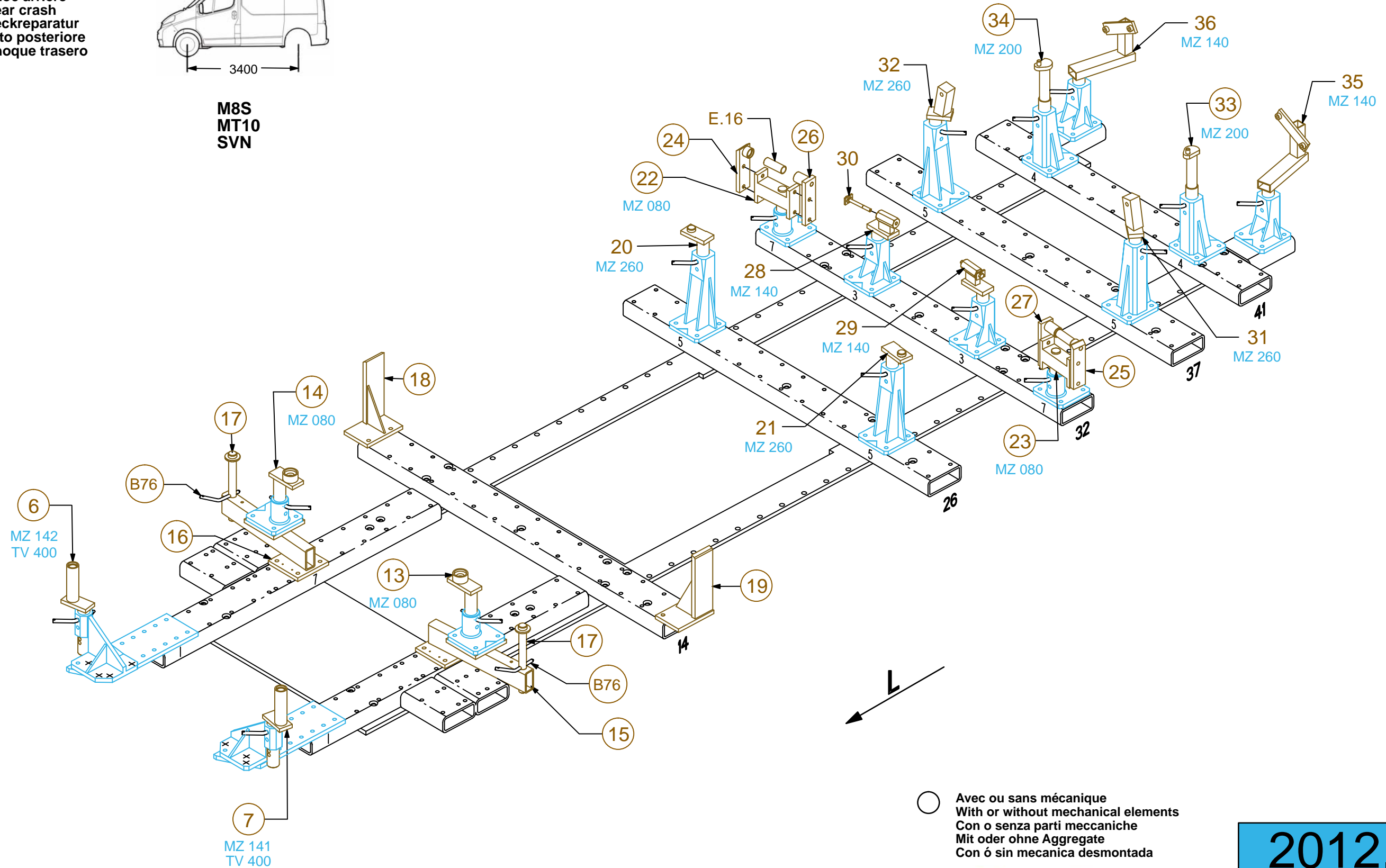

VAS 6236

2012.300		
104 Kg	31.03.2003	438-D-27F
2012.300-RVA3-3		00

Choc avant
Front crash
Frontreparatur
Urto anteriore
Choque delantero

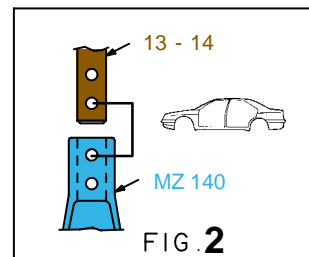
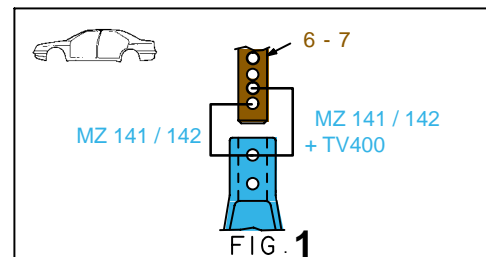
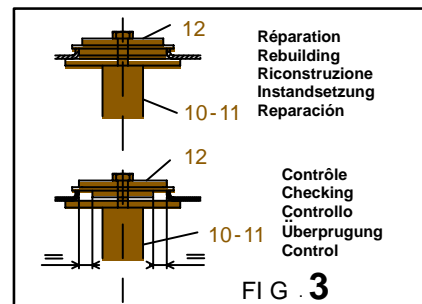
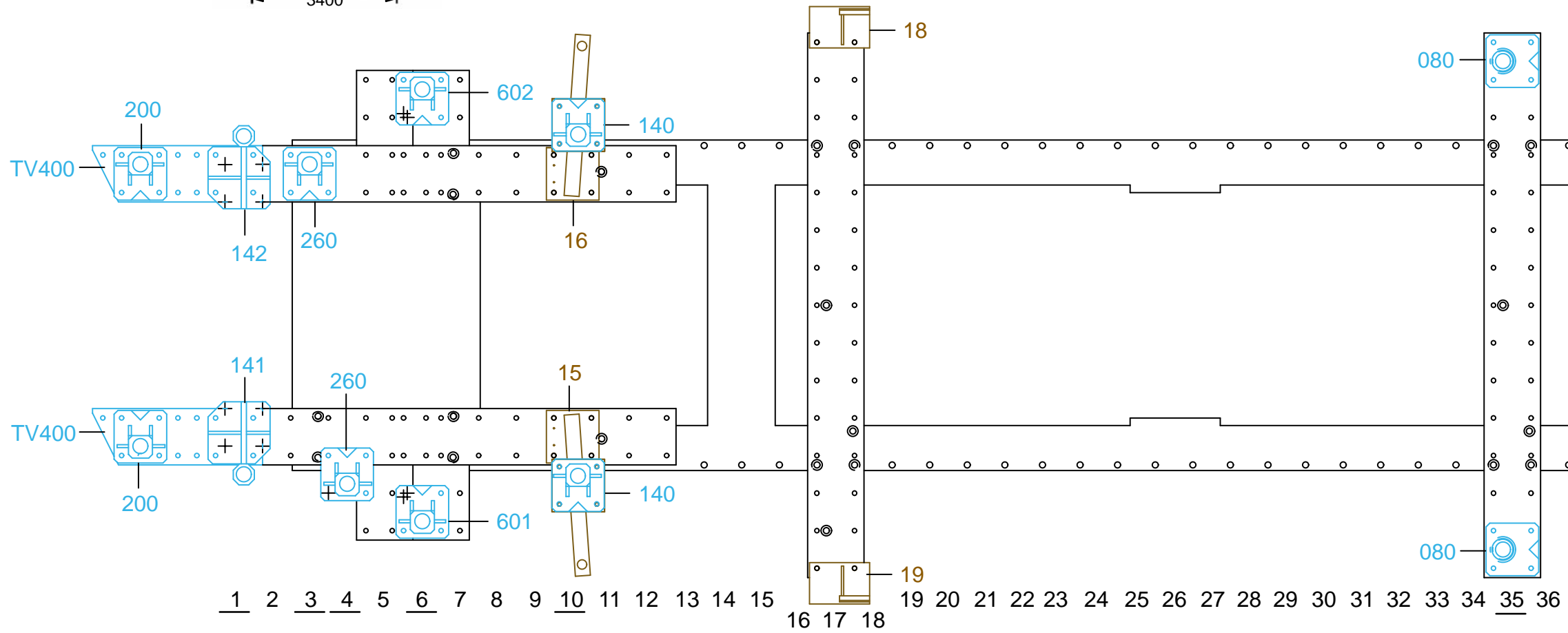
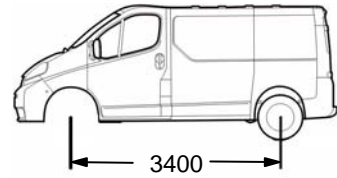

○ Avec ou sans mécanique
With or without mechanical elements
Con o senza parti meccaniche
Mit oder ohne Aggregate
Con ó sin mecanica desmontada

VAS 6236



2012.300

104 Kg | 31.03.2003 | 438-D-27G

2012.300-RVA3-4 | 00

Choc arrière
Rear crash
Heckreparatur
Urto posteriore
Choque trasero

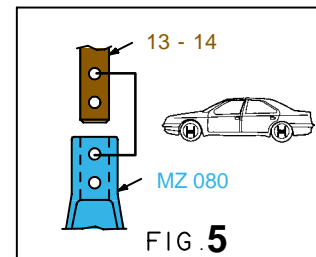
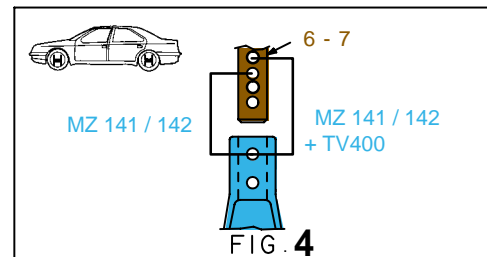
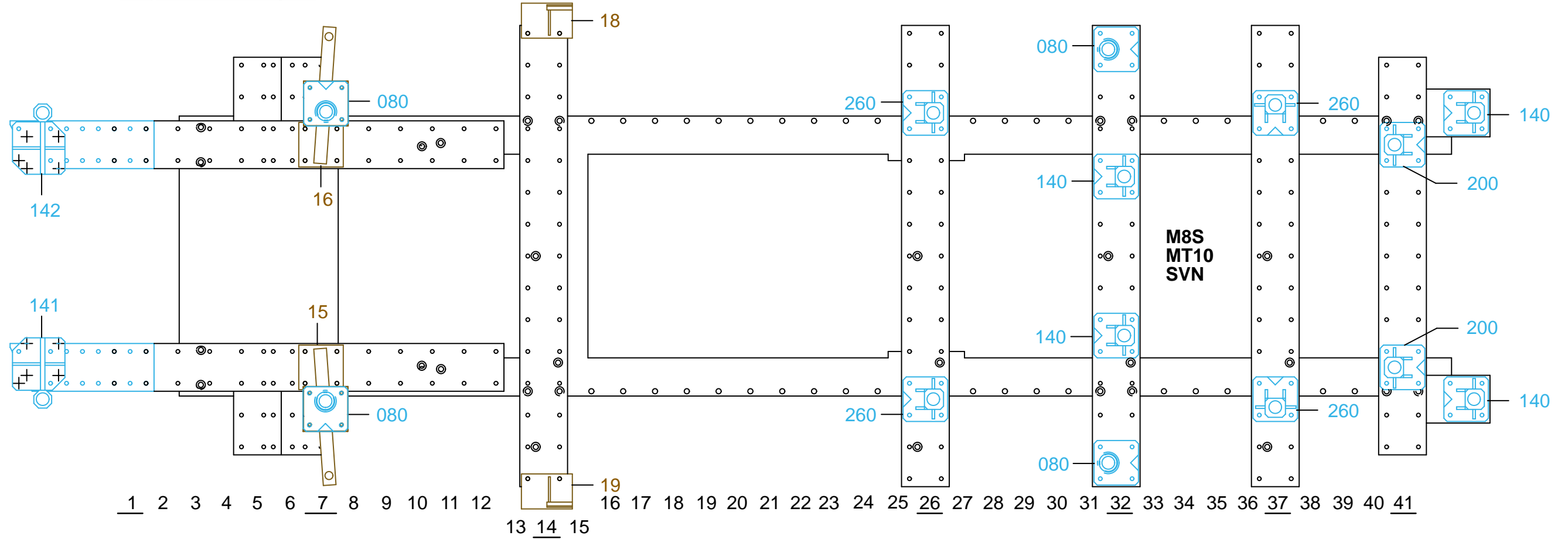
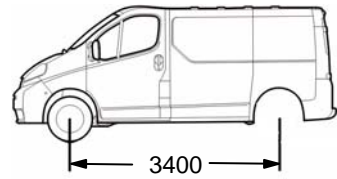

○ Avec ou sans mécanique
With or without mechanical elements
Con o senza parti meccaniche
Mit oder ohne Aggregate
Con ó sin mecánica desmontada

2012.300

104 Kg	31.03.2003	438-D-27H
2012.300-RVA3-4		00

VAS 6236