

5 Portes
5 - Türlig
5 Door

VAS 5007/19A



| REP. | REFERENCE | PDS | NB |
|------|-----------|-----|----|
| 7 | 2010.7507 | 3,9 | 1 |
| 8 | 2010.7508 | 3,9 | 1 |
| 9 | 2010.7509 | 2,8 | 1 |
| 10 | 2010.7510 | 2,8 | 1 |
| 19 | 2010.7519 | 4,0 | 1 |
| 20 | 2010.7520 | 4,0 | 1 |
| 21 | 2010.7521 | 2,7 | 1 |
| 22 | 2010.7522 | 2,7 | 1 |

| | |
|---------|---|
| M 8-25 | 8 |
| M 12-30 | 2 |
| M 8 | 2 |
| M 12 | 2 |

complément au
complementary set to
complemento al
zusatz zu

**2010.300 +
2010.309 +
9113.053**

2010.830

| | | |
|-------|------------|-----------------|
| 27 Kg | 01.09.2004 | 2010.830-RVA3-1 |
|-------|------------|-----------------|

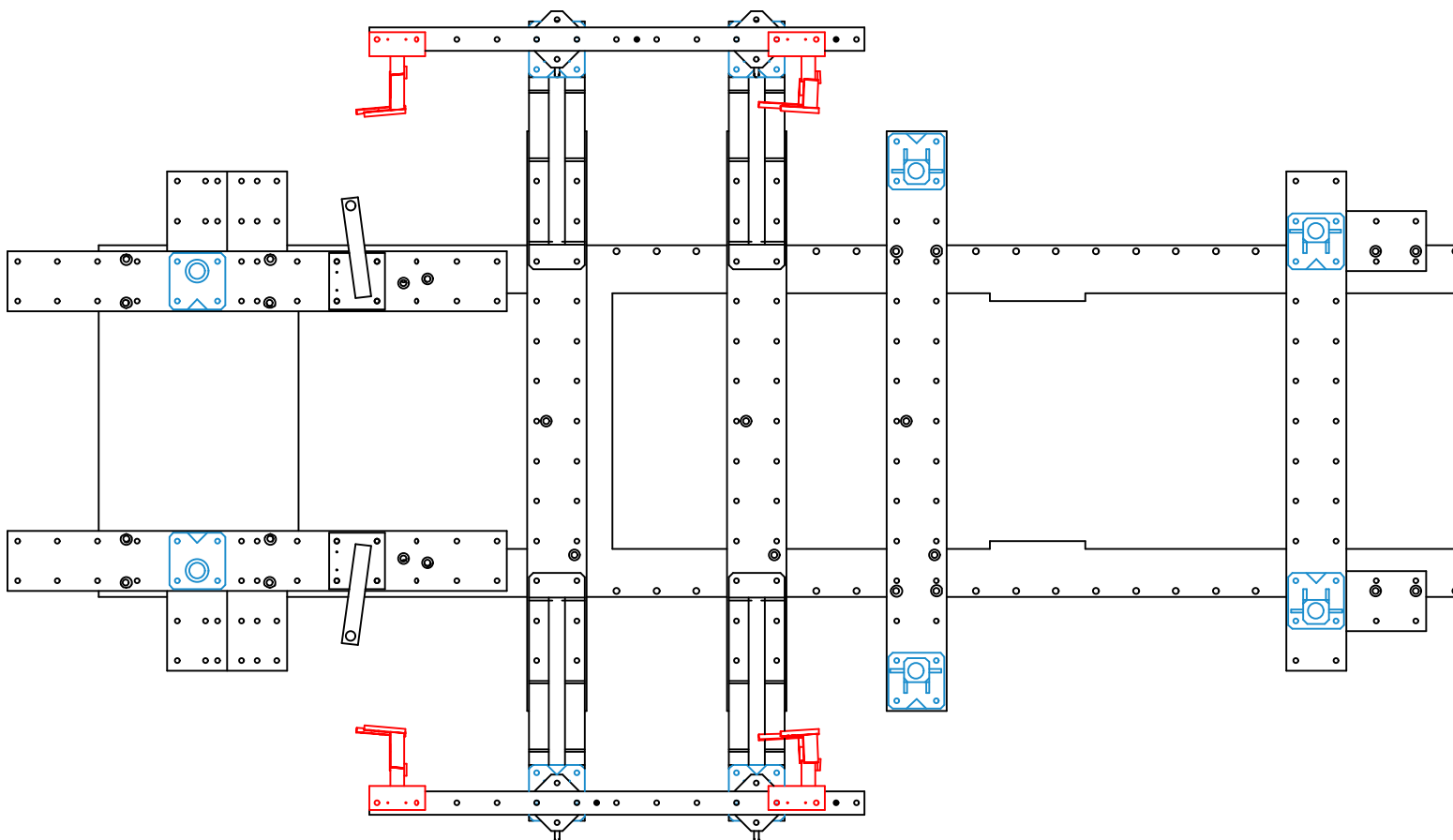

1 2 3 4 5 6 7 8 9 10 11 12 13 14 15 16 17 18 19 20 21 22 23 24 25 26 27 28 29 30 31 32 33 34 35 36

2010.830-RVA3-1 00

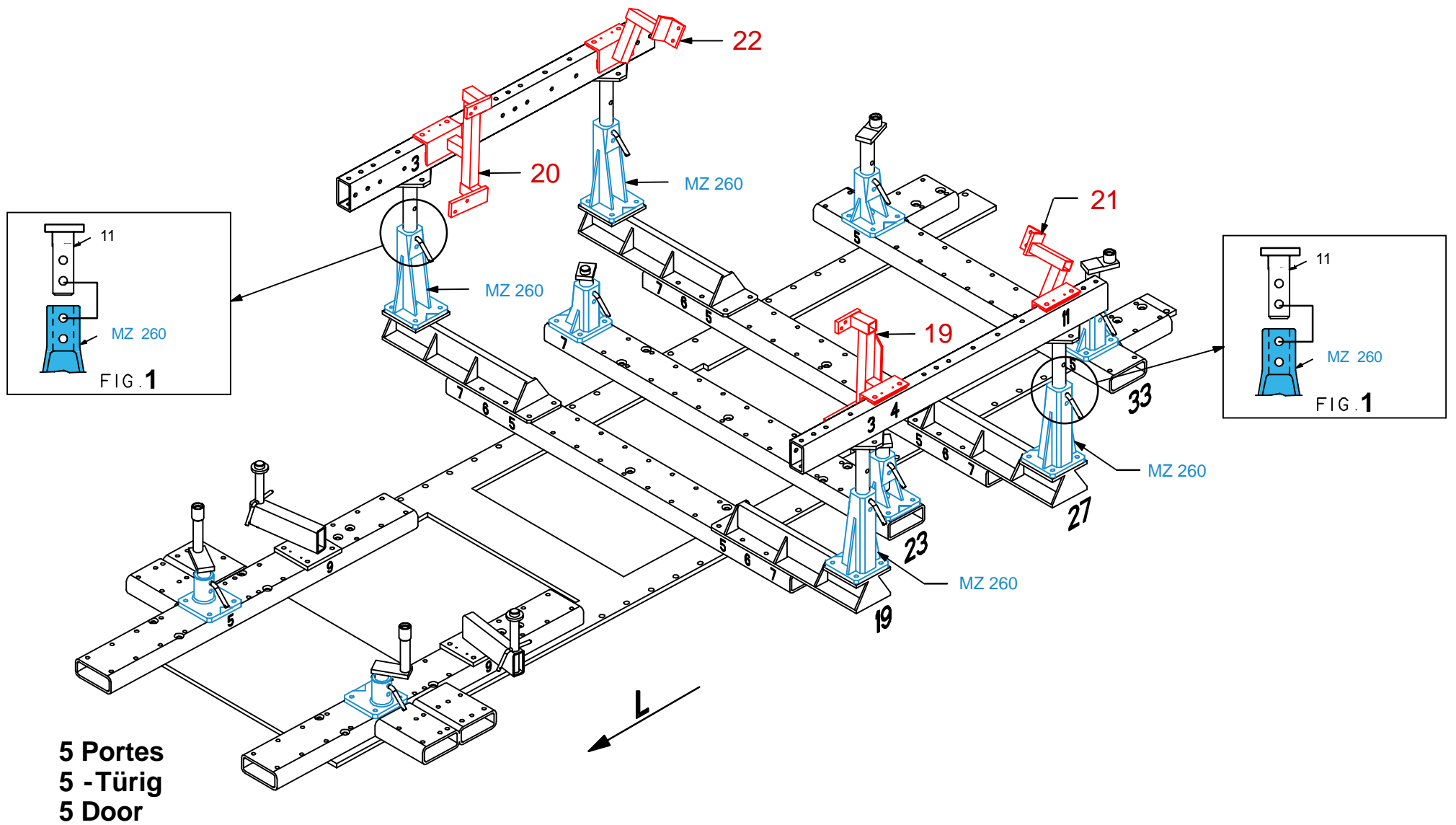

VAS 5007/19A



2010.830

27 Kg | 01.09.2004 | 2010.830-RVA3-1

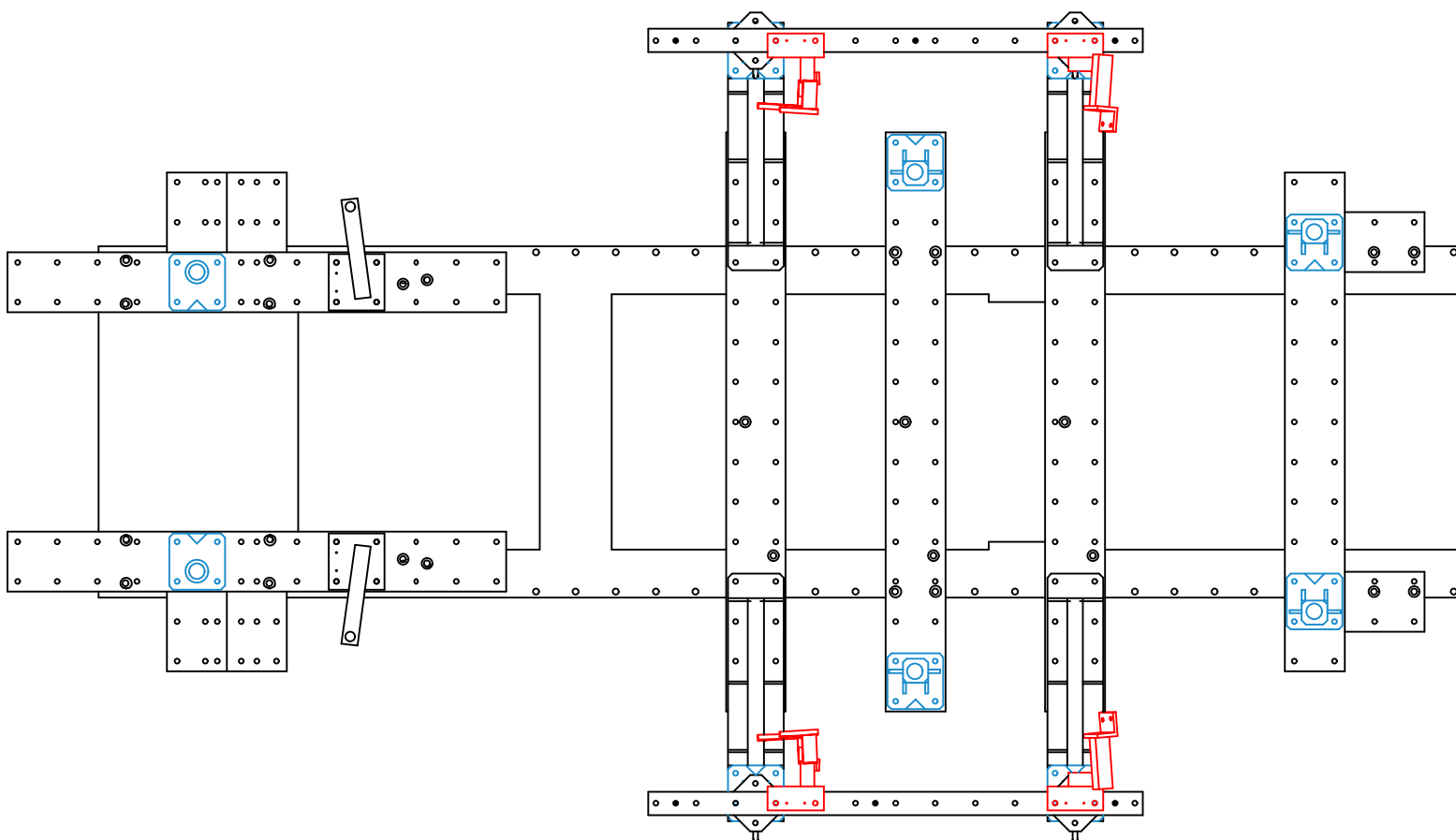

1 2 3 4 5 6 7 8 9 10 11 12 13 14 15 16 17 18 19 20 21 22 23 24 25 26 27 28 29 30 31 32 33 34 35 36

2010.830-RVA3-1 | 00

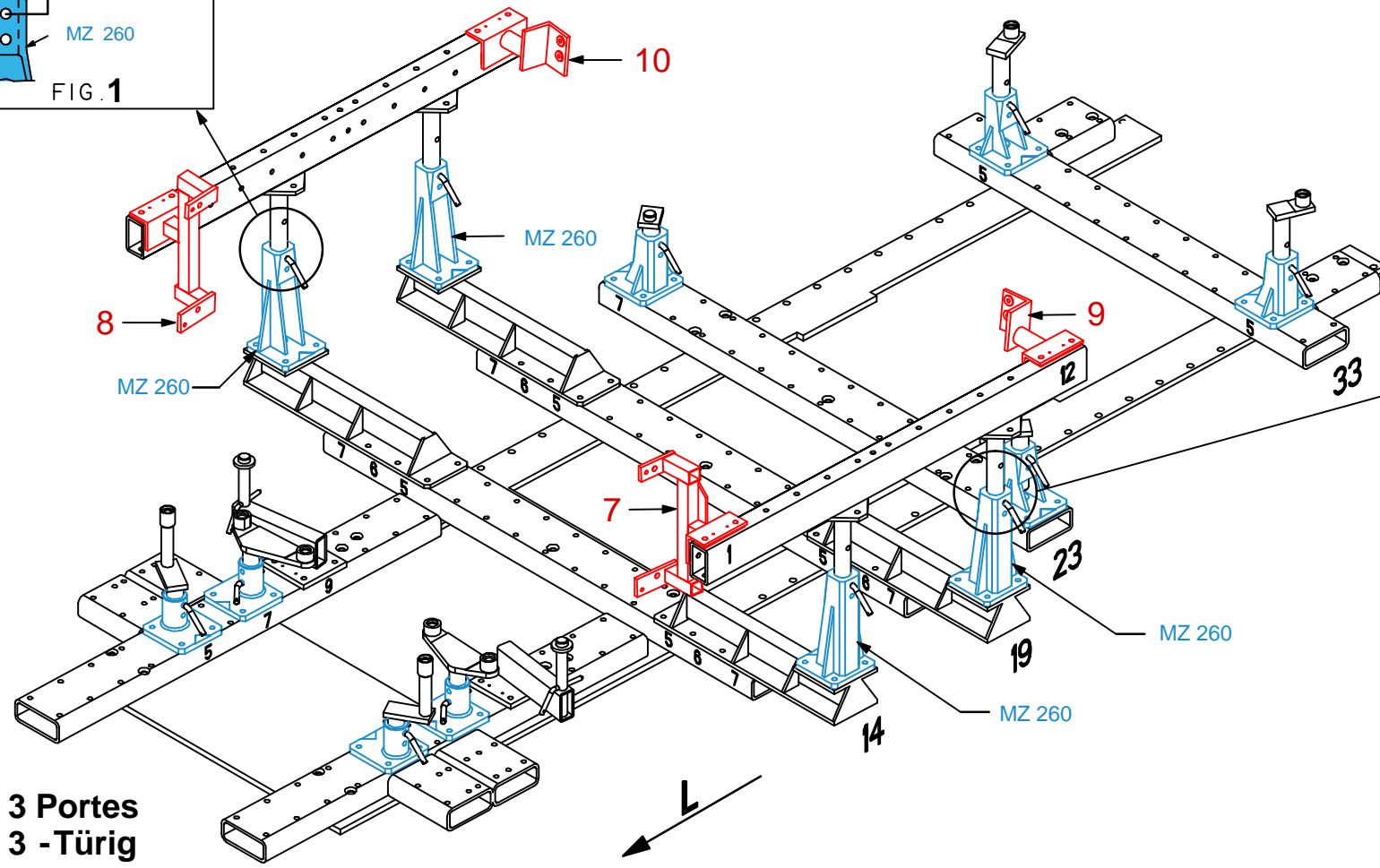
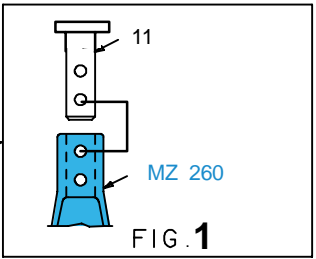
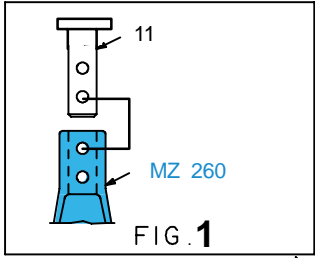

3 Portes
3 - Türlig
3 Door

VAS 5007/19A



2010.830

27 Kg | 01.09.2004 | 2010.830-RA3-2

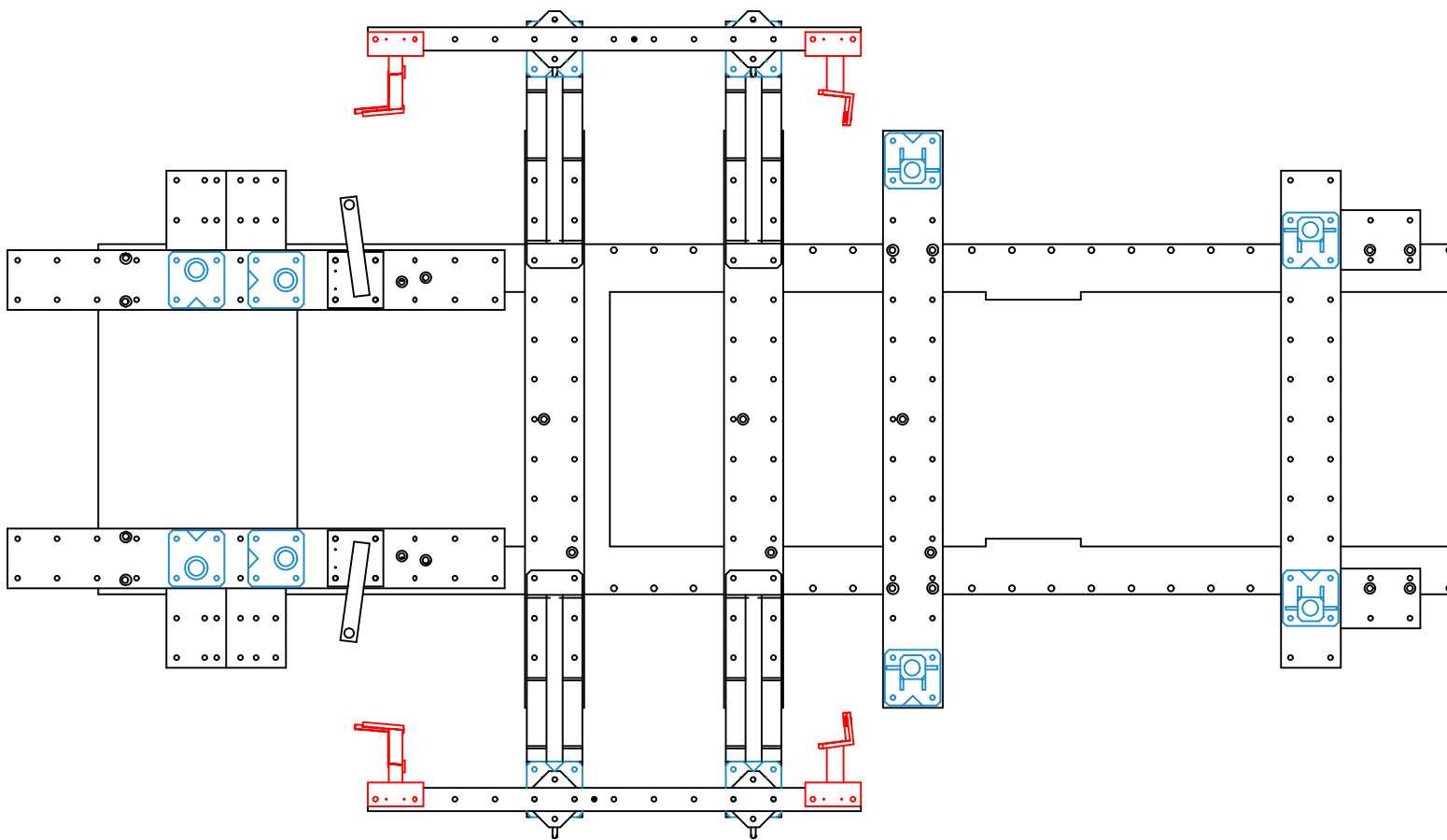

1 2 3 4 5 6 7 8 9 10 11 12 13 14 15 16 17 18 19 20 21 22 23 24 25 26 27 28 29 30 31 32 33 34 35 36

2010.830-RA3-2 | 00