

* = A3 QUATTRO

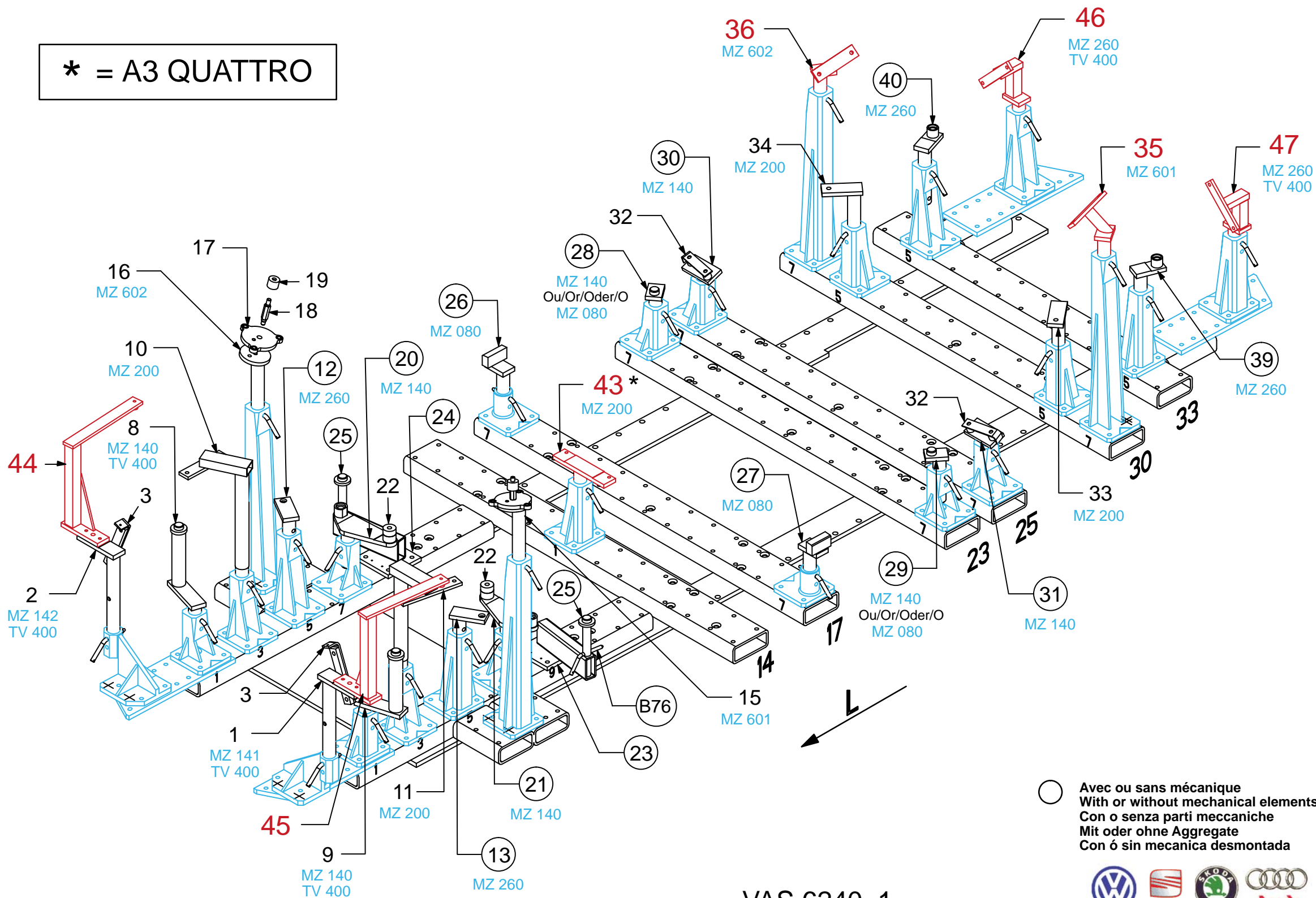

VAS 6240-1



REP.	REFERENCE	PDS	NB	MZ
35	2010.7035	2,2	1	601
36	2010.7036	2,2	1	602
43	2010.7043	2,3	1	200
44	2010.7044	3,0	1	
45	2010.7045	3,0	1	
46	2010.7046	2,6	1	260
47	2010.7047	2,6	1	260

M 8-25	6
M 10-20	4

complément au
complementary set to
complemento al
zusatz zu **2010.300**

2010.309

19 Kg	15.05.2003	403-D-17A
-------	------------	-----------

2010.309-RVA3-1 01

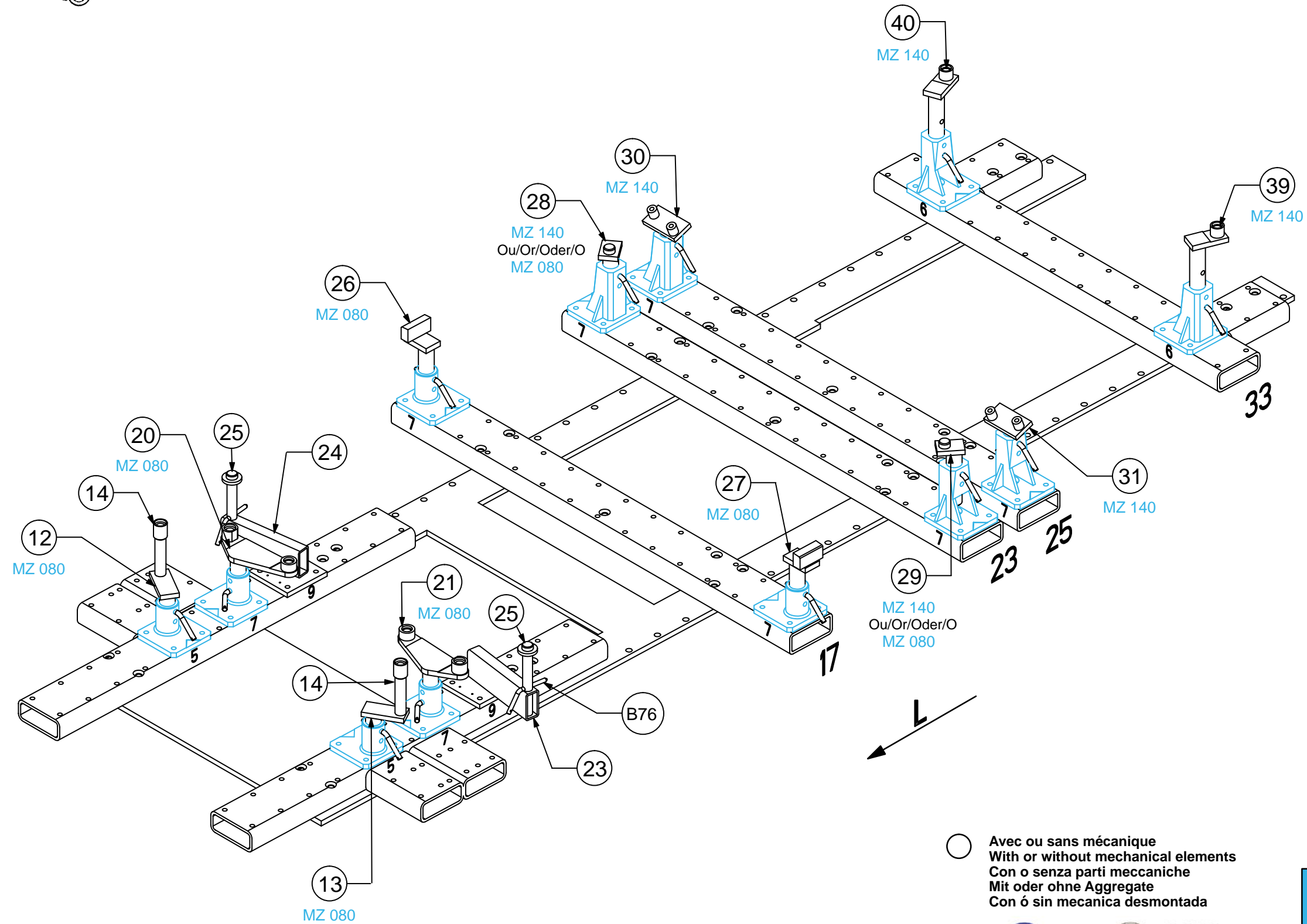

○ Avec ou sans mécanique
 With or without mechanical elements
 Con o senza parti meccaniche
 Mit oder ohne Aggregate
 Con ó sin mecanica desmontada

VAS 6240-1



2010.309

19 Kg	28.07.2003	403-D-17B
2010.309-RVA3-1		01



*** = A3 QUATTRO**

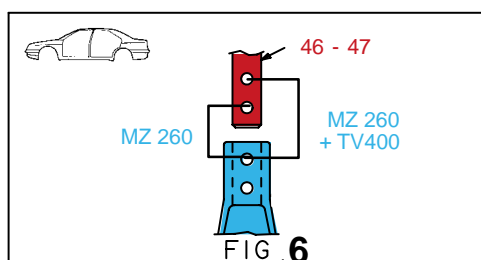
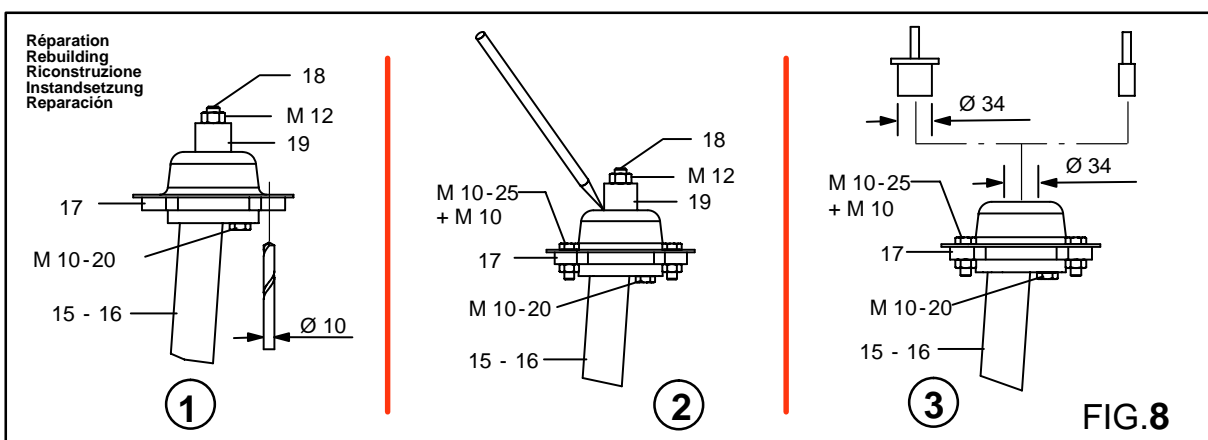
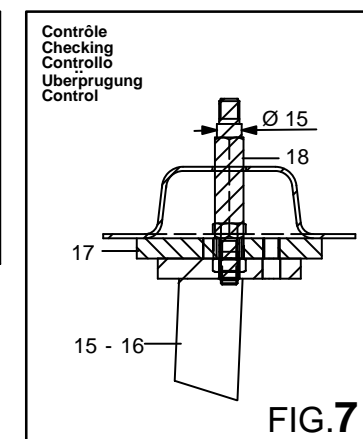
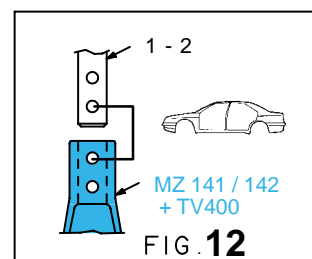
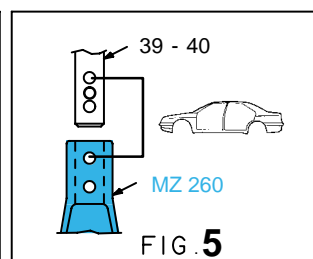
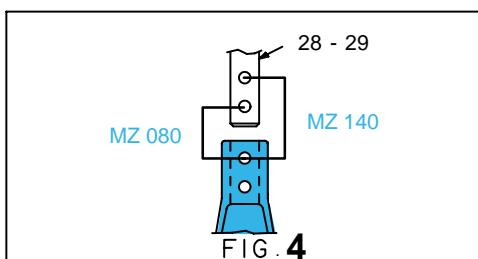
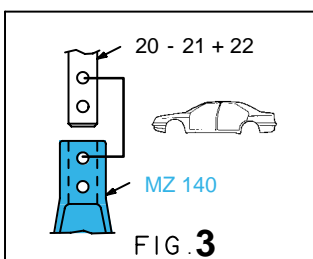
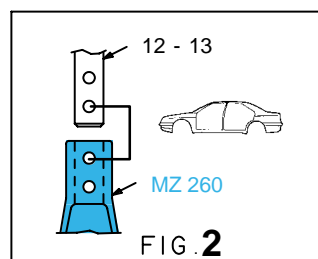
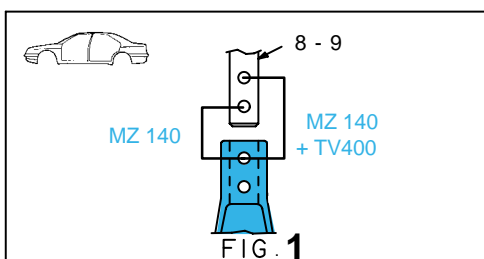
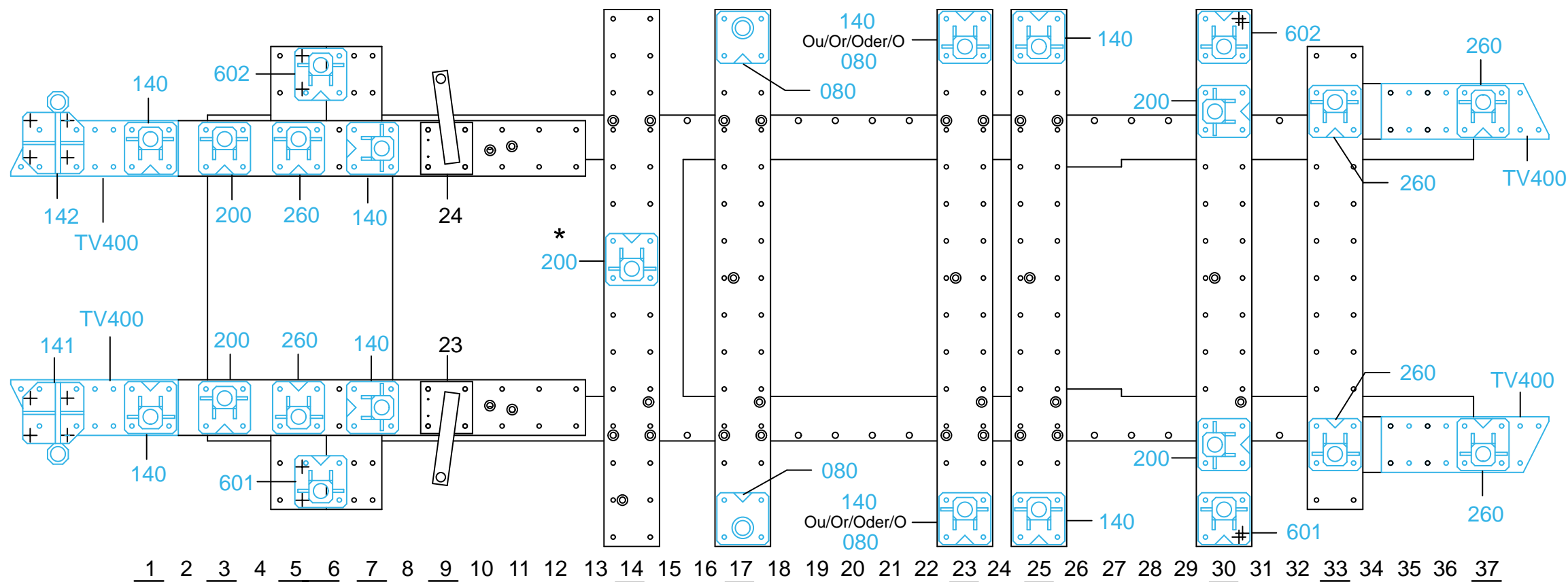

○ Avec ou sans mécanique
With or without mechanical elements
Con o senza parti meccaniche
Mit oder ohne Aggregate
Con ó sin mecanica desmontada

VAS 6240-1

2010.309

19 Kg | 15.05.2003 | 403-D-17C

2010.309-RVA3-2

01

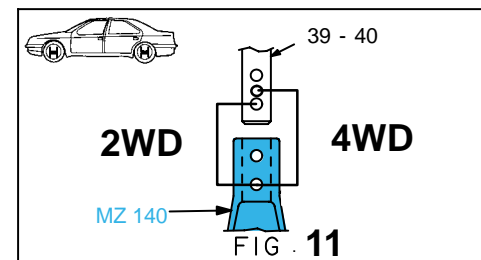
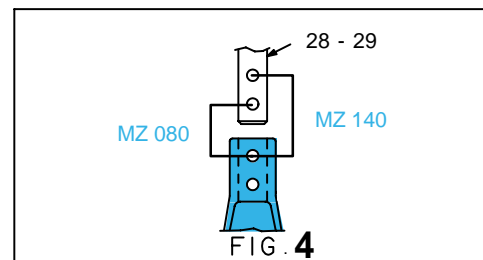
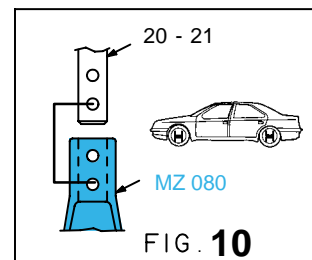
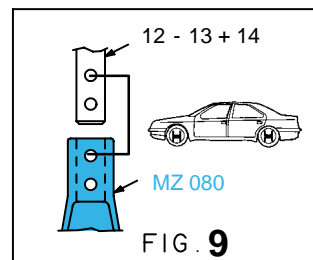
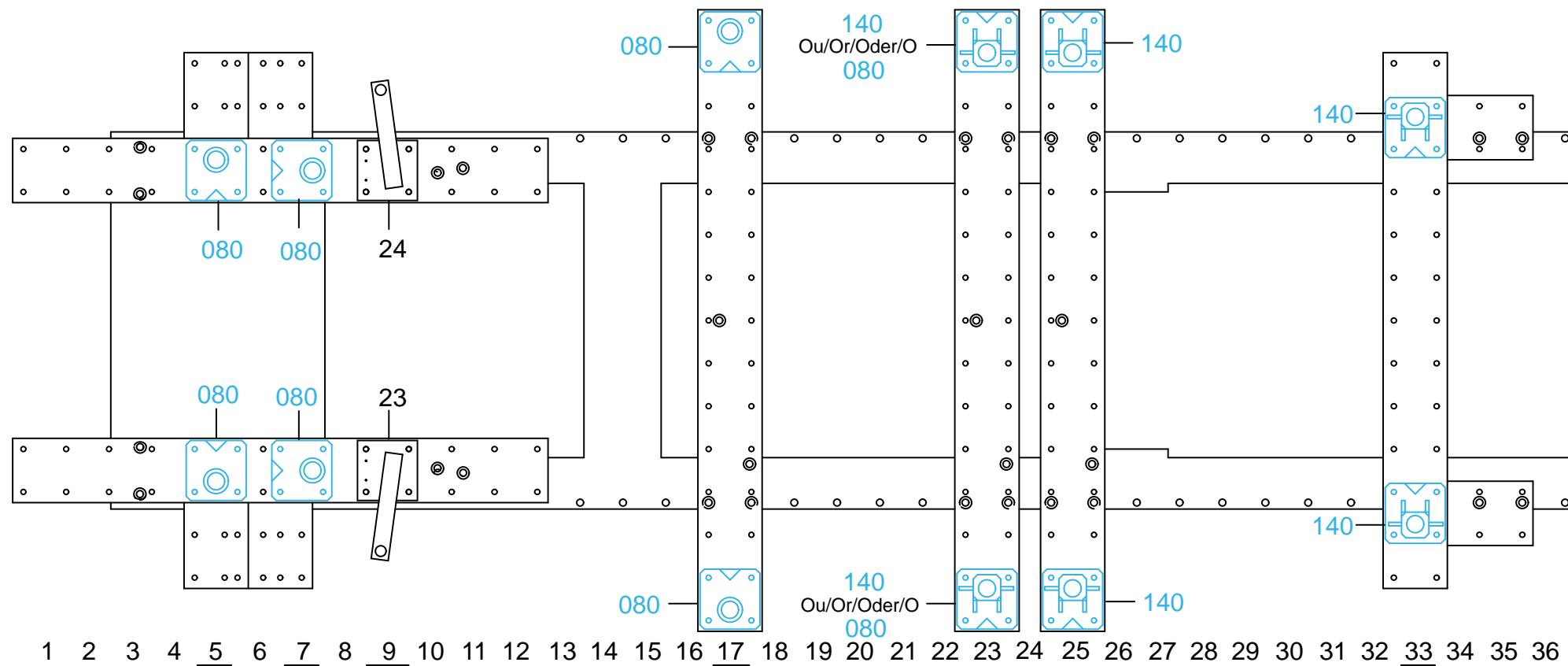
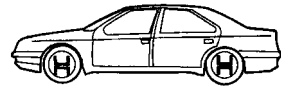

○ Avec ou sans mécanique
 With or without mechanical elements
 Con o senza parti meccaniche
 Mit oder ohne Aggregate
 Con ó sin mecanica desmontada

VAS 6240-1



2010.309

19 Kg	28.07.2003	403-D-17D
2010.300-RVA3-2		01