

**VAS 6240-6**



REP.	REFERENCE	PDS	NB	MZ
73	2010.7073	2,6	1	
74	2010.7074	2,6	1	
75	2010.7075	1,9	1	601
76	2010.7076	1,9	1	602
77	2010.7077	3,1	1	142
78	2010.7078	3,1	1	141
79	2010.7079	4,8	1	200
80	2010.7080	0,3	2	

M 6-35	2
M 8-25	4
M 8-30	2
M 10-20	4

complément au  
complementary set to  
complemento al  
zusatz zu **2010.300**

**2010.306**

21 Kg	05.12.2005	438-D-32A
-------	------------	-----------



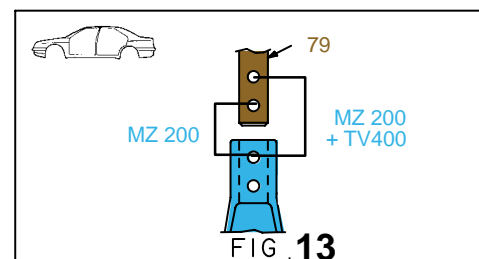
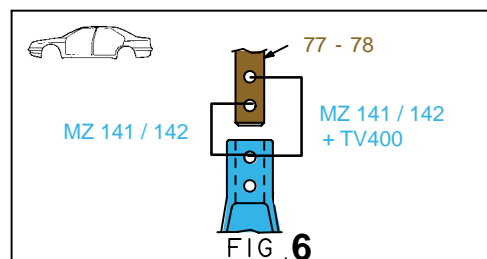
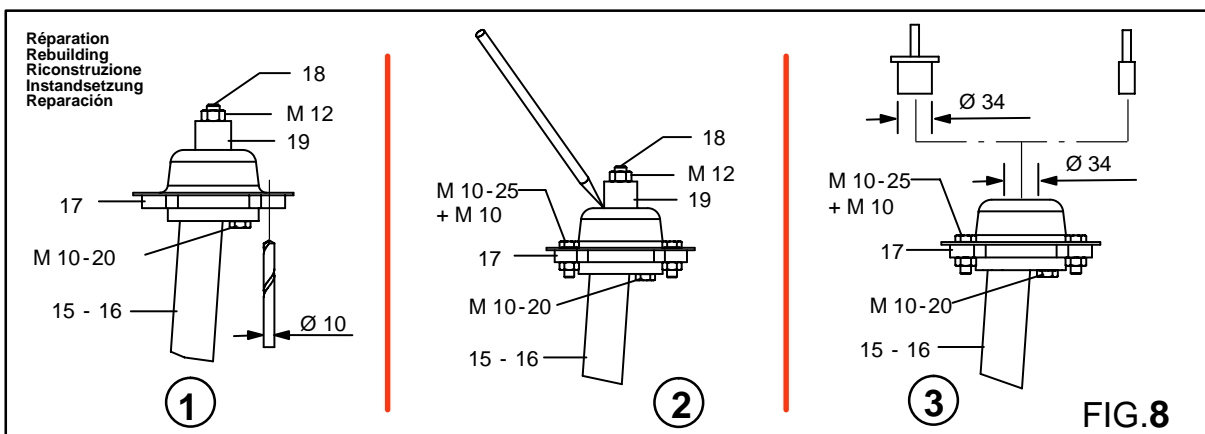
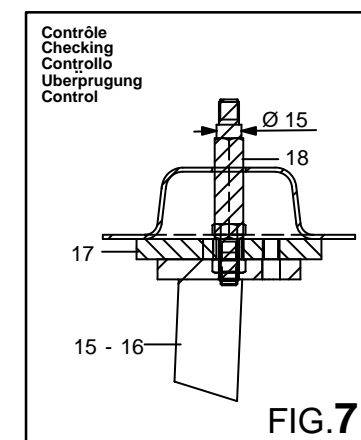
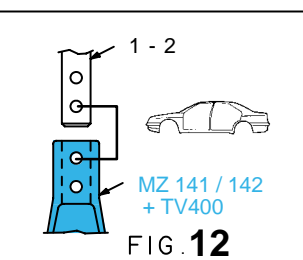
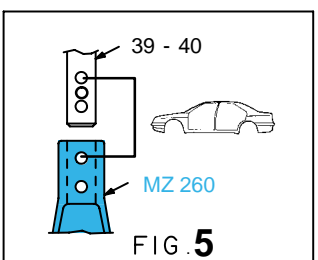
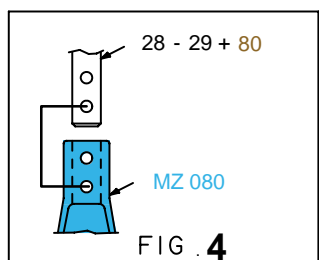
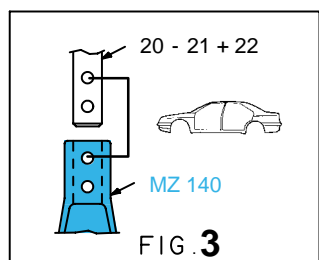
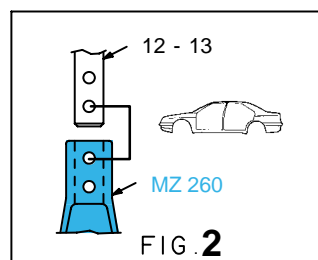
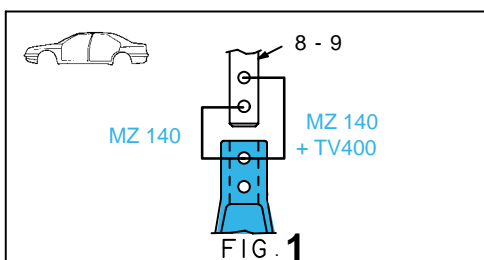
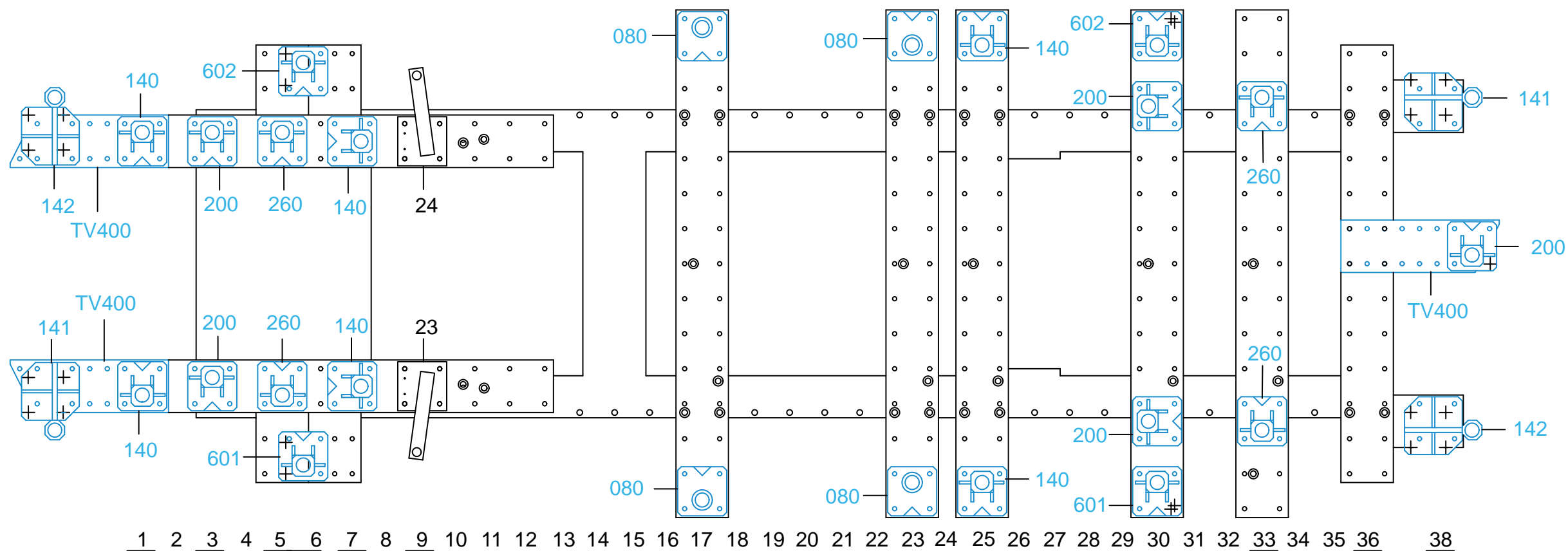

○ Avec ou sans mécanique  
 With or without mechanical elements  
 Con o senza parti meccaniche  
 Mit oder ohne Aggregate  
 Con ó sin mecanica desmontada

**VAS 6240-6**

**2010.306**

21 Kg | 05.12.2005 | 438-D-32C

2010.306-RVA3-2 | 00

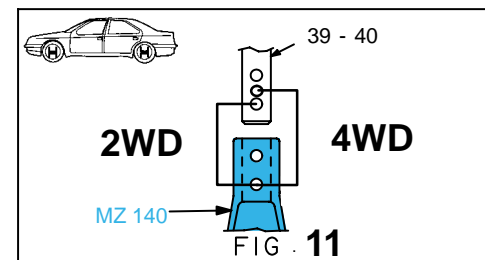
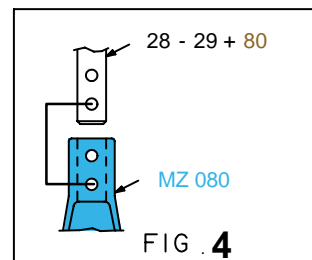
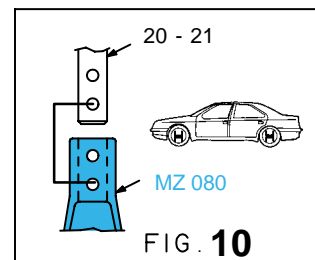
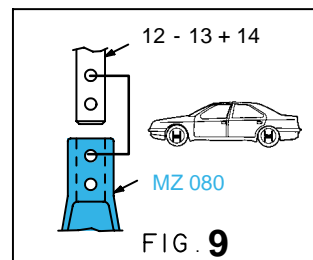
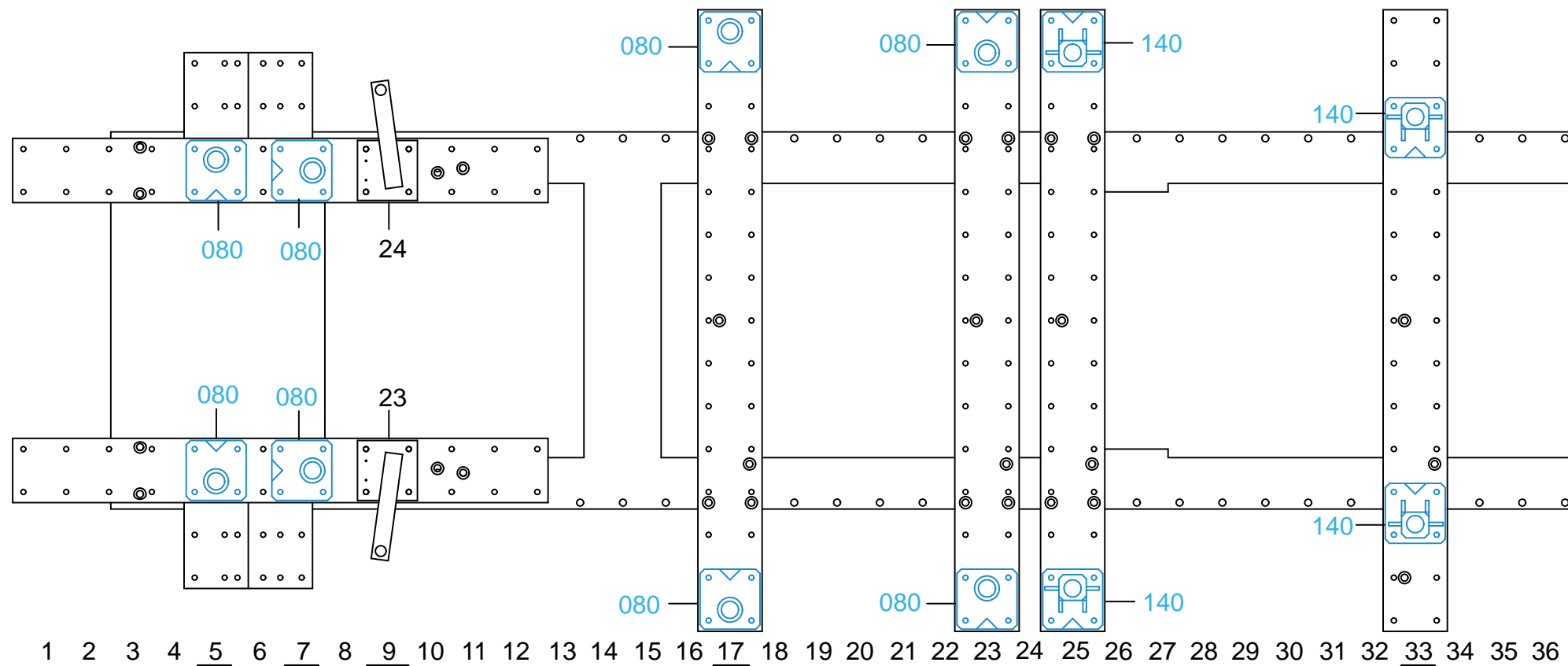

○ Avec ou sans mécanique  
 With or without mechanical elements  
 Con o senza parti meccaniche  
 Mit oder ohne Aggregate  
 Con ó sin mecánica desmontada

**VAS 6240-6**



**2010.306**

21 Kg	05.12.2005	438-D-32D
2010.306-RVA3-2		00