

VAS 6240

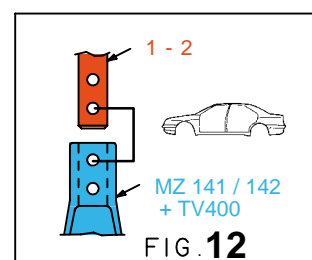

2010.300

89 Kg	02.01.2007	438-D-26B
2010.300-RVA3-1		01

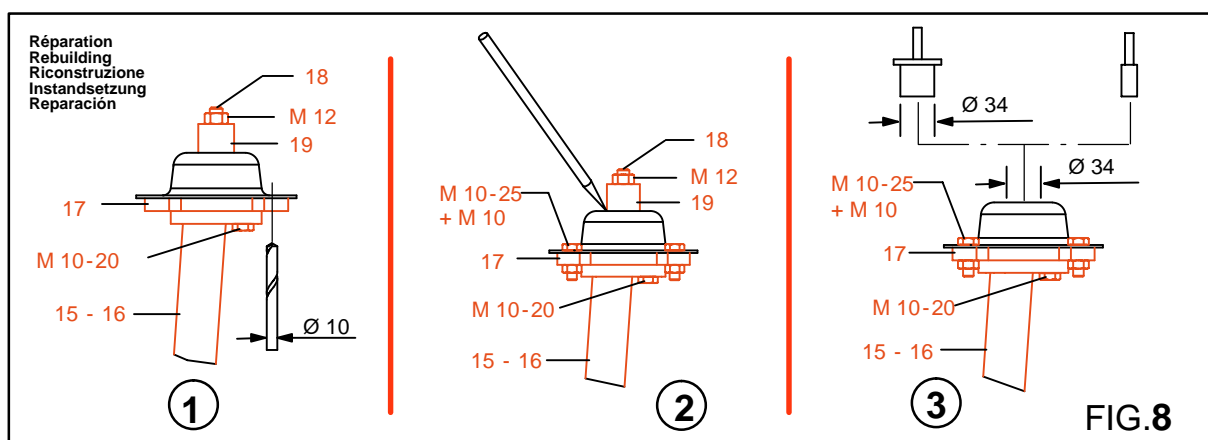
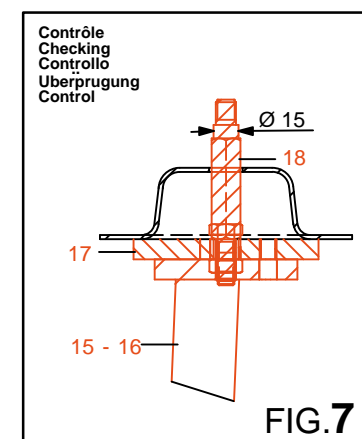
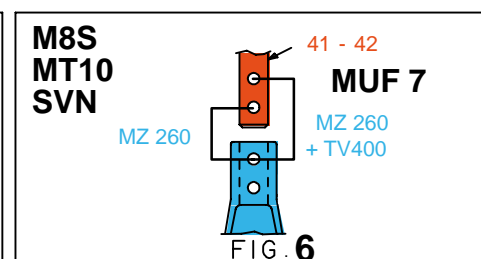
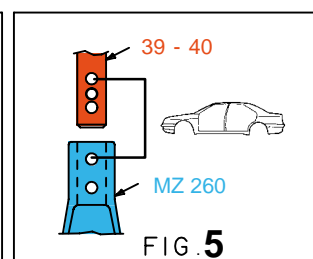
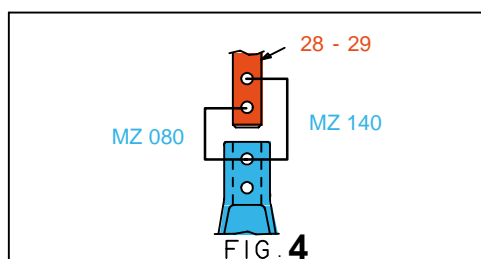
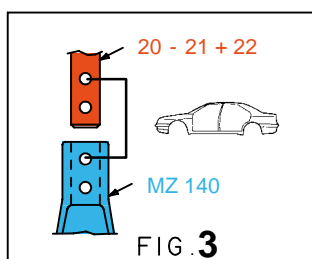
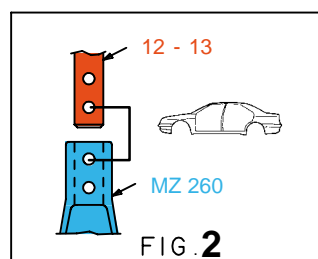
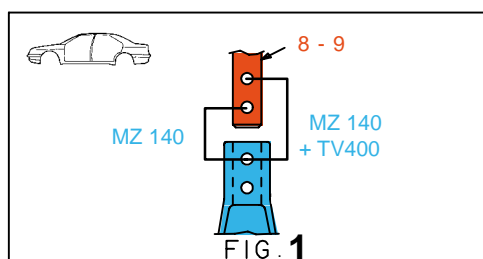
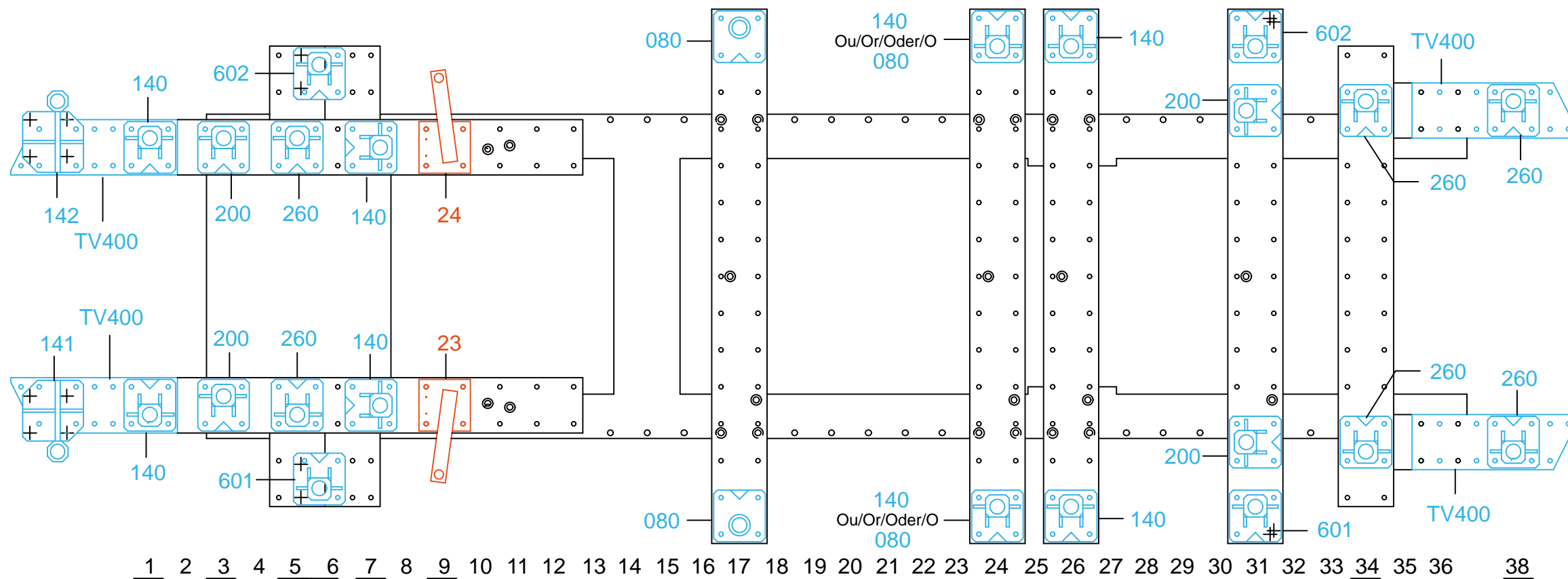
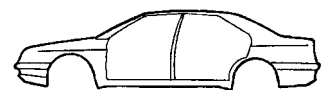

○ Avec ou sans mécanique
 With or without mechanical elements
 Con o senza parti meccaniche
 Mit oder ohne Aggregate
 Con ó sin mecánica desmontada

VAS 6240



2010.300

89 Kg | 02.01.2007 | 438-D-26C

2010.300-RVA3-2 | 00

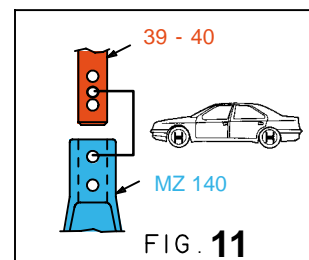
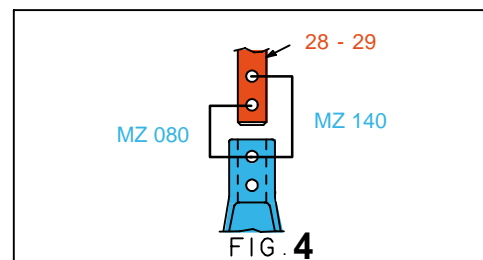
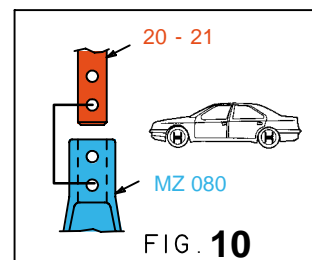
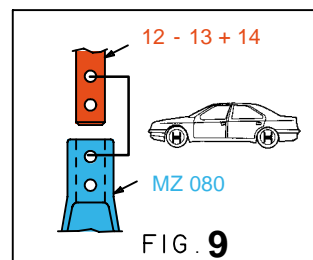
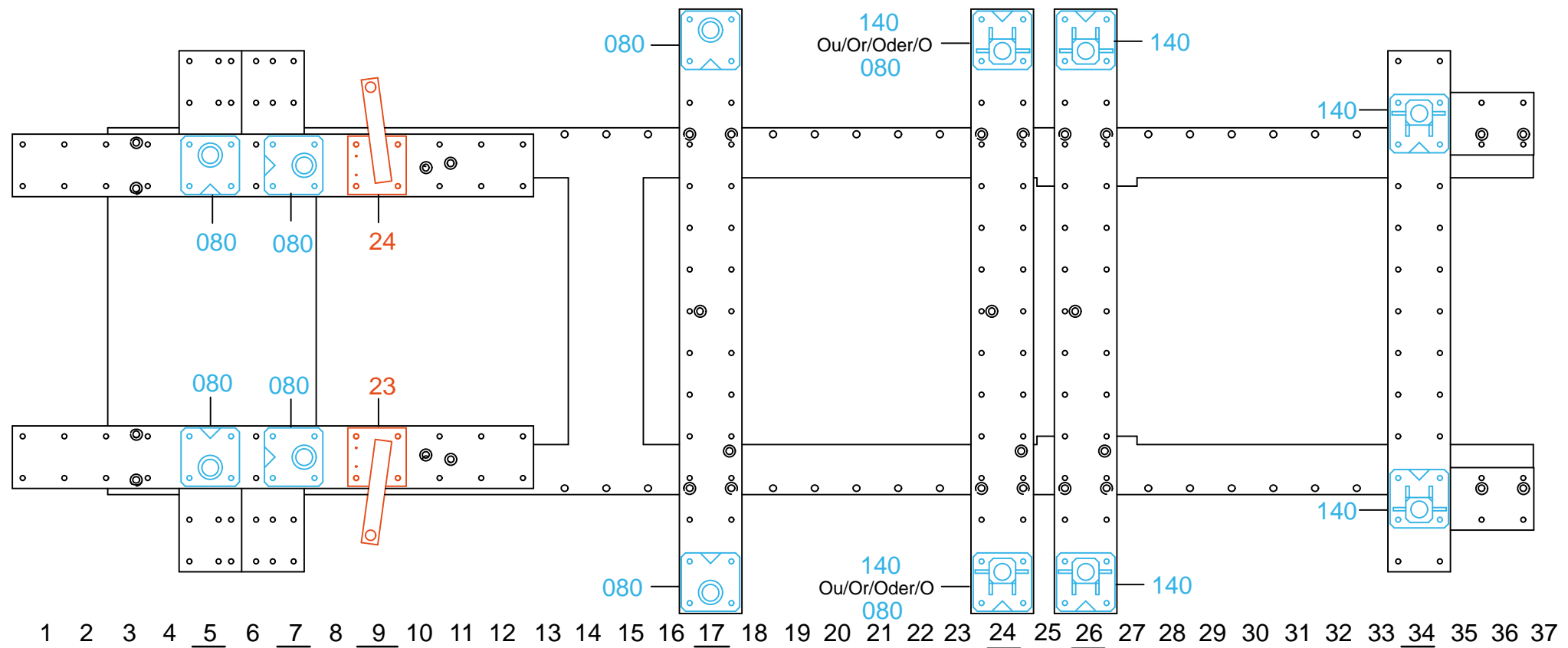

○ Avec ou sans mécanique
 With or without mechanical elements
 Con o senza parti meccaniche
 Mit oder ohne Aggregate
 Con ó sin mecanica desmontada

VAS 6240



2010.300

89 Kg	02.01.2007	438-D-26D
2010.300-RVA3-2		00