

○ Avec ou sans mécanique
With or without mechanical elements
Con o senza parti meccaniche
Mit oder ohne Aggregate
Con ó sin mecanica desmontada

VOLVO

REP.	REFERENCE	PDS	NB	MZ
1	2009.7001	1,7	1	080
2	2009.7002	1,7	1	080
3	2009.7003	1,6	1	080
4	2009.7004	1,6	1	080
5	2009.7005	4,1	1	080
6	2009.7006	4,1	1	080
7	784.7007	0,4	4	
8	784.7008	0,1	4	
9	2009.7009	2,5	1	260/140
10	2009.7010	2,5	1	260/140
20	784.7020	0,4	2	
21	784.7021	0,2	2	
26	784.7026	0,8	2	
55	784.7055	3,0	1	200
56	784.7056	3,0	1	200
57	784.7057	3,0	1	200
58	784.7058	3,0	1	200
59	784.7059	1,7	1	141
60	784.7060	1,7	1	142
61	784.7061	2,6	1	601
62	784.7062	2,6	1	602
63	784.7063	1,3	2	
64	784.7064	1,6	1	080
65	784.7065	1,6	1	080
66	784.7066	2,8	1	200
67	784.7067	2,8	1	200
68	784.7068	1,8	1	
69	784.7069	1,8	1	
	V.32	0,1	2	
	V.11	0,1	2	

M 6-16	6
M 8-25	2
M 10-25	4
M 10-60	2
M 12-25	4
M 12-40	2
M 12-65	2
M 12-110	4
M 14-140	4

LU 6	6
MU 12	4

2009.300

62 Kg 05.12.2002 439-D-12A

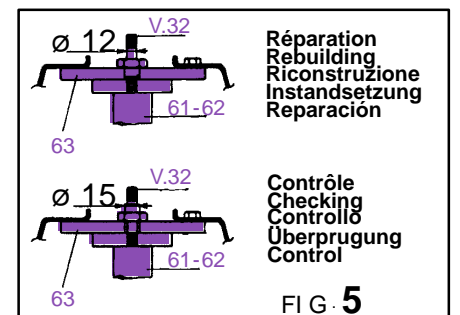
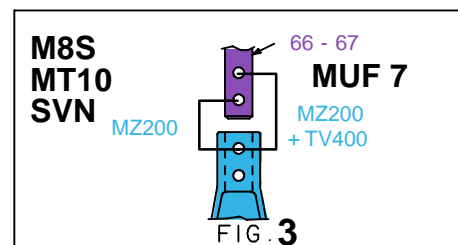
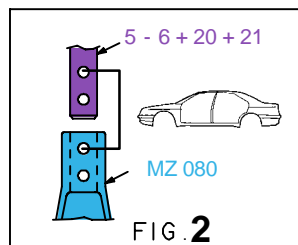
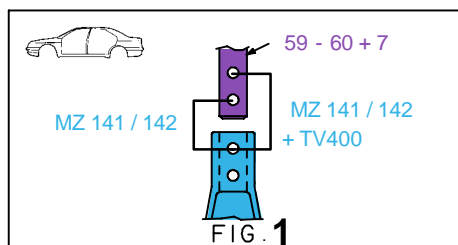
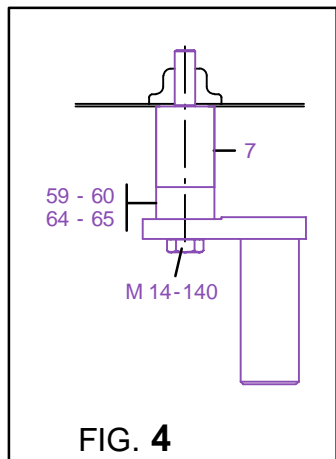
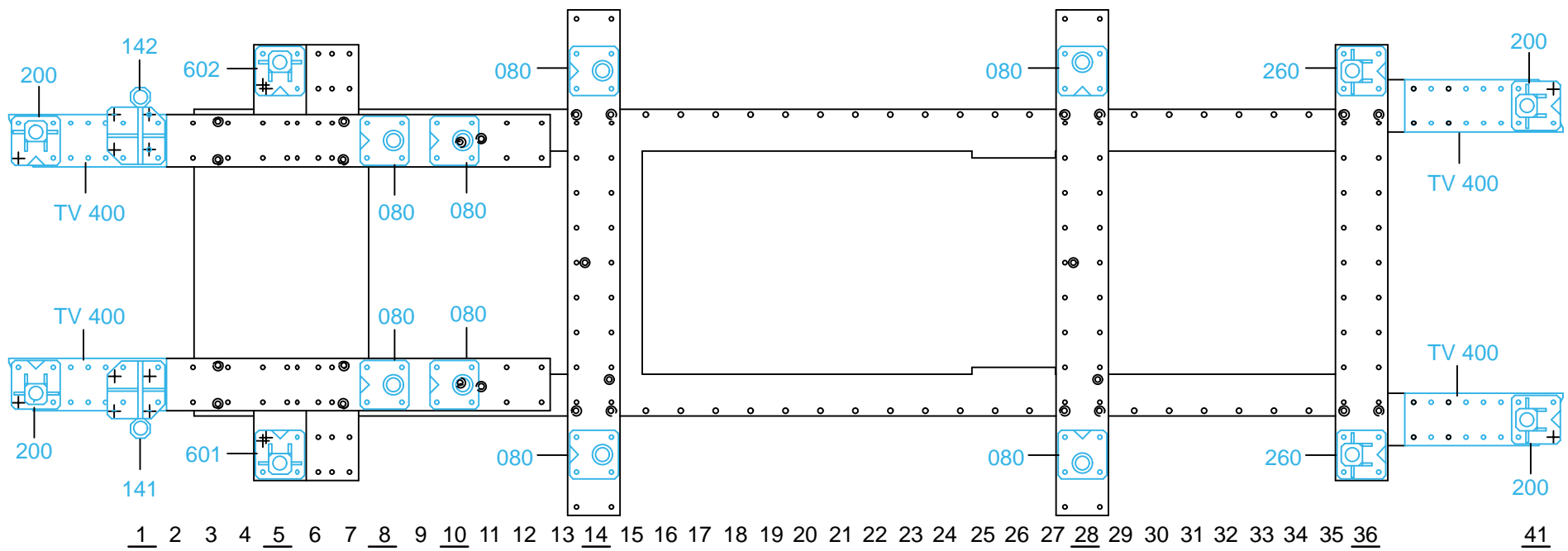

2009.300-RVA3-1 00

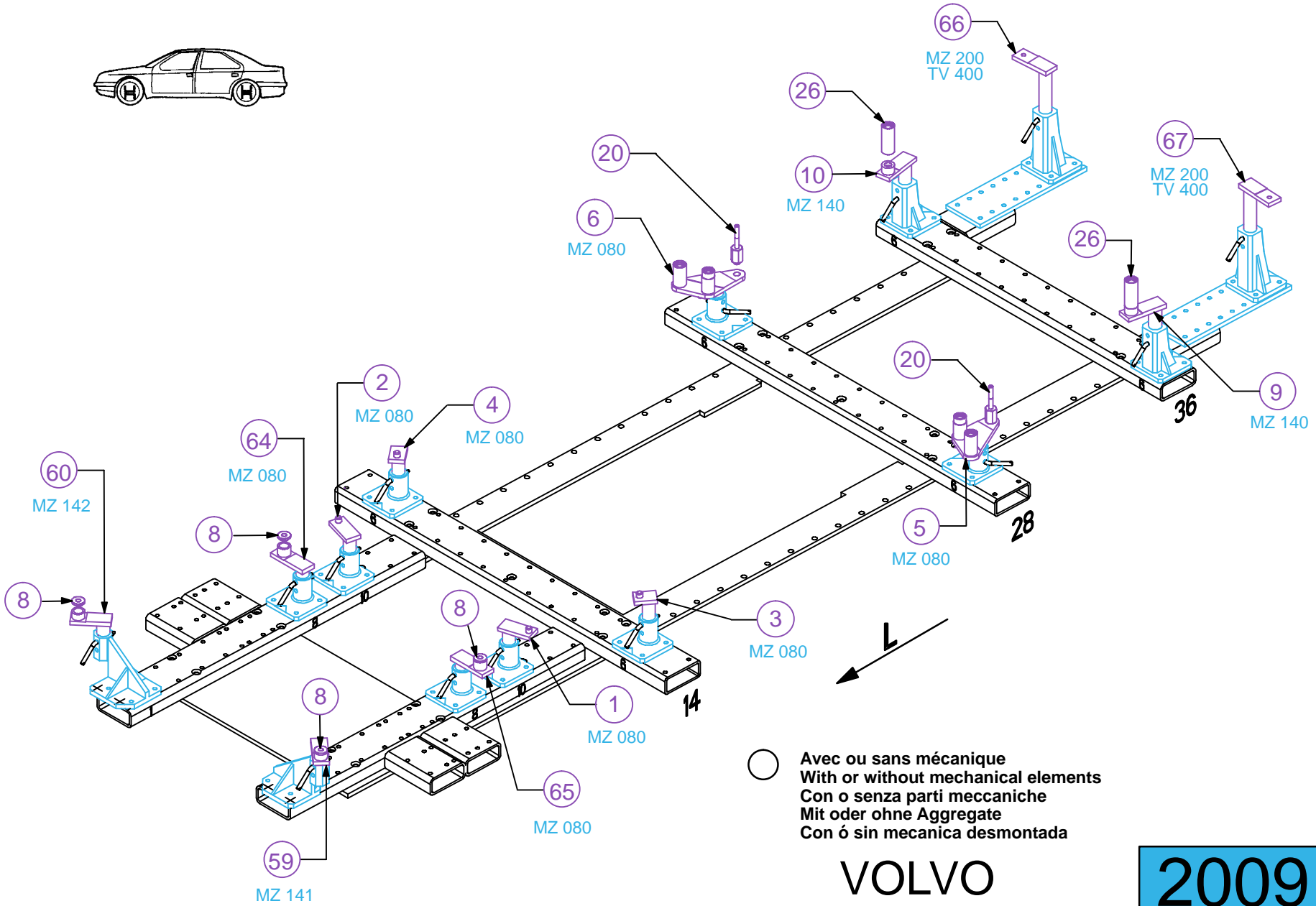
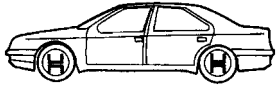

○ Avec ou sans mécanique
 With or without mechanical elements
 Con o senza parti meccaniche
 Mit oder ohne Aggregate
 Con ó sin mecanica desmontada

VOLVO

2009.300

62 Kg	05.12.2002	439-D-12B
-------	------------	-----------

