

ANCRAGE DU VEHICULE
ANCHORING OF THE VEHICLE
VERANKERUNG DES FAHRZEUGS
ANCORAGGIO DEL VEICOLO
ANCLAJE DEL VEHICULO

AN.27.B + AN27.03
Ou/Or/Oder/O
AN.34

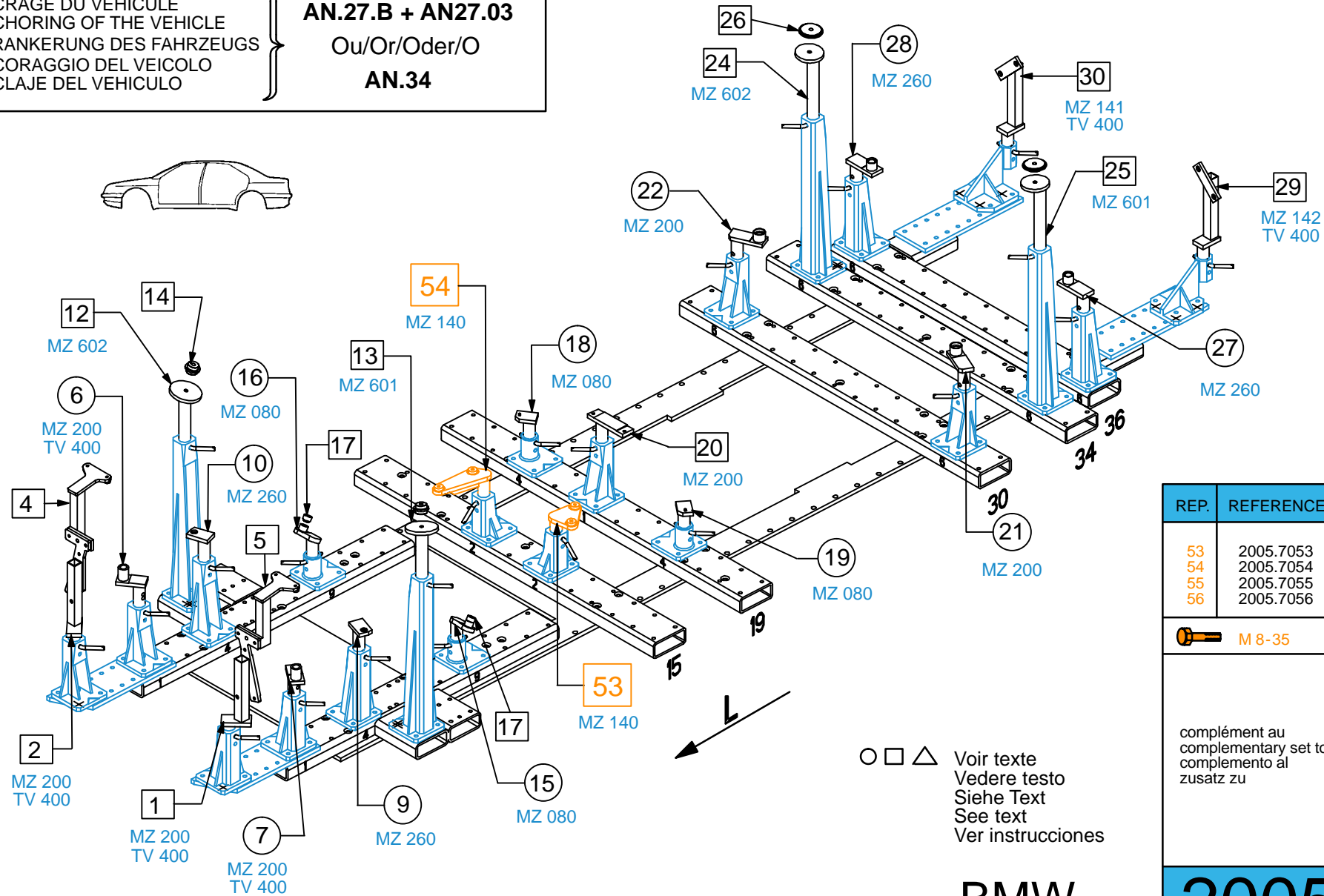

REP.	REFERENCE	PDS	NB	MZ
53	2005.7053	2,2	1	140
54	2005.7054	3,0	1	140
55	2005.7055	1,0	2	
56	2005.7056	0,05	2	

M 8-35 4

-E60-
2005.300

complément au
complementary set to
complemento al
zusatz zu

-E61-
2005.300 +
2005.305

BMW

2005.303

8 Kg 14.12.2005 406-D-21M

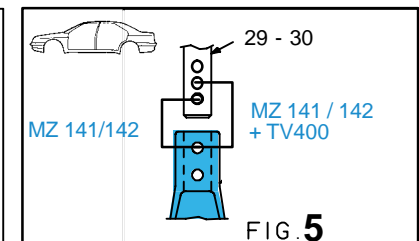
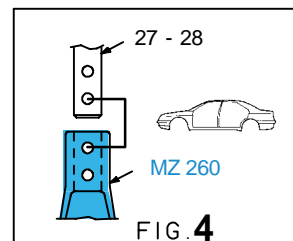
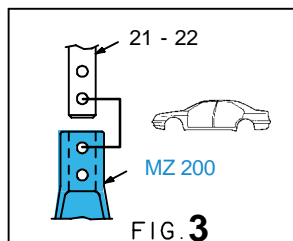
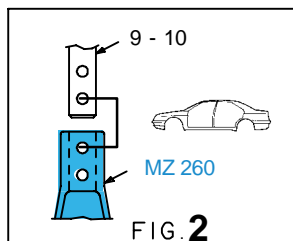
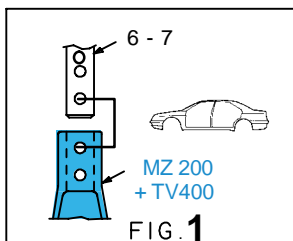
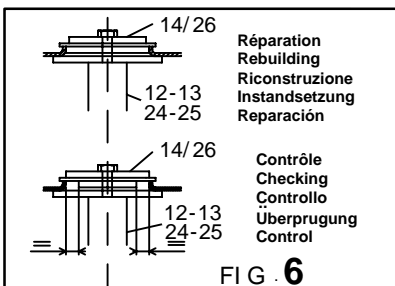
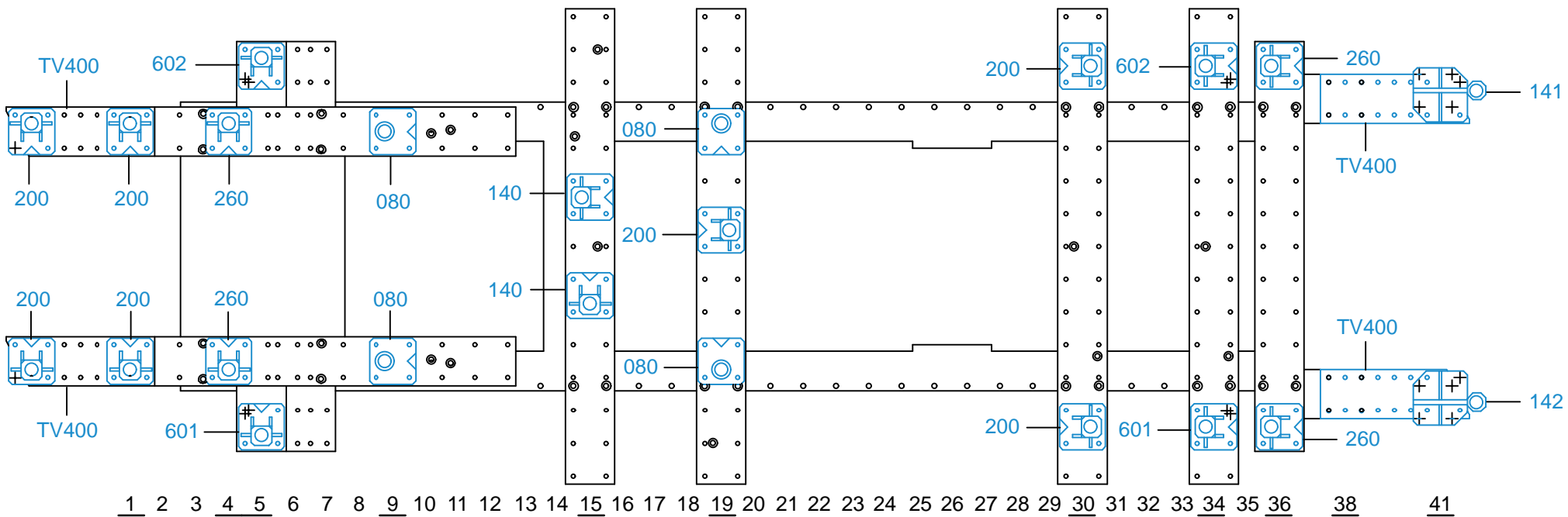

2005.303-RVA3-1 00

ANCRAGE DU VEHICULE
ANCHORING OF THE VEHICLE
VERANKERUNG DES FAHRZEUGS
ANCORAGGIO DEL VEICOLO
ANCLAJE DEL VEHICULO

AN.27.B + AN.27.03
Ou/Or/Oder/O
AN.34

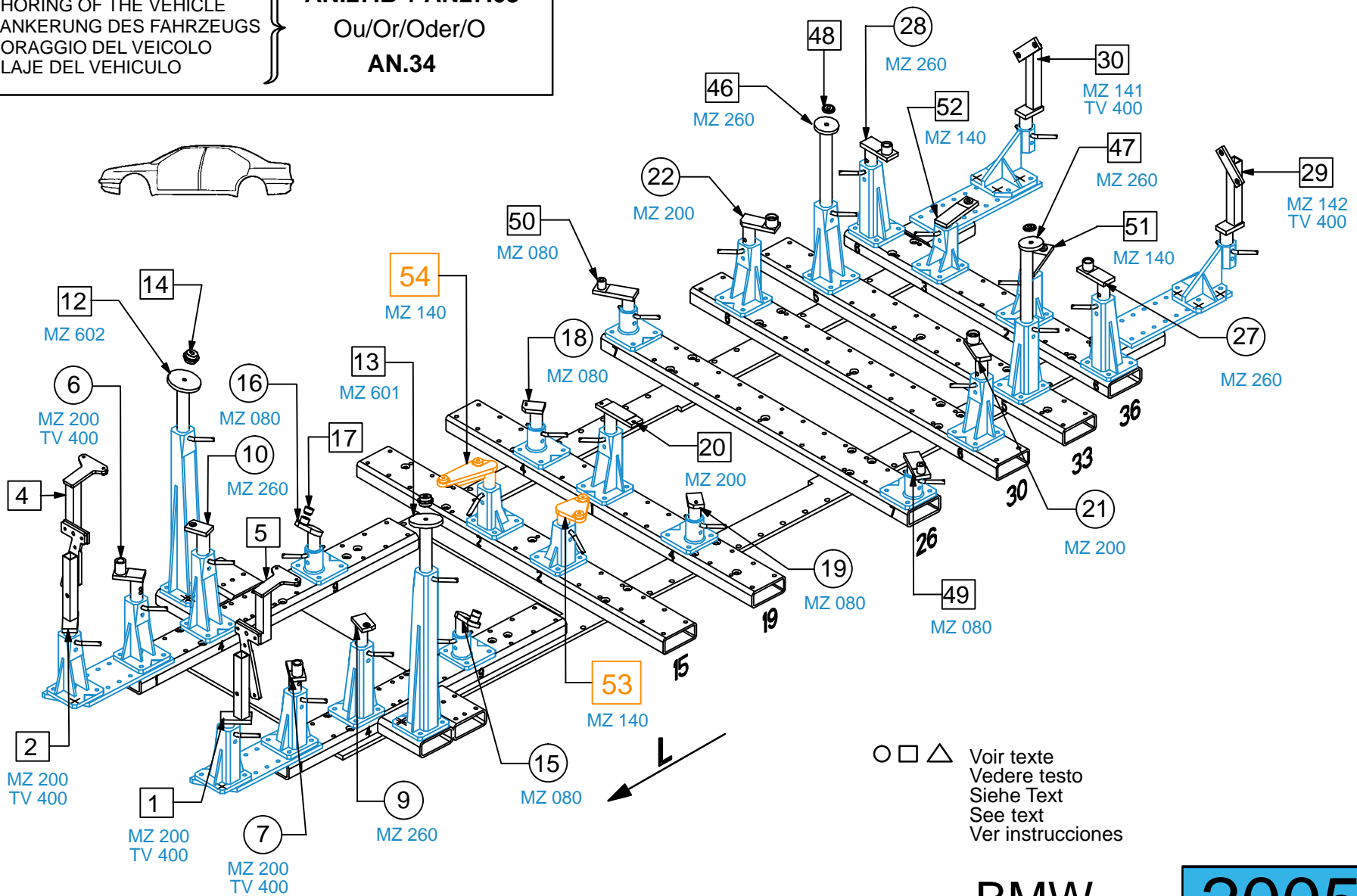

BMW

2005.303

8 Kg 14.12.2005 406-D-21N

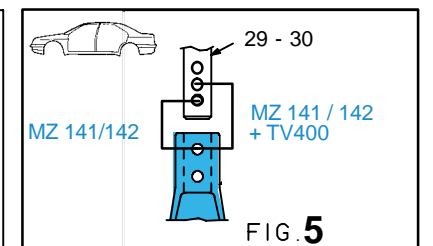
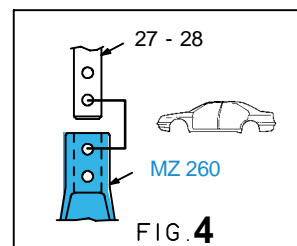
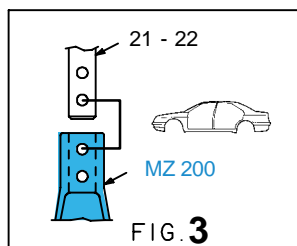
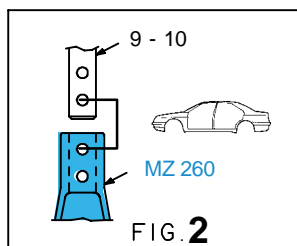
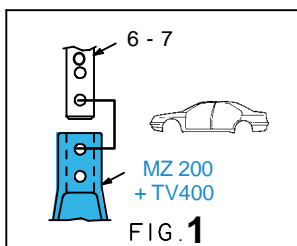
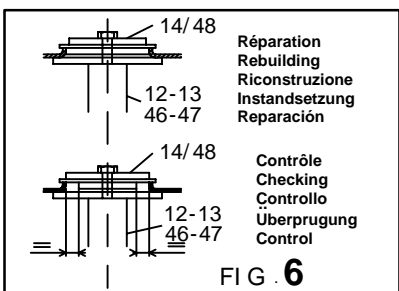
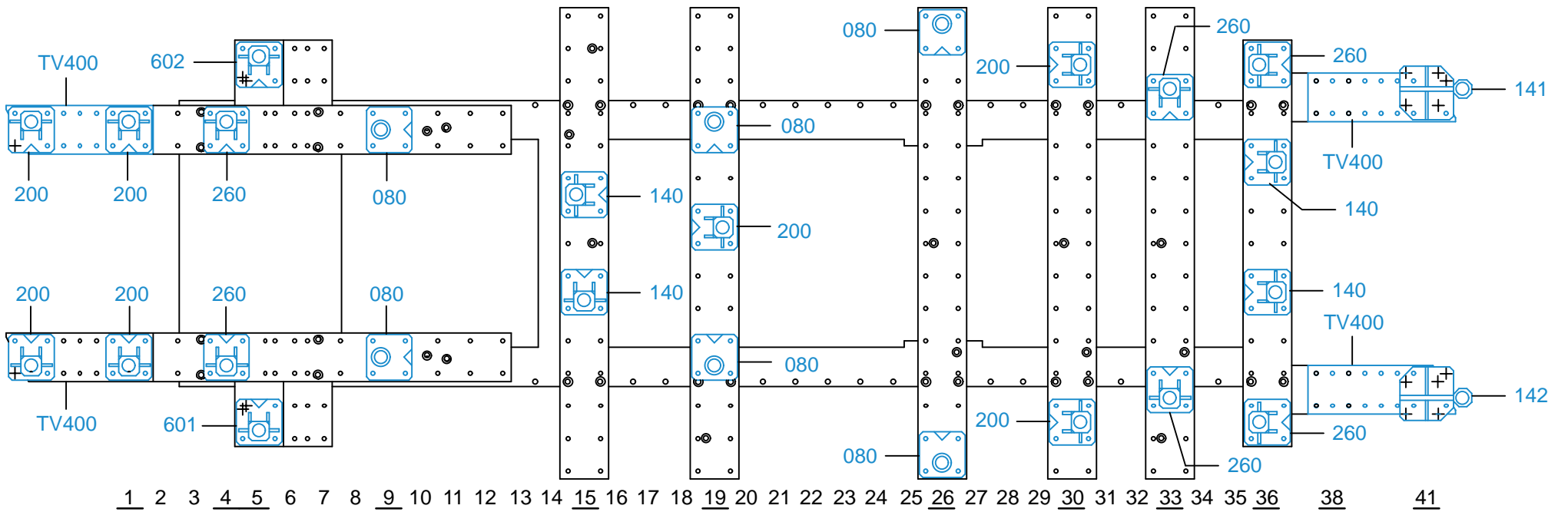

ANCRAGE DU VEHICULE
ANCHORING OF THE VEHICLE
VERANKERUNG DES FAHRZEUGS
ANCORAGGIO DEL VEICOLO
ANCLAJE DEL VEHICULO

AN.27.B + AN27.03
Ou/Or/Oder/O
AN.34

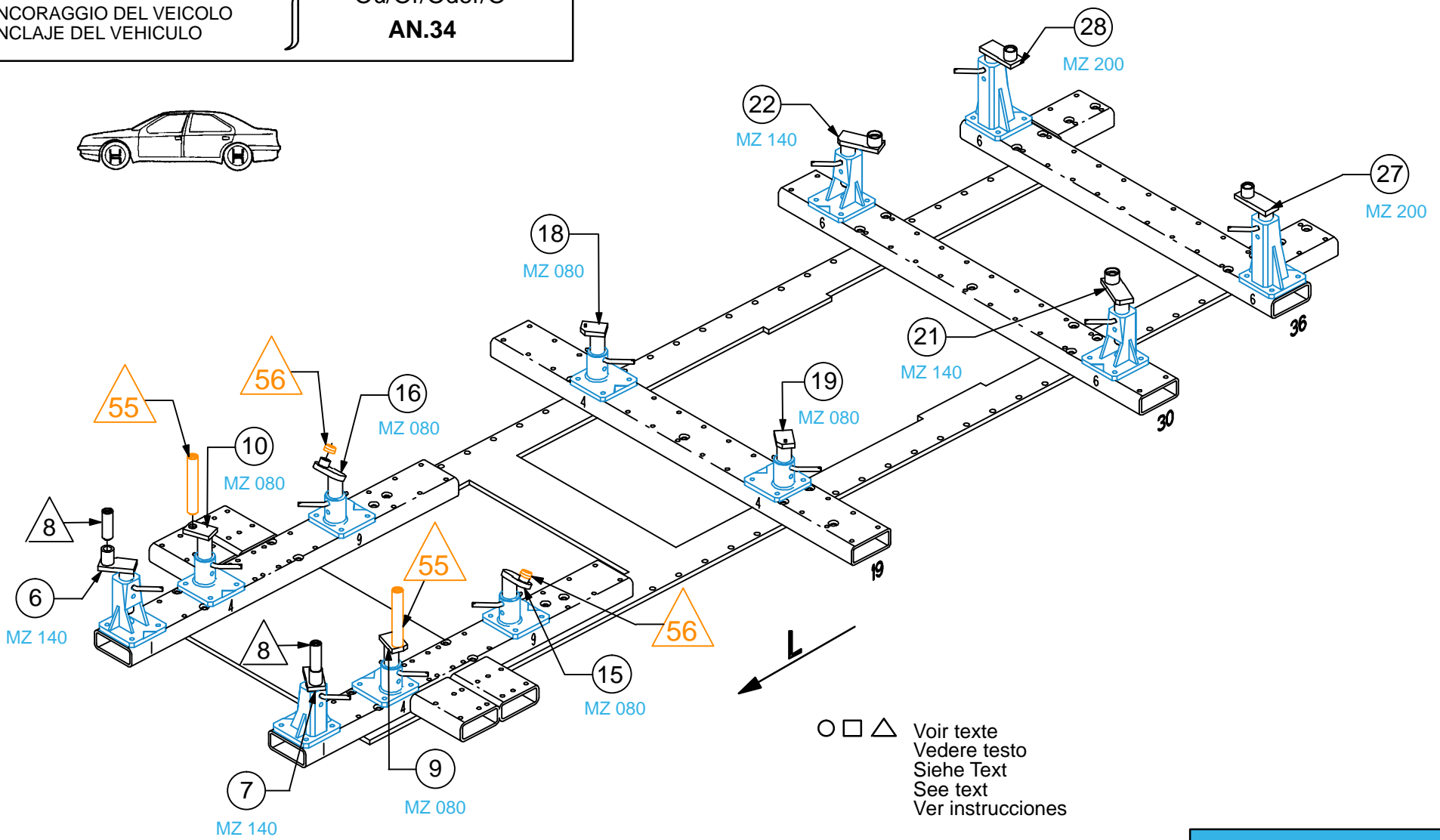

BMW

2005.303
8 Kg 14.12.2005 406-D-21P

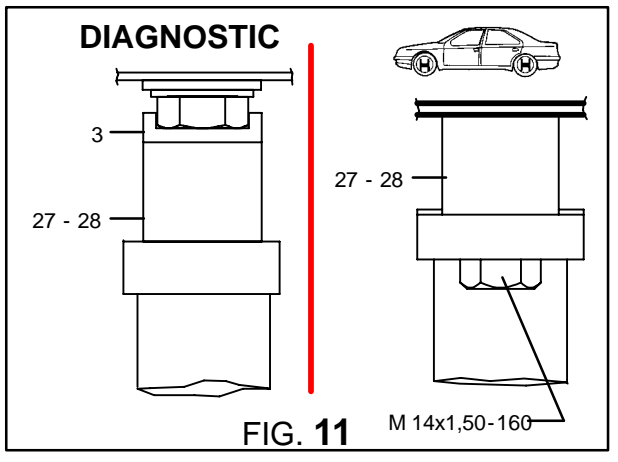
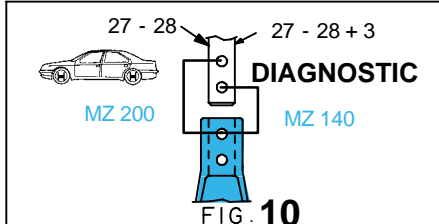
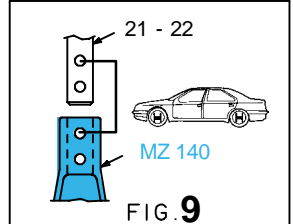
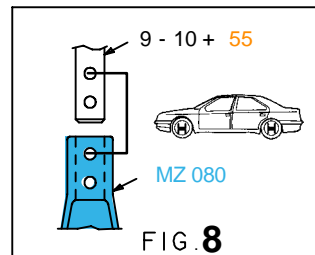
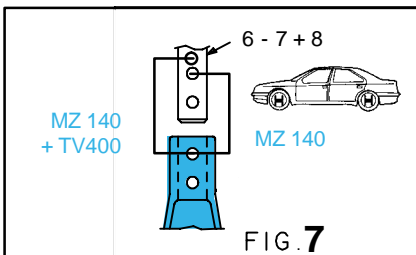
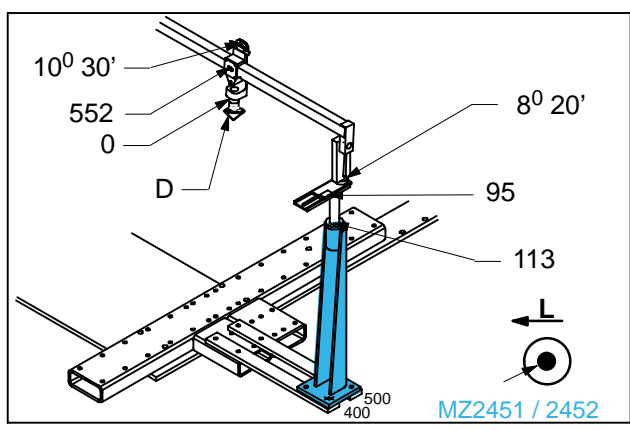
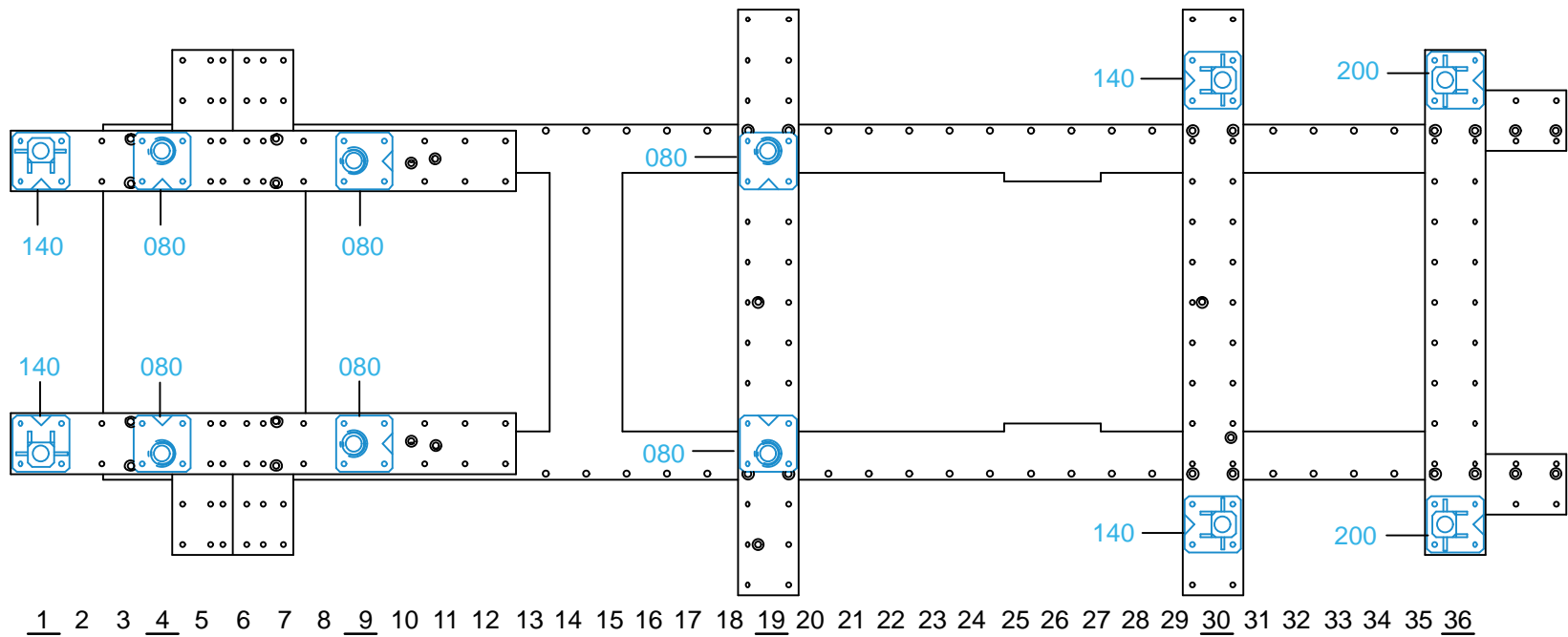

2005.303-RA3-2 00